



Recovery Unit
NRRD
User Manual



NAVAC Inc.
T +1 201.939.6699
F +1 201.939.3899
www.NavacGlobal.com



Failure to follow warnings could
result in death or serious injury.
**SAVE THIS MANUAL
FOR FUTURE REFERENCE**

TABLE OF CONTENTS

GENERAL SAFETY	01
OPERATION MANUAL	02
SPECIFICATIONS	04
CONTROL PANEL	05
PARTS DIAGRAM	06
WIRING DIAGRAM	07
OPERATING INSTRUCTIONS	
1. Refrigerant Hose Connections	08
2. Recovery Method	09
3. Self-purge Method	10
4. Liquid Push/Pull Method	11
TROUBLESHOOTING	12

GENERAL SAFETY

Use information

1. In order to prolong the life of the recovery unit, please read the operating manual carefully before use, so you fully understand the safety, specifications, as well as operating procedures for the recovery unit.
2. Make sure the product received is the same one you ordered and also the accessory operating manual is included. Please check the product for shipping damage. Contact your local distributor if a problem is found.
3. Read the operating manual carefully and only use the unit according to the product operating procedures.

Notice Classifications

▲ Warning

Indicates procedures that must be strictly followed to prevent hazards to people or equipment.

▲ Notice

Indicates procedures must be strictly followed to prevent damage or destruction of the unit.

Matters Needing Attention

▲ Warning

1. Only a certified technician can operate this recovery unit.
2. Before turning on the recovery unit, make sure the electrical power supply is grounded.
3. When using an extension cord, verify the power cord is properly connected and grounded.
4. Only a qualified electrician can wire circuits according to the code and circuit diagram.
5. Be sure the power is off before examining or repairing the recovery unit.
6. If the original power supply cord is damaged, choose the properly rated replacement, or you may buy the replacement directly from your authorized wholesaler.
7. If the unit stops working, you must disconnect the power before attempting any repairs.
8. Make sure the extension cord is rated for the power supply and amperage of the recovery unit.
9. Only certified refrigerant tanks are to be used. Only use recovery tanks with a minimum working pressure of 45bar (652.6 psi). Do not fill the recovery tank over 80% capacity to make sure that there is enough space for liquid expansion. Overfilling of the tank may cause a violent explosion.
10. Always wear safety goggles and protective gloves while working with refrigerants to protect your skin and eyes from injury from refrigerant gases or liquid.
11. Do not use this equipment near flammable liquids or gasoline.
12. An accurate electronic scale is needed to prevent overfilling the recovery tanks.
13. It's not suitable for class A3 refrigerants and toxic refrigerants of class B2, B3.
14. Be sure the work area is thoroughly ventilated.

▲ Notice

1. Be sure unit is connected to the correct voltage power supply.
2. When using an extension cord it should be minimum of 12 AWG and no longer than 75 feet, otherwise it may cause a voltage drop causing damage the compressor.
3. The input pressure of the unit should not exceed 26bar (377.1psi).
4. The unit needs to be horizontal with the correct side up, otherwise it will lead to vibration, noise or even physical damage.
5. Do not expose the equipment to heat of direct sun, and cover if used in the rain.
6. The ventilation opening of the unit must not be blocked.
7. If the overload protection opens, allow at least 5 minutes before attempting to reset.
8. If this unit has an oil separator device, it will only clean the refrigerant during vapor recovery process and recycling of the refrigerant through the machine.
9. When recovering more than 17.6 lbs of vapor, you will need to remove oil from the oil separator device. This must be done with system pressure at no more than atmospheric pressure.

OPERATION MANUAL

1. Do not mix different refrigerants together in one tank. They cannot not be separated or used.
2. Before recovering refrigerant, the recovery tank should be under vacuum level of 29.6", which is for purging non-condensable gases. Each tank was full of nitrogen when it was manufactured and must be evacuated before the first use.
3. The switch should be at Off Position before operation. All valves must be closed, the input and output fittings should be covered with protective caps when the unit is not in operation, as air and moisture are harmful to the recovery machine, shortening the life span of the unit.
4. A filter-drier should always be used and should be replaced frequently. You must change the filter-drier when recovering different refrigerants. To insure normal operation of the unit, use only filter-driers specified by NAVAC. High quality filter driers will give the best service.
5. Special caution is needed when recovering refrigerant from a shorted system, and two filter- driers are needed.
6. This unit has an Internal High Pressure Shut-Off switch. If the pressure inside the system is above the rated shut-off pressure (see specification), compressor will automatically shut off and the high pressure alarm light will turn on. To restart the compressor, lower the internal pressure (output gauge shows less than 30 bar/435.1 PSI). After the high pressure alarm light turns off, press the reset button, and turn on power to restart the compressor.
If the high pressure protection trips, please find out the cause and fix it before restarting the unit.

Cause of High Pressure Protection and Troubleshooting:

1. The input valve of the refrigerant tank is closed—open the valve will help solve the problem.
2. The connecting hose between the recovery unit and refrigerant tank is plugged — close all valves and replace the connecting hose.
3. The temperature of the refrigerant tank is too high, pressure is too high—chill the tank with ice or give it time to cool down and the pressure will come back to normal.

7. This recovery machine can be used with tanks that have a float level sensor. Connect the recovery unit and the tank with the 80% O.F.P. Cable. When the liquid refrigerant reaches 80% capacity of the tank, the recovery unit will automatically shut off and the Red Alarm Light turns on. Before restarting, change an empty tank.
8. Please press button when start or stop the unit. The light is on when compressor runs.
9. If the refrigerant tank has no float level sensor, please take the 80% O.F.P Cable off. Otherwise the recovery unit will not start. In this case, an electric scale is required to monitor the recovered refrigerant weight. **DO NOT OVERFILL THE TANK!**
10. In order to get maximum recovery speed, a hose with inner diameter bigger than 5/32" is recommended, and should be 5 feet or shorter.
11. While recovering large amounts of liquid, use the Push/Pull Mode.
12. After recovery, make sure no refrigerant is left in the unit. Follow the Purge Operation carefully. Liquid refrigerant remaining in the unit may expand and damage the components.
13. If the unit is to be stored or not used for any length of time, we recommend that it be completely evacuated of any residual refrigerant and purged with dry nitrogen.
14. Connection hoses with check valves are recommended to prevent refrigerant loss.
15. The intake port is equipped with filter screen, so clean it frequently.
16. The Low Pressure Gauge shows the pressure of the intake port of the compressor and the High Pressure Gauge shows the pressure of the outlet port of the recovery unit.
17. After use, turn the knob to Off position.

SPECIFICATIONS

NRRD				
Refrigerant Type	Category III: R-12, R-134a, R-401C, R-500 Category IV: R-22, R-401A, R-401B, R-402B, R-407C, R-407D, R-408A, R-409A, R-411A, R-411B, R-412A, R-502, R-509 Category V: R-402A, R-404A, R-407A, R-407B, R-410A, R-507			
Power Supply	110V / 60Hz			
Motor	1 HP			
Max Current Draw	10 A			
Compressor	Oil-less, Air-cooled, Piston style			
Automatic Safety Shut-Off	558 psi / 38.5 bar			
Recovery Rate		R-22	R-134a	R-410a
	High Temp Vapor	0.46		
	Direct Vapor	0.49	0.35	0.33
	Direct Liquid	4.3	4.1	5.64
	Push / pull Liquid	11.66	9.3	16.71
Dimension	18" x 10" x 14"			
Weight	30 lbs			

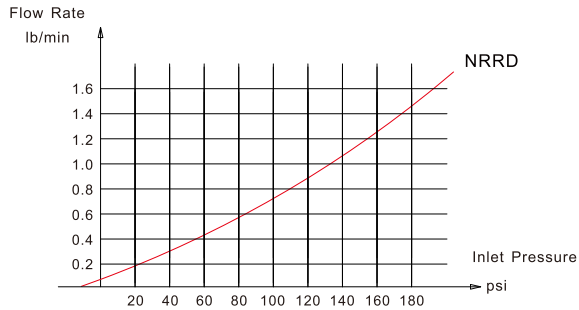

▲ Notice
The flow rate of vapor is direct proportion to inlet pressure.

CONTROL PANEL

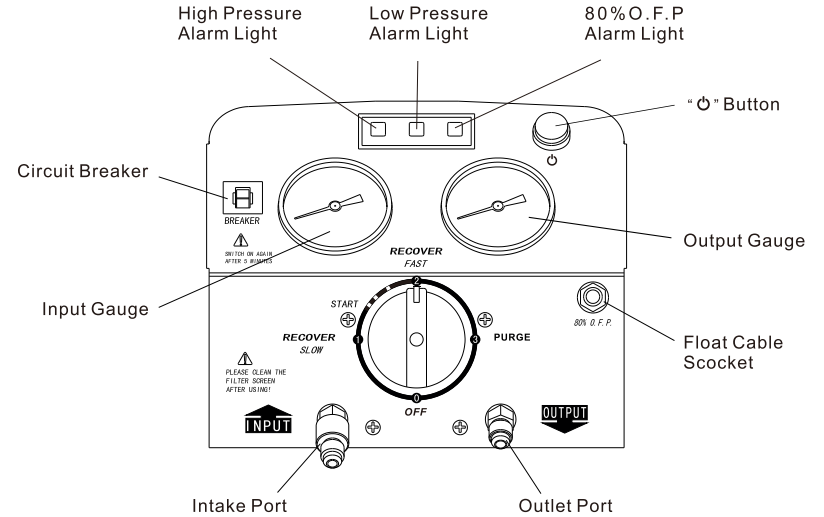

PARTS DIAGRAM

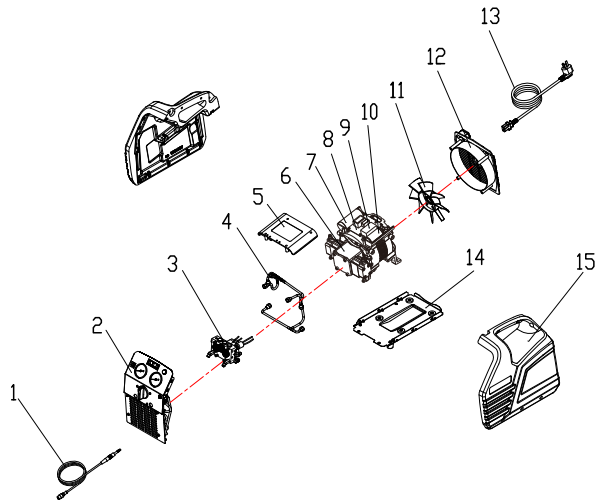

No.	Component
1	O.F.P.Cable
2	Front Panel
3	Control Valve
4	Copper Pipes
5	Junction Box Cover
6	Compressor
7	Running Capacitor
8	Circuit Board

No.	Component
9	Electronic Starter
10	Starting Capacitor
11	Fan
12	Fan Cover
13	Power Supply Cord
14	Base
15	Cover

WIRING DIAGRAM

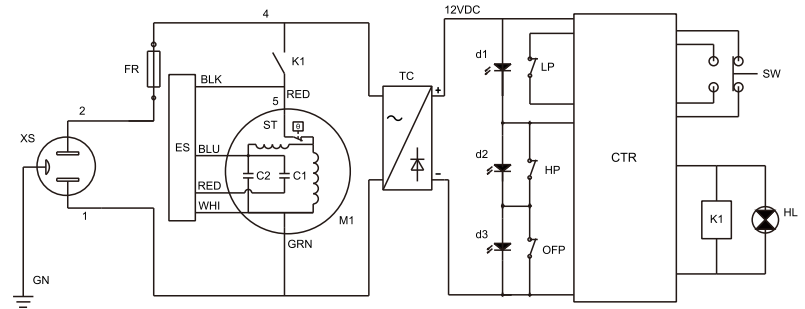

No.	Graphics Code	Component
1	XS	Power Outlet
2	FR	Overload Protection Device
3	ES	Electronic Starter
4	M1	Compressor Motor
5	C1	Start Capacitor
6	C2	Running Capacitor
7	ST	Motor Thermal Potectors
8	TC	Electronic Transformer
9	HP	High Pressure Switch

No.	Graphics Code	Component
10	LP	Low Pressure Switch
11	OFF	80% O.F.P. Switch
12	d1	Green Indicator
13	d2, d3	Red Indicator
14	SW	Power Button
15	HL	Indicating Lamp
16	CTR	Control Moduel
17	K1	Relay
18		

OPERATING INSTRUCTIONS

1. Refrigerant Hose Connections

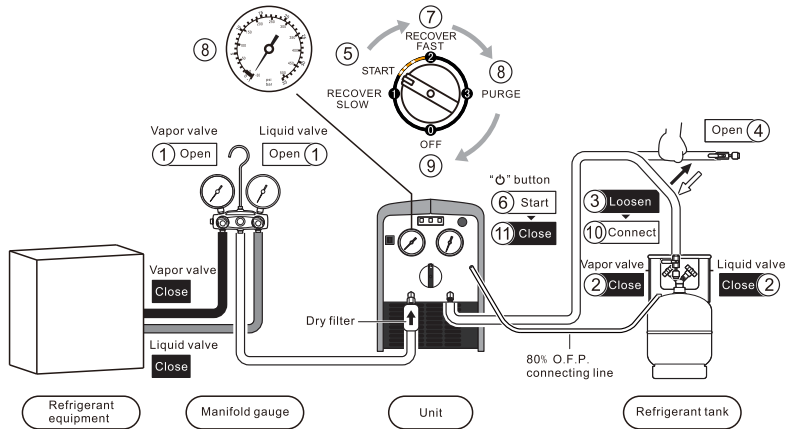

Ready for operation

1. Connect hoses correctly and tight, referring to the connection diagram.
2. Open the vapor and liquid valves of manifold gauge.
3. Loosen the connecting hoses of refrigerant tank.
4. Open the valve to the hoses.

Start operation

1. Turn the switch to position START.
2. Press **O** button.
3. Turn the switch to position 2 and start purging the air out of the hoses.
4. While the input gauge getting to 15" of vacuum (-1 bar) turn the switch to position 3 to start self-purge.
5. While the input gauge getting to 15" (-1 bar) again, turn the switch to position 0 to finish self-purge.
6. Tighten the hoses at refrigerant tank.

Finish operation

1. Press **O** button.

OPERATING INSTRUCTIONS

2. Recovery Mode

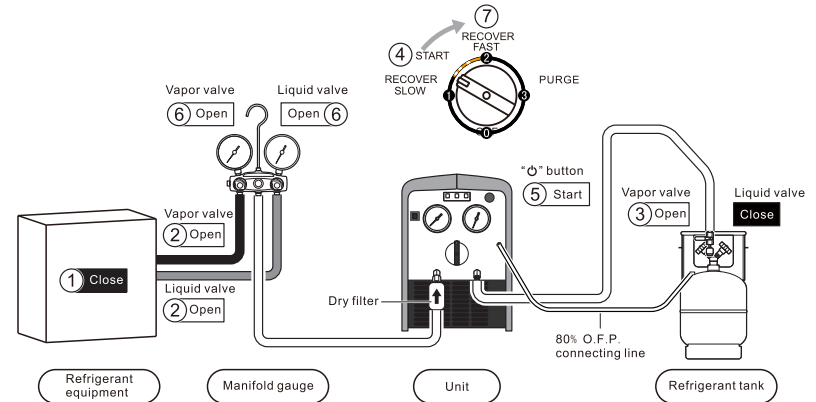

Ready for operation

1. Connect hoses correctly and firmly. (Please refer to the connection diagram)
2. Make sure all valves are closed.
3. Turn off the power to system equipment.
4. Open the vapor and liquid valves of refrigeration or air conditioning system equipment.
5. Open the vapor valve of the refrigerant tank.

Start operation

1. Turn the switch to the position START.
2. Press **O** button.
3. Open the liquid valve for liquid recovery. Open the vapor valve for vapor recovery.
4. Turn the switch slowly to position 2 for faster recovery.
5. When the recovery is finished, the unit gets to the required vacuum or automatically stops by low pressure protection.

▲ Notice

1. If compressor liquid slugging occurs at position 2, turn the switch to position "START" until the liquid slugging stops.
2. If the recovery restarts after interruption of power or fails to start,
 - 2.1 Turn the switch to position START, turn on the power switch, press START button for liquid recovery.
 - 2.2 Turn the switch to position 3, turn on the power switch, press START button for vapor recovery.

▲ Notice

1. Turning the switch to position 1 gets a stable recovery of liquid with low speed of 1.2kg/Min.
2. If compressor slugging occurs at the position 1 turn the switch slowly to position START until slugging stops. Make sure the pressure is at zero, because it doesn't work at 10.
3. There is no need to turn off the power and it can do the self-purge cycle automatically.

OPERATING INSTRUCTIONS

3. Self-purge Mode

⚠ Notice

The unit must be purged after each use;
Liquid refrigerant remained may expand and damage the
components and pollute the environment.

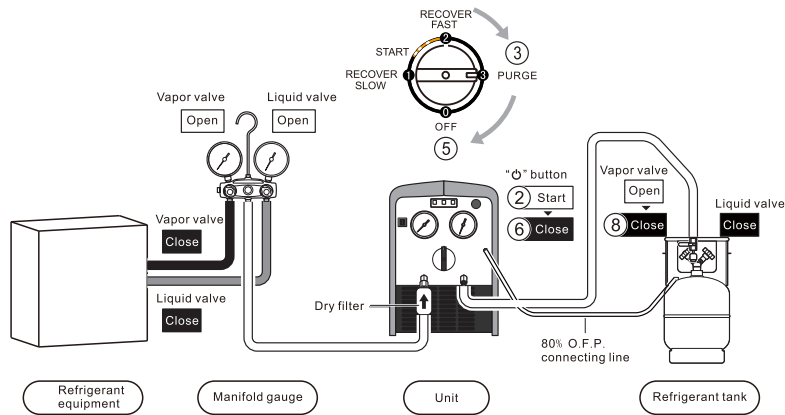

Ready for operation

1. The unit stops automatically when recovery is finished.
2. Press 0 button.
3. Turn the switch slowly to position 3 to start purge.
4. When the self-purging cycle is finished, the unit goes into a vacuum.

Finish operation

1. Turn the switch to position 0.
2. Press 0 button.
3. Close the check valve to hoses.
4. Turn off the vapor valve of refrigerant tank.

OPERATING INSTRUCTIONS

4. Liquid Push/Pull Mode

⚠ Notice

An electric scale is needed to
monitor the recover process to
prevent overfilling.

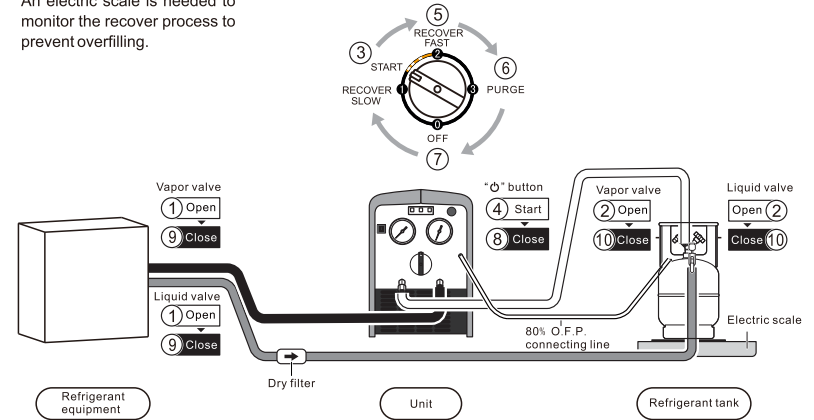

Ready for operation

1. Connect the hoses correctly and firmly.
(Please refer to the connection diagram)
2. Make sure all valves are closed.

Start operation

⚠ Warning

When the electric scale shows that the refrigerant in
the tank has reached 80% capacity, turn the power
off and close the tank valves.

1. Open the vapor and liquid valves of the
system equipment.
2. Open the vapor and liquid valves of the
recovery tank.
3. Turn the switch to position START.
4. Press 0 button.
5. Turn the switch to position 2 to start
push/pull mode. When the display of electric
scale stops rising or increases very slowly, it

means the liquid recovery is finished, and it
is time to switch to vapor recovery.

6. Turn the switch to position PURGE and follow
self-purge mode instructions to purge the
refrigerant vapor.
7. Turn the switch to position OFF.
8. Press 0 button.
9. Close the vapor and liquid valves of the
system equipment
10. Close the vapor and liquid valves on the
recovery tank.
11. Connect the hoses again and recover the
vapor from the system equipment according to
recovery mode instructions.

