

# Vission 20/20™ Micro-controller

Operation and service manual • Version 2.7





# Important Message

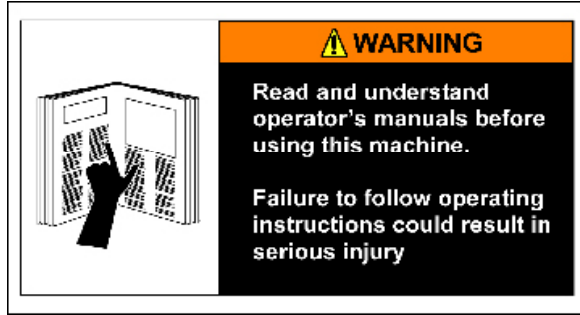

**READ CAREFULLY BEFORE OPERATING YOUR COMPRESSOR.**

The following instructions have been prepared to assist in operation of Vilter™ Vission 20/20™ micro-controllers.

The entire manual should be reviewed before attempting to operate.

**Vilter™ micro-controllers are thoroughly inspected at the factory. However, damage can occur in shipment. For this reason, the equipment should be thoroughly inspected upon arrival. Any damage noted should be reported immediately to the Transportation Company. This way, an authorized agent can examine the unit, determine the extent of damage and take necessary steps to rectify the claim with no serious or costly delays. At the same time, the local Vilter™ representative or the home office should be notified of any claim made.**

All inquires should include the Vilter™ sales order number, compressor serial and model number. These can be found on the compressor nameplate on the compressor.

All requests for information, services or parts should be directed to:

**Vilter™ Manufacturing LLC**  
Customer Service Department  
5555 South Packard Ave  
Cudahy, WI 53110 USA  
Telephone: 1-414-744-0111  
Fax: 1-414-744-3483  
E-mail: info.vilter@emerson.com

Equipment Identification Numbers:

Vilter Order Number: \_\_\_\_\_ Software Version: \_\_\_\_\_  
Vilter Order Number: \_\_\_\_\_ Software Version: \_\_\_\_\_  
Vilter Order Number: \_\_\_\_\_ Software Version: \_\_\_\_\_  
Vilter Order Number: \_\_\_\_\_ Software Version: \_\_\_\_\_





# Table of Contents

---

Section Title	Section Number
Important Message.....	i
How To Use This Manual.....	TOC-12
<b>Section 1 • Operational Flow Charts</b>	
Requirements to Start Compressor .....	1-1
Critical Compressor Run Logic at Compressor Start.....	1-1
Compressor Amperage Load Limiting .....	1-2
High Discharge Pressure Load Limiting.....	1-2
Suction Pressure Override Load Limit During Temperature Control .....	1-2
<b>Section 2 • Installation Recommendations</b>	
Proper Wiring Sizing .....	2-1
Voltage Source .....	2-1
Grounding .....	2-2
Mixing Voltages .....	2-2
DC signals .....	2-2
Wiring Methods.....	2-3
Best Practices.....	2-4
<b>Section 3 • Hardware Architecture</b>	
Overview .....	3-1
Digital Input/Output (I/O).....	3-1
Analog Inputs .....	3-6
Analog Outputs .....	3-7
Digital & Analog I/O Boards Layout.....	3-8
Digital Output Boards .....	3-9
Digital Input Boards .....	3-10
Digital In-Out Boards .....	3-11
Analog Input Boards .....	3-12
Analog Input Jumper Tables .....	3-13
Analog Output Boards .....	3-15
<b>Section 4 • Main Screen</b>	
Overview .....	4-1
Top Status Bar .....	4-2
Parameter Bar.....	4-3
Bottom Status Bar.....	4-5
Splash Screen.....	4-6
Step VI Screen.....	4-7
SOI Solenoid Screen .....	4-8
Configurable Main Screen .....	4-9
<b>Section 5 • Menu Screen</b>	
Overview .....	5-1
Navigation Buttons .....	5-1
<b>Section 6 • Compressor Control</b>	
Overview .....	6-1
Suction Pressure Control, Process Temperature Control, Process Pressure Control and Discharge Pressure Control .....	6-1
Auto-Cycle .....	6-2

# Table of Contents

Section Title	Section Number
Variable Frequency Drive (VFD).....	6-5
Oil Restriction Solenoid.....	6-7
Rapid Cycling VFD Control.....	6-8
Pumpdown Control.....	6-9
Pulldown Control.....	6-10
Active Control Mode.....	6-11
Load Anticipating.....	6-11
Oil Control.....	6-12
Stop Load & Force Unload.....	6-14
Capacity Slide Triggered Outputs.....	6-15
Volume Slide Position Offset.....	6-15
Soft Load.....	6-16
Liquid Injection.....	6-16
Dual Liquid Injection.....	6-18
Liquid Injection Outlet Port Direction.....	6-19
VI Control - Twin Screw.....	6-20
Fixed VI.....	6-20
Continuos VI.....	6-21
Step VI.....	6-22

## Section 7 • Alarms and Trips

Overview.....	7-1
Warnings.....	7-1
Inhibits.....	7-1
Alarms.....	7-2
Trips.....	7-2
Freeze Screen.....	7-2
Logging - Event List.....	7-2
Setpoints.....	7-2
Add Oil to the Middle Sight Glass.....	7-8
Analog AUX In 1-16.....	7-8
Compressor Interlock Trip.....	7-8
Digital AUX In 1-8.....	7-8
Discharge Pressure	
High Discharge Pressure.....	7-9
Low Discharge Pressure.....	7-9
Discharge Superheat Temperature	
High Discharge Superheat Start Temp.....	7-9
High Discharge Superheat Rise Temp.....	7-9
High Discharge Superheat Run Temp.....	7-10
Discharge Temperature	
High Discharge Temp.....	7-10
Low Discharge Temp.....	7-10
Emergency Shutdown Activated.....	7-10
False Start.....	7-10
Filter Differential Pressure	
High Filter Differential Pressure.....	7-11
Level Shutdown.....	7-11
Motor Current.....	7-11
Oil Filter Inlet Pressure.....	7-12
Low Oil Filter Inlet Pressure.....	7-12
Low Oil Filter Outlet Pressure.....	7-12
High Oil Injection Temp.....	7-12
Low Oil Injection Temp.....	7-12

# Table of Contents

Section Title	Section Number
Oil Level #1 or #2.....	7-12
Oil Level Trip after Stop .....	7-13
Oil Over Pressure .....	7-13
Low Oil Pressure.....	7-13
Start Low Oil Pressure .....	7-14
High Oil Separator Temp .....	7-14
Low Oil Separator Temp .....	7-14
Pre-Lube Pressure .....	7-15
Process Pressure .....	7-15
High Process Pressure .....	7-15
Low Process Pressure .....	7-16
Process Temperature	
High Process Temperature .....	7-16
Low Process Temperature .....	7-16
Remote Comm Time-Out.....	7-16
Low Run Pressure Ratio .....	7-17
SOI Oil Pressure	
SOI Low Oil Pressure .....	7-17
SOI Low Pressure Ratio.....	7-17
Starter.....	7-17
Suction Pressure	
Low Suction Pressure .....	7-17
Suction Superheat Temperature	
Low Suction Superheat .....	7-18
Suction Temperature	
Low Suction Temp.....	7-18
Volume Position Trip .....	7-18
<b>Section 8 • Timers</b>	
Overview .....	8-1
Timer Setpoints .....	8-1
<b>Section 9 • Compressor Scheduling</b>	
Overview .....	9-1
Scheduling Setpoint.....	9-1
<b>Section 10 • Compressor Sequencing</b>	
Overview .....	10-1
Compressor Sequencing Table .....	10-1
Status Symbols .....	10-3
Suction Pressure Control Setpoints .....	10-4
Pressure Setpoints .....	10-4
Capacity Load/Unload Timers .....	10-4
Process Control Setpoints - Temperature.....	10-5
Temperature Setpoints .....	10-5
Capacity Load/Unload Timers .....	10-5
Process Control Setpoints - Pressure .....	10-6
Pressure Setpoints .....	10-6
Capacity Load/Unload Timers .....	10-6
Discharge Pressure Control Setpoints.....	10-7
Pressure Setpoints .....	10-7
Capacity Load/Unload Timers .....	10-7

# Table of Contents

Section Title	Section Number
Devices List .....	10-8
Devices List Columns .....	10-8
View Detected Devices .....	10-9
Add Device .....	10-10
Delete Device.....	10-11
Test Connection.....	10-12
Sync Sequencing Parameters .....	10-13
Compressor Sequencing Events Log .....	10-14
Events List Columns .....	10-14
Configuration Overview .....	10-15
Setting Up The Slave Compressors For Sequencing .....	10-15
Setting Up The Master Compressor .....	10-17
<b>Section 11 • Condenser Control</b>	
Overview .....	11-1
Condenser Control Setpoint.....	11-1
Step Control.....	11-2
VFD Settings .....	11-3
<b>Section 12 • Service Options</b>	
Overview .....	12-1
Digital Outputs .....	12-1
Analog Outputs .....	12-5
<b>Section 13 • Instruments Calibration</b>	
Overview .....	13-1
Pressure Control Inputs.....	13-2
Motor Current.....	13-2
Remote Capacity .....	13-5
Analog Inputs .....	13-5
Analog Outputs .....	13-7
<b>Section 14 • Slide Calibration</b>	
Overview .....	14-1
Capacity Slide Valve Potentiometer.....	14-1
Volume Slide Valve Potentiometer .....	14-2
Slide Valve Operation.....	14-2
Calibrate Slide Valve Actuators.....	14-3
Command Shaft Rotation.....	14-6
Slide Valve Troubleshooting Guide .....	14-7
Slide Valve Actuator Troubleshooting Guide Blink Code .....	14-10
<b>Section 15 • Trend Chart</b>	
Overview .....	15-1
Chart Operation.....	15-1
Trend Data Storage .....	15-2
Setup .....	15-3
<b>Section 16 • Event List</b>	
Overview .....	16-1
Event list Columns.....	16-1

# Table of Contents

Section Title	Section Number
<b>Section 17 • Input / Output</b>	
Overview .....	17-1
QR Code.....	17-5
<b>Section 18 • Auxiliary Input / Output</b>	
Overview .....	18-1
Digital Inputs .....	18-1
Digital Outputs .....	18-2
Analog Inputs .....	18-2
Analog Outputs .....	18-4
Control .....	18-4
<b>Section 19 • Configuration</b>	
Overview .....	19-1
Compressor Identification.....	19-1
Units .....	19-1
Time & Date.....	19-2
Communications .....	19-2
Direct I/O.....	19-2
Run Permissive.....	19-2
Serial (Modbus RTU).....	19-2
Ethernet .....	19-3
VNC Account .....	19-3
Anti-Recycle.....	19-4
Restart On Power Failure .....	19-4
Compressor Sequencing .....	19-5
Language.....	19-5
Model & Refrigerant .....	19-5
Compressor Control.....	19-6
Optional Function Settings.....	19-6
Condenser Control .....	19-6
Touchscreen .....	19-7
Oil Pump.....	19-8
Oil Cooling.....	19-8
Motor Current Device .....	19-8
Alarms and Trips .....	19-8
Special Compressor Settings .....	19-8
Daily Auto Back-up Settings .....	19-9
Configurable Main Screen Settings.....	19-10
Digital Inputs .....	19-10
Analog Inputs .....	19-11
Analog Outputs .....	19-12
Digital Outputs .....	19-12
I/O Configuration.....	19-13
<b>Section 20 • Data Backup</b>	
Overview .....	20-1
Save / Load.....	20-1
Migrate.....	20-3
Factory Reset .....	20-3
Setpoints Report.....	20-4
Database Backup Procedure.....	20-5

# Table of Contents

---

Back-up Database of Original Flashcard.....	20-5
Replace Original Flashcard with New Flashcard.....	20-5
Restore Original Database to New Flashcard .....	20-5
Record Operating Setpoints and Configuration Information.....	20-7
Replace Flashcard.....	20-7
Re-enter Operating Setpoints and Configuration Information .....	20-7
<b>Section 21 • Maintenance</b>	
Overview .....	21-1
Chart .....	21-1
Notes .....	21-8
Log, Date, Time, User, Maintenance Performed, Run Hours .....	21-9
<b>Section 22 • User Access</b>	
Overview .....	22-1
Login .....	22-2
Manage Accounts .....	22-2
Screen Security Levels.....	22-3
<b>Section 23 • Help Screen</b>	
Overview .....	23-1
Screen Features .....	23-1
<b>Section 24 • Twin Screw Control</b>	
Overview .....	24-1
Setup - Configuration Screen .....	24-1
Operation .....	24-2
Slide Calibration - Capacity Slide Valve Potentiometer.....	24-2
Software Limits Setpoints .....	24-3
Twin Screw Oil Pressure .....	24-6
Oil Pressure Monitoring BEFORE Compressor Starts .....	24-6
Low Oil Pressure Safety Bypass.....	24-6
Oil Pressure Monitoring AFTER Compressor Starts .....	24-7
<b>Section 25 • Cool Compression Control</b>	
Overview .....	25-1
Setup .....	25-1
Control Functions .....	25-2
Operational Differences from Single Screw .....	25-4
<b>Section 26 • Remote Oil Cooler</b>	
Overview .....	26-1
Remote Oil Cooler Setpoint.....	26-1
Step Control.....	26-2
VFD Settings.....	26-2
<b>Section 27 • Parts</b>	
How to Read a Parts List and Illustration .....	27-1
Vilter™ Aftermarket Parts Contact Information .....	27-1
Vission 20/20 - Main Enclosure Electrical Components .....	27-3
Vission 20/20 - Door Interior Components .....	27-5
Vission 20/20 - SBC Assembly.....	27-7

# Table of Contents

---

<b>Appendix A • Vission 20/20 Troubleshooting Guide</b>	
Vission 20/20 Troubleshooting Guide.....	A-1
<b>Appendix B • Vission 20/20 Application Procedures</b>	
Vission 20/20 Application Procedures .....	B-1
<b>Appendix C • Remote Control and Monitoring of Vission 20/20 Panel</b>	
Remote Control and Monitoring of Vission 20/20 Panel.....	C-1
<b>Appendix D • Vission 20/20 Communication Table</b>	
Vission 20/20 Communication Table .....	D-1
<b>Appendix E • Abbreviations used on the Vission 20/20 panel screen</b>	
Abbreviations Table .....	E-1

# List of Tables and Figures

Table/Figure	Page Number
Table 3-1. Digital I/O .....	3-3
Table 3-2. Analog Inputs.....	3-5
Table 3-3. Analog Outputs.....	3-7
Table 3-4. Analog Input Jumper Tables.....	3-12
Table 6-1. Compressor Size and Liquid Injection Outlet Port Direction.....	6-19
Table 6-2. Step VI Digital Outputs depending on Volume Ratio.....	6-22
Table 10-1. Status Symbols .....	10-3
Table 14-1. Command Shaft Rotation Required By Actuator .....	14-6
Table 14-2. Slide Valve Troubleshooting Guide .....	14-7
Table 14-3. LED Blink Codes and Troubleshooting Guide.....	14-10
Table 22-1. Security Access Levels .....	22-3
Figure 1-1. Operational Flow Charts .....	1-1
Figure 2-1. Vission 20/20 with Individual Transformer .....	2-1
Figure 2-2. EMI and Vission 20/20 .....	2-1
Figure 2-3. Ground Wiring .....	2-2
Figure 2-4. Mixed Voltage Wiring.....	2-2
Figure 2-5. Correct Transformer Wiring Method .....	2-3
Figure 2-6. Incorrect Transformer Wiring Method .....	2-3
Figure 3-1. Hardware Architecture Overview .....	3-1
Figure 3-2. Liquid Injection #1 logic.....	3-2
Figure 3-3. Liquid Injection #2 logic.....	3-4
Figure 3-4. Digital I/O Board Layout.....	3-8
Figure 3-5. Digital Output Board Layout.....	3-9
Figure 3-6. Digital Input Board Layout.....	3-10
Figure 3-7. Digital Input-Output Board Layout.....	3-11
Figure 3-8. Analog Input Board Layout .....	3-12
Figure 3-9. Analog Output Board Layout .....	3-15
Figure 4-1. Main Screen.....	4-1
Figure 4-2. Top Status Bar .....	4-2
Figure 4-3. Parameter Bar .....	4-3
Figure 4-4. Unit Start Pop-Up Window .....	4-4
Figure 4-5. Bottom Status Bar .....	4-5
Figure 4-6. Splash Screen .....	4-6
Figure 4-7. Step VI Screen .....	4-7
Figure 4-8. SOI Solenoid Screen.....	4-8
Figure 4-9. Configurable Main Screen with Oil Pump and Oil Heater .....	4-9
Figure 4-10. Configurable Main Screen with SOI Solenoid and Oil Heater.....	4-10
Figure 4-11. Configurable Main Screen with SOI Solenoid and Separator Level .....	4-10
Figure 4-12. Configurable Main Screen with Step VI .....	4-11
Figure 4-13. Configurable Main Screen Default View .....	4-11
Figure 5-1. Menu Screen .....	5-1
Figure 5-2. Menu Screen with Remote Oil Cooler Enabled.....	5-2
Figure 6-1. Compressor Control Screen - Suction Pressure Control.....	6-1
Figure 6-2. Compressor Control Screen - Process Temperature Control .....	6-2
Figure 6-3. Compressor Control Screen - Process Pressure Control .....	6-3
Figure 6-4. Proportional Band & Setpoint .....	6-4
Figure 6-5. Compressor Control Screen - Discharge Pressure Control .....	6-4
Figure 6-6. Compressor Control Screen - VFD Settings Control .....	6-5
Figure 6-7. VFD One-Step Control Method .....	6-6
Figure 6-8. VFD Two-Step Control Method .....	6-6
Figure 6-9. Compressor Control Screen - Oil Restriction Solenoid .....	6-7
Figure 6-10. Compressor Control Screen - Rapid Cycling VFD Control .....	6-8
Figure 6-11. Compressor Control Screen - Pumpdown/Pulldown Control .....	6-10



# List of Tables and Figures

Table/Figure	Page Number
Figure 6-12. Compressor Control Screen - (Active Control Mode, Oil Control).....	6-12
Figure 6-13. Compressor Control Screen - Control Mode (SOI) .....	6-13
Figure 6-14. Compressor Control Screen - Control Mode (Oil Control for No Oil Pump).....	6-14
Figure 6-15. Compressor Control Screen - Stop Load, Force Unload and Slide Valve Control.....	6-15
Figure 6-16. Compressor Control Screen - Liquid Injection & Dual Liquid Injection Control .....	6-17
Figure 6-17. Port Inlet and Outlet Flow Directions .....	6-19
Figure 6-18. Compressor Control Screen - Fixed VI (Twin Screw).....	6-20
Figure 6-19. Compressor Control Screen - Continuous VI (Twin Screw).....	6-21
Figure 6-20. Compressor Control Screen - Step VI (Twin Screw).....	6-22
Figure 7-1. Typical Status Banner Message Display .....	7-1
Figure 7-2. Alarms and Trips Screen - Page 1 (Process Temperature).....	7-2
Figure 7-3. Alarms and Trips Screen - Page 2 (Process Pressure).....	7-3
Figure 7-4. Alarms and Trips Screen - Page 2.....	7-4
Figure 7-5. Alarms and Trips Screen - Page 2 Cool Compression.....	7-5
Figure 7-6. Alarms and Trips Screen - Page 3.....	7-6
Figure 7-7. Alarms and Trips Screen - Page 3 (SOI Solenoid) .....	7-7
Figure 7-8. Alarms and Trips Screen - Page 3 (No Oil Pump) .....	7-8
Figure 7-9. Alarms and Trips Screen - Page 3 (Cool Compression) .....	7-9
Figure 8-1. Timers Screen - Page 1.....	8-1
Figure 8-2. Timers Screen - Page 2 (Cool Compression) .....	8-3
Figure 8-3. Timers Screen - Page 2 (SOI Solenoid).....	8-4
Figure 8-4. Timers Screen - Page 2 (No Oil Pump).....	8-5
Figure 9-1. Compressor Scheduling Screen .....	9-1
Figure 10-1. Compressor Sequencing Screen - Page 1 .....	10-1
Figure 10-2. Compressor Sequencing Screen - Suction Pressure Control Setpoints (Page 2) .....	10-4
Figure 10-3. Compressor Sequencing Screen - Process Temperature Control Setpoints .....	10-5
Figure 10-4. Compressor Sequencing Screen - Process Pressure Control Setpoints .....	10-6
Figure 10-5. Compressor Sequencing Screen - Discharge Pressure Control Setpoints (Page 2).....	10-7
Figure 10-6. Compressor Sequencing Screen - Device List (Page 4).....	10-8
Figure 10-7. Compressor Sequencing Screen - View Detected Devices (Page 4).....	10-9
Figure 10-8. Compressor Sequencing Screen - Add Device (Page 4).....	10-10
Figure 10-9. Compressor Sequencing Screen - Delete Device (Page 4).....	10-11
Figure 10-10. Compressor Sequencing Screen – Test Connection.....	10-12
Figure 10-11. Compressor Sequencing Screen - Sync Sequencing Parameters (Page 5) .....	10-13
Figure 10-12. Compressor Sequencing Screen - Events Log (Page 5).....	10-14
Figure 10-13. Screen 1 - Compressor Setup for Compressor Sequencing (Slave) .....	10-15
Figure 10-14. Screen 2 - Placing Slave Compressors into Remote Mode .....	10-16
Figure 10-15. Compressor Setup for Compressor Sequencing Master.....	10-17
Figure 11-1. Condenser Control Screen - Page 1 .....	11-1
Figure 11-2. Condenser Control Screen - Page 2 .....	11-4
Figure 12-1. Service Options Screen - Digital Outputs (Page 1).....	12-1
Figure 12-2. Service Options Screen - Digital Outputs (Page 2).....	12-2
Figure 12-3. Service Options Screen - Digital Outputs (Page 3).....	12-3
Figure 12-4. Service Options Screen - Digital Outputs for Remote Oil Cooler (Page 3).....	12-4
Figure 12-5. Service Options Screen - Analog Outputs (Page 4) .....	12-5
Figure 13-1. Instruments Calibration Screen - Analog Inputs (Page 1).....	13-1
Figure 13-2. Instruments Calibration Screen - Analog Inputs (Page 2) .....	13-2
Figure 13-3. Instruments Calibration Screen - Process Temperature (Page 3) .....	13-3
Figure 13-4. Instruments Calibration Screen - Process Pressure (Page 3) .....	13-4
Figure 13-5. Instruments Calibration Screen - Motor Current (Page 3).....	13-4
Figure 13-6. Instruments Calibration Screen - Analog Inputs (Page 4).....	13-5
Figure 13-7. Instruments Calibration Screen - Analog Inputs (Page 5).....	13-6
Figure 13-8. Instruments Calibration Screen - Analog Outputs (Page 6).....	13-7

# List of Tables and Figures

Table/Figure	Page Number
Figure 14-1. Slide Calibration Screen.....	14-1
Figure 14-2. Actuator Assembly.....	14-3
Figure 14-3. Menu Screen and Slide Calibration Button (Vission 20/20).....	14-4
Figure 14-4. Photo-chopper.....	14-5
Figure 15-1. Trend Chart Screen.....	15-1
Figure 15-2. Trend Setup Screen.....	15-3
Figure 16-1. Event List Screen.....	16-1
Figure 17-1. Input/Output Screen - Page 1.....	17-1
Figure 17-2. Input/Output Screen - Page 1 (Process Pressure).....	17-2
Figure 17-3. Input/Output Screen - Page 2.....	17-2
Figure 17-4. Input/Output Screen - Page 3.....	17-3
Figure 17-5. Input/Output Screen - Page 4.....	17-3
Figure 17-6. Input/Output Screen - Page 4 (Remote Oil Cooler Enabled).....	17-4
Figure 17-7. Input/Output Screen - Freeze Data Page.....	17-4
Figure 17-8. QR Code.....	17-4
Figure 18-1. Auxiliary I/O Screen - Digital Inputs (Page 1).....	18-1
Figure 18-2. Auxiliary I/O Screen - Digital Outputs (Page 2).....	18-3
Figure 18-3. Auxiliary I/O Screen - Analog Inputs (Page 3).....	18-3
Figure 18-4. Auxiliary I/O Screen - Analog Inputs (Page 4).....	18-5
Figure 18-5. Auxiliary I/O Screen - Analog Inputs (Page 5).....	18-5
Figure 18-6. Auxiliary I/O Screen - Analog Outputs (Page 6).....	18-6
Figure 18-7. Auxiliary I/O Screen - Analog Outputs (Page 7).....	18-6
Figure 19-1. Configuration Screen - Initial Setup (Page 1).....	19-1
Figure 19-2. Configuration Screen - Compressor Control (Compressor Type – VSS) (Page 2).....	19-5
Figure 19-3. Configuration Screen - Compressor Control (Compressor Type – VRS) (Page 2).....	19-7
Figure 19-4. Configuration Screen - Compressor Control (Special Compressor Settings) (Page 2).....	19-9
Figure 19-5. Configuration Screen – Configurable Main Screen Settings (Page 3).....	19-10
Figure 19-6. Configuration Screen – Configurable Main Screen Settings (Page 4).....	19-11
Figure 19-7. Configuration Screen - Digital Auxiliaries (Page 5).....	19-12
Figure 19-8. Configuration Screen - Analog Auxiliaries (Page 6).....	19-13
Figure 19-9. Configuration Screen - Auxiliary Outputs (Page 7).....	19-14
Figure 19-10. Configuration Screen - I/O Configuration (Page 8).....	19-14
Figure 20-1. Data Backup Screen - Save/Load.....	20-1
Figure 20-2. Data Backup Screen - Migrate and Factory Reset.....	20-3
Figure 20-3. Data Backup Screen - Setpoints Report.....	20-4
Figure 20-4. Flashcard Replacement.....	20-8
Figure 21-1. Maintenance Screen - Chart.....	21-1
Figure 21-2. Maintenance Screen - Chart for Heat Pump.....	21-2
Figure 21-3. Maintenance Screen - Notes Icon.....	21-3
Figure 21-4. Maintenance Screen - Maintenance Due Soon.....	21-4
Figure 21-5. Maintenance Screen - Maintenance Overdue.....	21-5
Figure 21-6. Maintenance Screen - Confirmation for Maintenance Sign-Off.....	21-6
Figure 21-7. Maintenance Screen - Maintenance Sign-Off.....	21-7
Figure 21-8. Maintenance Screen - Notes.....	21-8
Figure 21-9. Maintenance Screen - Log.....	21-9
Figure 22-1. User Access Screen - Login.....	22-1
Figure 22-2. User Access Screen - Manage Accounts.....	22-2
Figure 23-1. Help Screen - Manual.....	23-1
Figure 23-2. Help Screen - USB.....	23-2
Figure 23-3. Version Pop-Up Screen.....	23-2
Figure 24-1. Configuration Screen - Twin Screw Option.....	24-1

# List of Tables and Figures

---

Figure 24-2. Slide Calibration - Fixed VI .....	24-2
Figure 24-3. Slide Calibration - Continuous VI.....	24-3
Figure 24-4. Slide Calibration - Step VI.....	24-4
Figure 24-5. Slide Calibration - Twin Screw Bump Pop-up Window .....	24-5
Figure 24-6. Prelube Oil Pressure and Run Oil Pressure Settings.....	24-6
Figure 24-7. Timers Menu - Twin Screw Control.....	24-7
Figure 25-1. Configuration Screen.....	25-1
Figure 25-2. Compressor Control Screen - Cool Compression Control (Page 2) .....	25-2
Figure 26-1. Remote Oil Cooler Screen (Page 1) .....	26-1
Figure 26-2. Remote Oil Cooler VFD Screen (Page 2) .....	26-3
Figure 27-1. Vission 20/20 - Main Enclosure Electrical Components .....	27-2
Figure 27-2. Vission 20/20 - Door Interior Components.....	27-4
Figure 27-3. Vission 20/20 - SBC Assembly .....	27-6

# How to Use This Manual

---

## NOTE

**Manual revision should match software version.**

This manual contains instructions for the Vision 20/20 Operation & Service Manual. It has been divided into 31 sections.

Section 1: Operational Flow Charts

Section 2: Installation Recommendations

Section 3: Hardware Architecture

Section 4: Main Screen

Section 5: Menu Screen

Section 6: Compressor Control

Section 7: Alarms & Trips

Section 8: Timers

Section 9: Compressor Scheduling

Section 10: Compressor Sequencing

Section 11: Condenser Control

Section 12: Service Options

Section 13: Instruments Calibration

Section 14: Slide Calibration

Section 15: Trend Chart

Section 16: Event List

Section 17: Input/Output

Section 18: Auxiliary Input/Output

Section 19: Configuration

Section 20: Data Backup

Section 21: Maintenance

Section 22: User Access

Section 23: Help Screen

Section 24: Twin Screw Control

Section 25: Cool Compression Control

Section 26: Remote Oil Cooler

Section 27: Parts

Appendix A: Vision 20/20 Troubleshooting Guide

Appendix B: Application Procedures

Appendix C: Remote Control

Appendix D: Vision 20/20 Communications

Appendix E: Abbreviations Used on the Vision 20/20 Panel Screen

It is highly recommended that the manual be reviewed prior to servicing the Vision 20/20 system parts.

Figures and tables are included to illustrate key concepts.

Safety precautions are shown throughout the manual. They are defined as the following:

**WARNING** - Warning statements are shown when there are hazardous situations, if not avoided, will result in serious injury or death.

**CAUTION** - Caution statements are shown when there are potentially hazardous situations, if not avoided, will result in damage to equipment.

**NOTE** - Notes are shown when there are additional information pertaining to the instructions explained.

**NOTICE** - Notices are shown when there are important information that can help avoid system failure.

## ADDITIONAL IMPORTANT NOTES

- Due to continuing changes and unit updates, always refer to the [www.Vilter.com](http://www.Vilter.com) to make sure you have the latest manual.
- Any suggestions for manual improvements can be made to Vilter™ Manufacturing at the contact information on page i.
- For additional video information pertaining to the Vision 20/20, refer to the Vilter™ video playlist at [www.YouTube.com/EmersonClimateTech](http://www.YouTube.com/EmersonClimateTech)

# Section 1 • Operational Flow Charts

## Requirements to Start Compressor

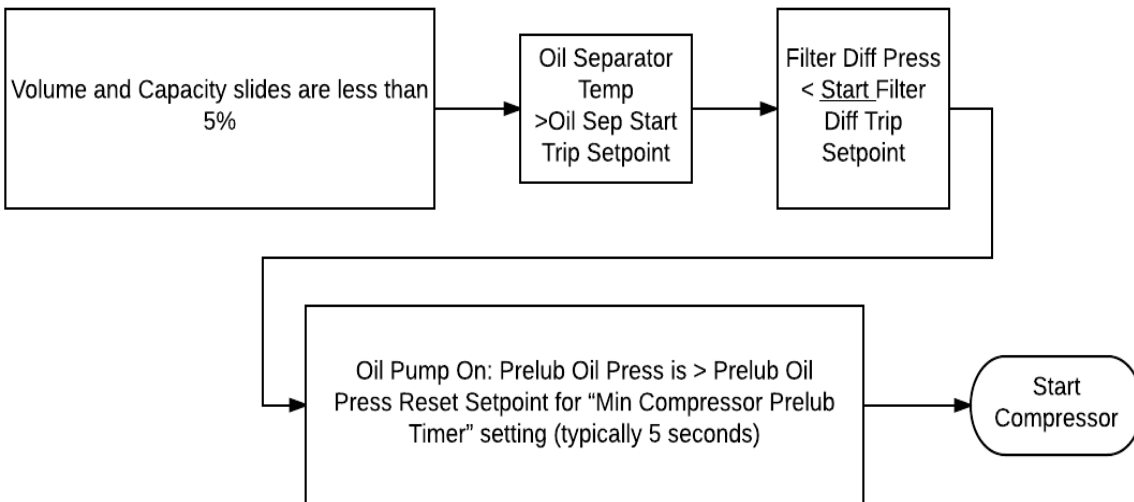

## Critical Compressor Run Logic at Compressor Start

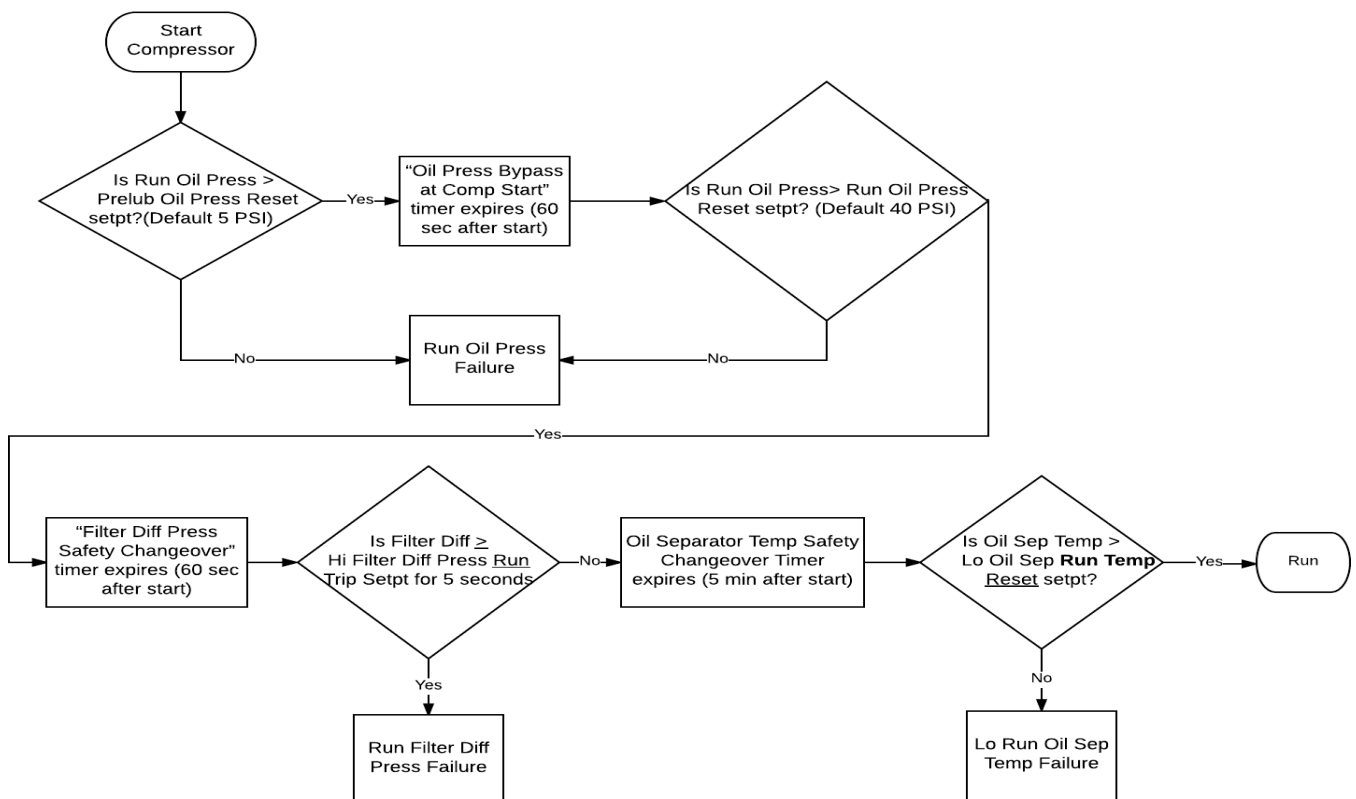
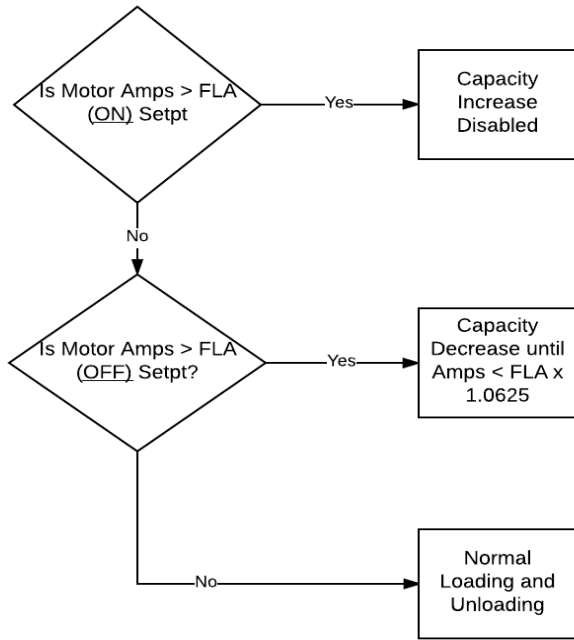

Figure 1-1. Operational Flow Charts (1 of 2)

# Section 1 • Operational Flow Charts

## Compressor Amperage Load Limiting



## High Discharge Pressure Load Limiting

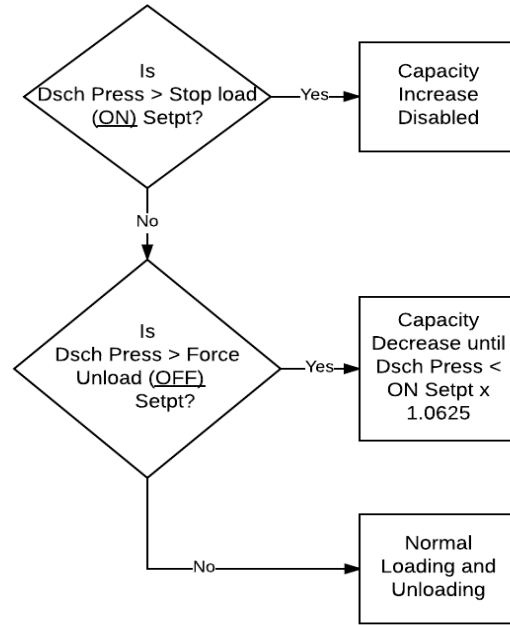

## Suction Pressure Override Load Limit During Temperature Control

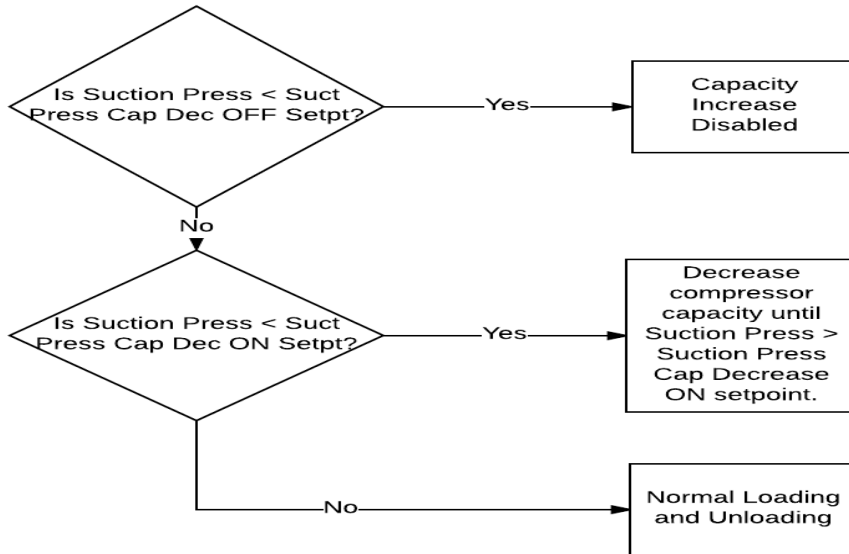

Figure 1-1. Operational Flow Charts (2 of 2)

## Section 2 • Installation Recommendations

### Proper Wiring Sizing

- Always size wire gauges as specified by the National Electrical Code (NEC) for electronic control devices.
- For improved noise immunity, install one size larger wire gauge than the NEC requirement to assure ample current-carrying capability.
- Never under size wire gauges.

### Voltage Source

- Transformers block a large percentage of

Electromagnetic Interference (EMI). The Vilter Vision 20/20™ should be isolated with its own control transformer for the most reliable operation, see Figure 2-1.

- Connecting the Vilter Vision 20/20™ to breaker panels and central control transformers exposes the Vision 20/20 to large amounts of EMI emitted from the other devices connected to the secondary terminals of the transformer. This practice should be avoided if possible, see Figure 2-2.

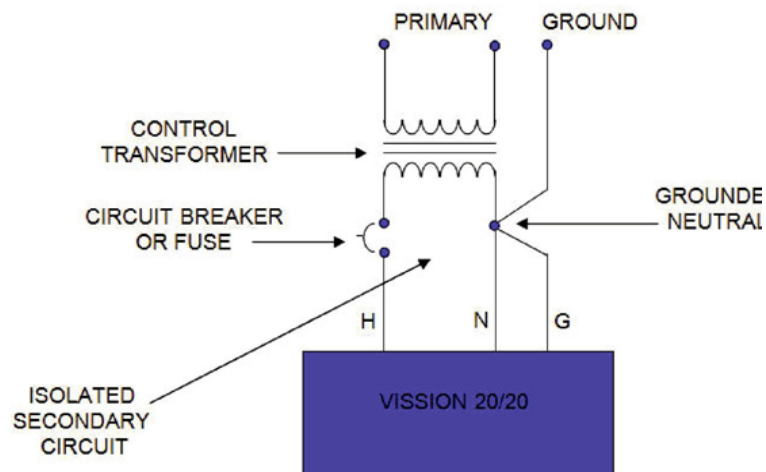

Figure 2-1. Vision 20/20 with Individual Transformer

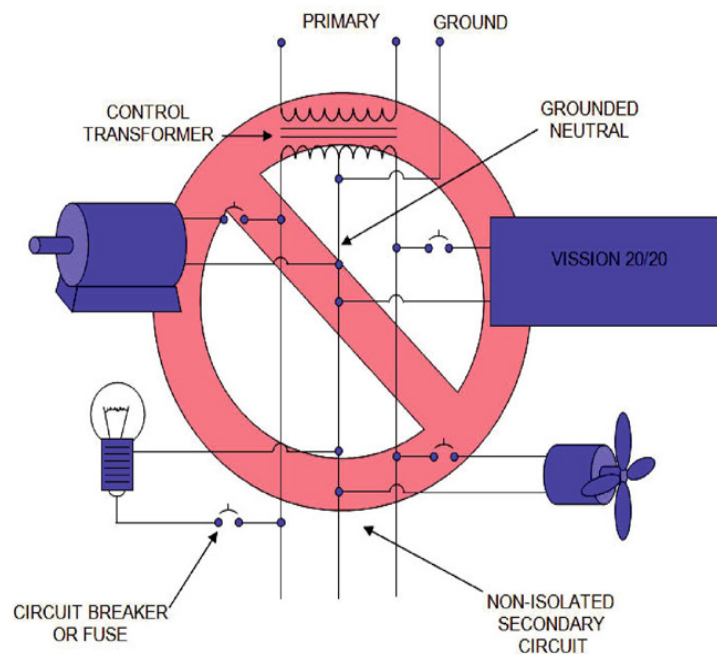

Figure 2-2. EMI and Vision 20/20

## Section 2 • Installation Recommendations

### Grounding

- Continuous grounds must be run from the utility ground to the Vision 20/20, see Figure 2-3. Grounding.
- Grounds must be copper or aluminum wire.
- Never use conduit grounds.

- Each voltage level must be run in separate conduit:

- 460 VAC
- 120 VAC
- DC Signals
- 230 VAC
- 24 VAC

- If your installation site has wireways or conduit trays, dividers must be installed between the different voltages.

### Mixing Voltages

- Separate different voltages from each other and separate AC from DC, see Figure 2-4.

### DC signals

- If your installation site has wire-ways or conduit trays, dividers must be installed between the different voltages.

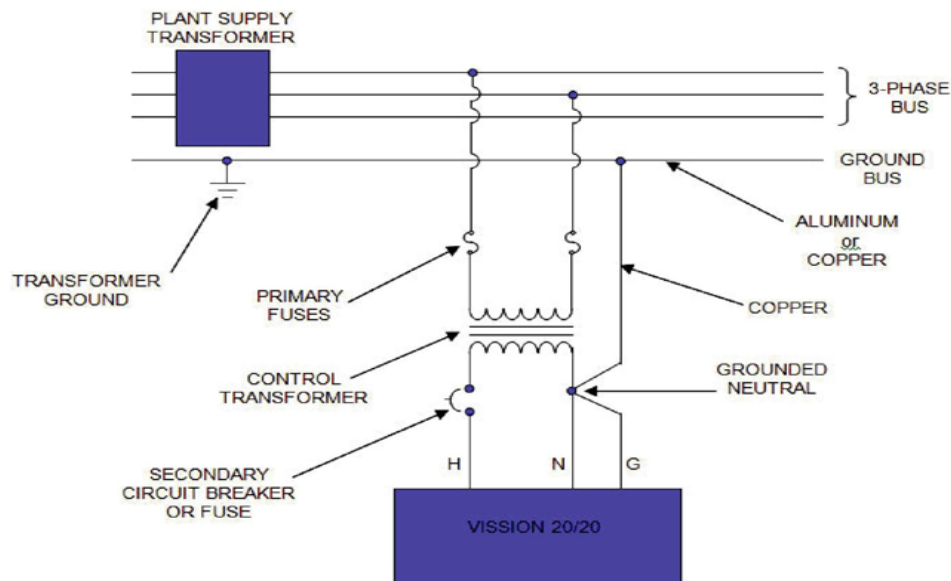

Figure 2-3. Ground Wiring

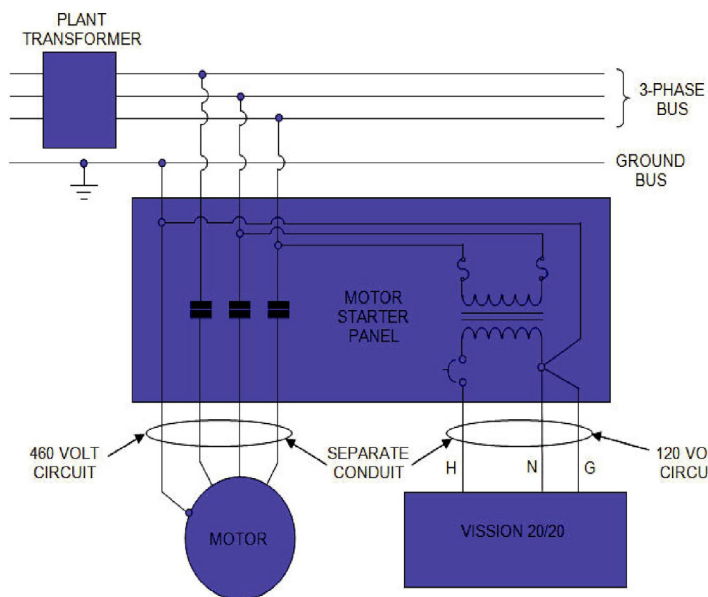

Figure 2-4. Mixed Voltage Wiring



## Section 2 • Installation Recommendations

### Wiring Methods

- Each Vision 20/20 panel should have its own individual control transformer, see Figure 2-5 and Figure 2-6.

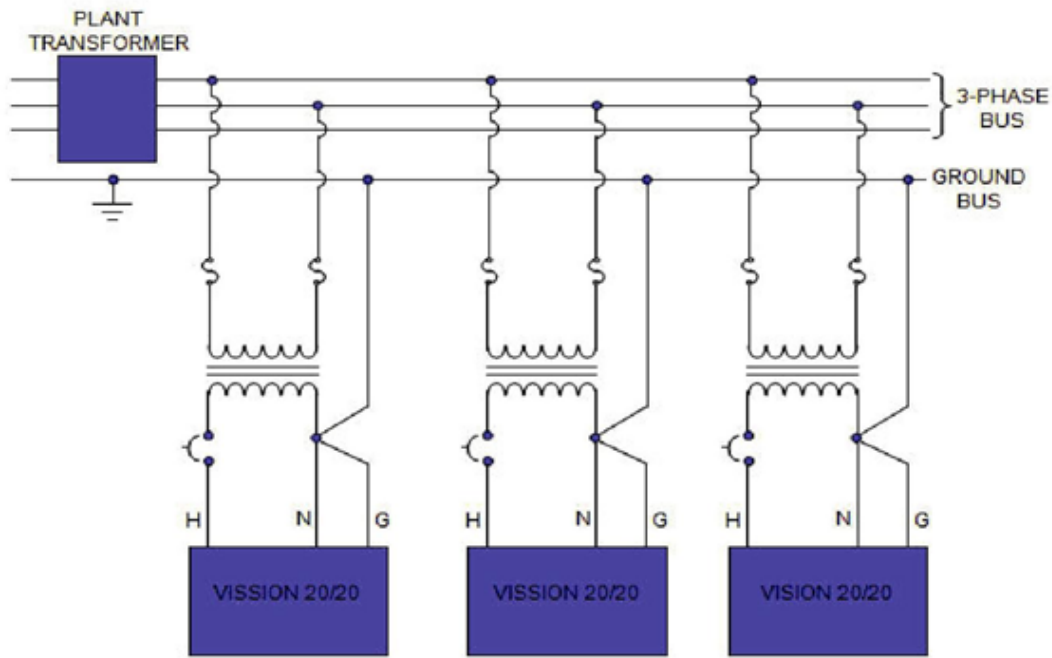

Figure 2-5. Correct Transformer Wiring Method

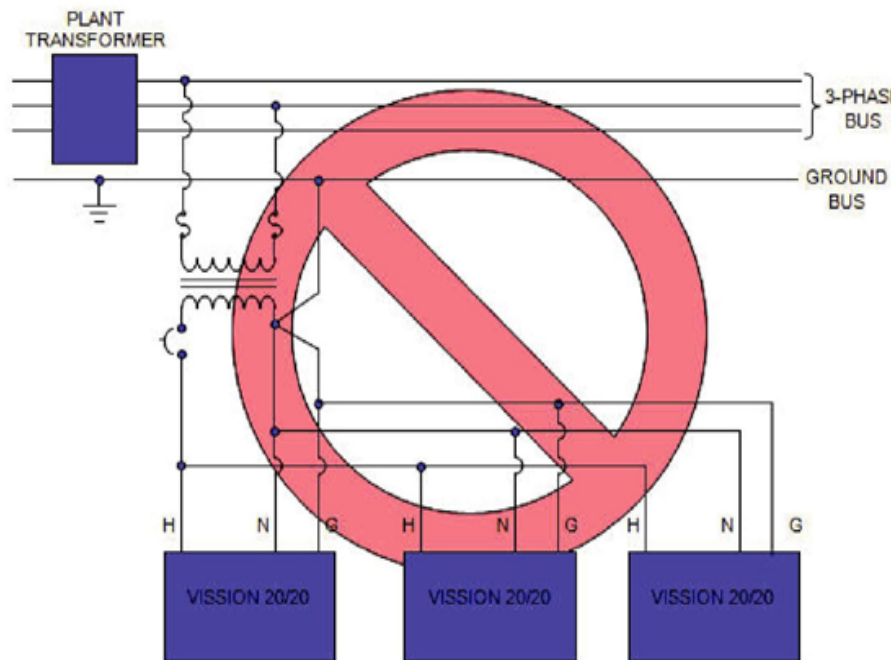

Figure 2-6. Incorrect Transformer Wiring Method

## Section 2 • Installation Recommendations

---

### Best Practices

- Do:
  - Keep AC wires away from circuit boards.
  - Always run conduit into the bottom or sides of an enclosure.
  - Use a water-tight conduit fitting to keep water from entering the enclosure, ... IF the conduit MUST be placed in the top of an enclosure.
  - The Vision 20/20 is supplied with pre-punched conduit holes. Use them!
- Don't:
  - Don't run wires through the Vision 20/20 enclosure that are not related to the compressor control.
  - Don't add relays, timers, transformers, etc. In the Vision 20/20 enclosure without first checking with Vilter™.
  - Don't run conduit into the top of an enclosure.
  - Don't run refrigerant tubing inside the enclosure.
  - Don't drill metal enclosures without taking proper precautions to protect circuit boards from damage.

### Transformer, Fusing and UPS Sizing

The following information can be used to help determine the power requirements for a 2020 panel. This can be helpful for sizing transformers or UPS devices that will power the Vision 2020 panel.

- The Vision 2020 panel contains two power supplies – Total power supply load = 90 watts.
  1. (1) 24VDC @ 2.2 A (53 watts)
  2. (1) dual output 12V @1 amp + 5V @ 4A = (35 watts)
- The DC loads that are attached to the power supplies breakdown like this;
  1. Each actuator = +24VDC @ 20mA ea (x2) = 40 mA
  2. Each press transducer = +24VDC @ 30 mA ea (x4) = 120 mA
  3. Each RTD (negligible) ( the hardware applies a 25 ma pulsed signal ... .not constant).  
For estimating purposes, assume:  
A total sum constant draw for total RTDs used 50 mA
  4. Each 4-20mA transmitter for an RTD = 10 mA
  5. Danfoss positioning valves:
    - ICAD 600 = 1.2 A
    - ICAD 900 = 2.0 A
  6. Howden 4-20mA LPI = 50 mA
- So for 120V fusing – consider 90 watts for the power supplies,  
PLUS add any additional 120V loads that are connected to the digital outputs + relays added to the panel.
  1. Each actuator motor = 0.6 amps AC load
  2. Each small solenoid = 50 watts ( estimate – read the nameplate for exact load rating)
  3. Large solenoids (water, hot gas) = 100 watts (estimate– read nameplate for exact load rating )
  4. Each small pilot relay = 25 watts ( estimate– read the nameplate for exact load rating)
  5. Add load values for panel heaters if used, and heat trace tape if used

## Section 3 • Hardware Architecture

### Overview

The Vision 20/20 control panel utilizes X-86 PC technology with a Linux operating system. For hardware architecture, see Figure 3-1.

The Vision 20/20 has the following attributes:

- Low power, Industrial rated X-86 CPU.
- 15" XGA, high resolution LCD display. (Outdoor viewable LCD optional).
- 8-wire touch screen operator interface.
- Flexible and expandable I/O.
- NEMA-4 enclosure (NEMA-4X optional).
- Industrial temperature range design.

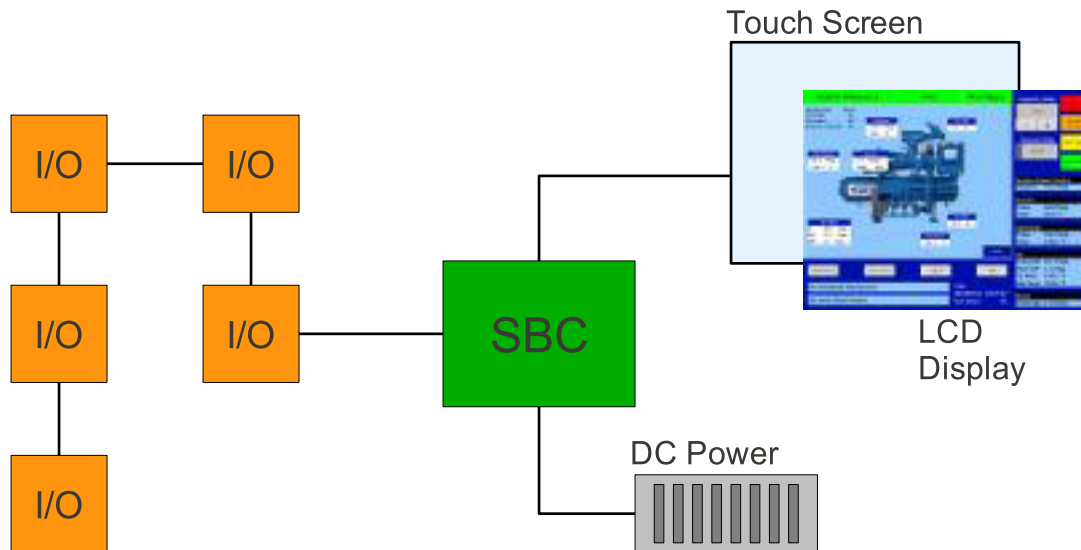

Figure 3-1. Hardware Architecture Overview

### Digital Input/Output (I/O)

Refer to Table 3-1.

#### Compressor Start Output:

- When the Vision 20/20 signals the compressor to start, this output is energized. When the Vision 20/20 signals the compressor to stop, this output is de-energized.

#### Oil Pump Start Output:

- When the Vision 20/20 signals the oil pump to start, this output is energized. When the Vision 20/20 signals the oil pump to stop, this output is de-energized.

#### Capacity Increase Output:

- This output is only active when the compressor is running. When the Vision 20/20 determines that the compressor should increase capacity by moving the slide valve to a higher percentage, this output is energized. Once the slide valve reaches 100%, this output will not energize.

#### Capacity Decrease Output:

- This output is only active when the compressor is running. When the Vision 20/20 determines that the compressor should decrease capacity by moving the slide valve to a lower percentage, this output is energized. Once the slide valve reaches 0%, this output will not energize.

#### Volume Increase Output:

- This output is only active when the compressor is running. When the Vision 20/20 determines that the compressor should increase Volume Index (VI) by moving the volume slide to a higher percentage, this output is energized. Once the volume slide reaches 100%, this output will not energize.

#### Volume Decrease Output:

- This output is only active when the compressor is running. When the Vision 20/20 determines that the compressor should decrease Volume Index (VI) by moving the volume slide to a lower percentage, this output is energized. Once the volume slide reaches 0%, this output will not energize.

## Section 3 • Hardware Architecture

output is energized. Once the volume slide reaches 0%, this output will not energize.

### Oil Sump Heater Output:

- This output is active and energized when the oil separator temperature is lower than the oil separator temperature setpoint. It is de-energized when the oil separator temperature is higher than the oil separator temperature setpoint.

### Trip Output:

- This output is energized when the system has no Trips. If a trip is issued, the output de-energizes and stays de-energized until the trip condition is cleared.

### Slide Valve Setpoint #1 Output (Economizer Port #1):

- Normally used for an economizer solenoid, but could be used for other devices. When the compressor slide valve percentage is equal to or greater than “slide valve set-point #1”, the output is energized. When the compressor slide valve percentage is less than “slide valve set-point #1”, the output is de-energized.

### Slide Valve Setpoint #2 Output (Hot Gas Bypass):

- Normally used for a hot gas solenoid, but could be used for other devices. When the compressor slide valve percentage is equal to or greater than “slide valve set-point #2”, the output is energized. When the compressor slide valve percentage is less than “slide valve set-point #2”, the output is de-energized.

### Alarm Output:

- This output is energized when the system has no alarms. If an alarm is issued, the output de-energizes and stays de-energized until the alarm condition is cleared.

### Economizer Port #2 Output:

- This output is energized when the compressor slide valve percentage is equal to or greater than slide valve set-point for economizer port 2. It is de-energized when the compressor slide valve percentage is less than slide valve set-point for economizer port 2.

### Liquid Injection #1 Output (see Figure 3-2):

- The function of this output will differ depending on what type liquid injection is selected. If the liquid injection solenoid only is chosen, then the output will energize when discharge temperature is above liquid injection setpoint #1 and the oil separator temperature is above the oil separator temperature override setpoint. The output is de-energized when any one of the above condition is not met.
- If the compressor has liquid injection with motorized valve oil cooling, then this output is energized when the compressor is running and the discharge temperature is above the oil separator temperature override setpoint and the oil separator temperature is above the override setpoint. The output is de-energized when the discharge temperature falls below the “on” setpoint minus the solenoid differential or when oil separator temperature is below the oil separator temperature override setpoint.

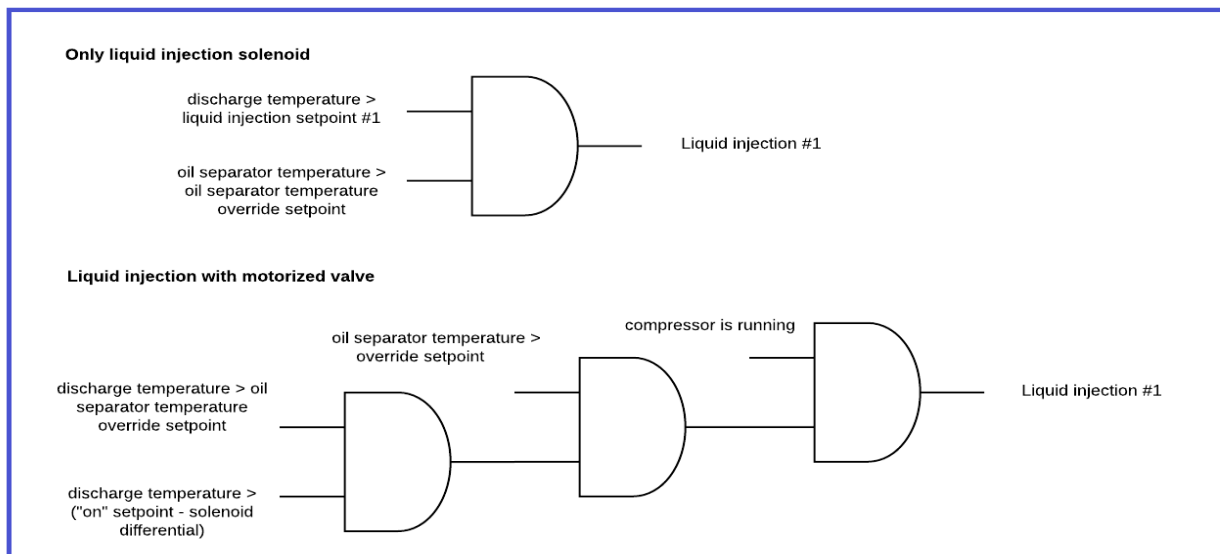

Figure 3-2. Liquid Injection #1 logic

## Section 3 • Hardware Architecture

Table 3-1. Digital I/O (1 of 2)

Board	I/O #	Description	Type
1	1	Compressor Start	OUTPUT
1	2	Oil Pump Start	OUTPUT
1	3	Capacity Increase	OUTPUT
1	4	Capacity Decrease	OUTPUT
1	5	Volume Increase	OUTPUT
1	6	Volume Decrease	OUTPUT
1	7	Oil Separator Heater	OUTPUT
1	8	Trip indicator (ON=Normal)	OUTPUT
2	9	Slide Valve Set point #1 (Economizer Port #1)	OUTPUT
2	10	Slide Valve Set point #2 (Hot Gas Bypass)	OUTPUT
2	11	Alarm (ON=Normal)	OUTPUT
2	12	Economizer Port #2	OUTPUT
2	13	Liquid Injection #1	OUTPUT
2	14	Liquid Injection #2	OUTPUT
2	15	Remote Enabled	OUTPUT
2	16	Shunt Trip	OUTPUT
3	17	Comp Motor Starter Auxiliary Contact	INPUT
3	18	High Level Shutdown	INPUT
3	19	Oil Level Float Switch #1	INPUT
3	20	Oil Level Float Switch #2	INPUT
3	21	Remote Setpoint #1/#2 Selection	INPUT
3	22	Remote Start/Stop	INPUT
3	23	Remote Capacity Increase	INPUT
3	24	Remote Capacity Decrease	INPUT
4	25	Condenser / Remote Oil Cooler Step #1	OUTPUT
4	26	Condenser / Remote Oil Cooler Step #2	OUTPUT
4	27	Condenser / Remote Oil Cooler Step #3	OUTPUT
4	28	Condenser / Remote Oil Cooler Step #4	OUTPUT
4	29	Auxiliary Input #1	INPUT
4	30	Auxiliary Input #2	INPUT
4	31	Auxiliary Input #3	INPUT
4	32	Auxiliary Input #4	INPUT

## Section 3 • Hardware Architecture

Liquid Injection #2 Output (see Figure 3-3):

- Used with the Dual Liquid Injection option, its availability depends on compressor type and model. The Liquid Injection # 2 digital output is controlled depending on Liquid Pressure and Slide % value.

Remote Enabled Output:

- This output is energized when the Vission 20/20 panel is enabled for remote control. If the compressor parameter does not satisfy start conditions or is placed into the manual stop position, this output is de-energized.

Shunt Trip:

- This output is designed to be connected to a master power breaker with a shunt trip input. If the Vission 20/20 detects the compressor motor is running when it's not suppose to be, then this output can be energized to trip the breaker supplying power to a starter.

Comp Motor Starter Auxiliary Contact:

- This input looks for a feedback signal from the compressor starter, confirming that the compressor starter is energized.

High Level Shutdown Input:

- This input must be energized in order for the compressor to operate. If de-energized, the compressor will shut down and issue a high level trip.

Oil Level Float Switch #1 Input:

- This input must be energized in order for the compressor to operate. If de-energized, the compressor will shut down and issue a oil level #1 trip.

Oil Level Float Switch #2 Input:

- This input must be energized in order for the compressor to operate. If de-energized, the compressor will shut down and issue a oil level #2 trip.

Remote Select #1/#2 Input:

- This input enables or disables remote I/O control. Energizing this input enables the Remote Capacity Increase and Remote Capacity Decrease inputs.

Remote Start/Stop Input:

- If the compressor is enabled for remote I/O control, this input is enabled. Energizing this input will issue a start for the compressor as long as it is available to run. De-energizing this input stops the compressor.

### NOTE

The scan interval on the remote increase and decrease inputs is approximately ONE SECOND. Please take that into account when developing a control scheme using the remote increase and remote decrease inputs for compressor control.

Remote Capacity Increase Input:

- If the compressor is enabled for remote I/O control, this input is enabled. Operational only when the compressor is running. Energizing this input will increase the slide valve position.
- The slide valve will continuously increase as long as this input is energized. The slide valve will not increase when this input is de-energized.

Remote Capacity Decrease Input:

- Operational only when the compressor is running. This input is enabled if the compressor is enabled for remote I/O control. Energizing this input will decrease the slide valve position. The slide valve will continuously decrease as long as this input is energized. The slide valve will not decrease when this input is de-energized.

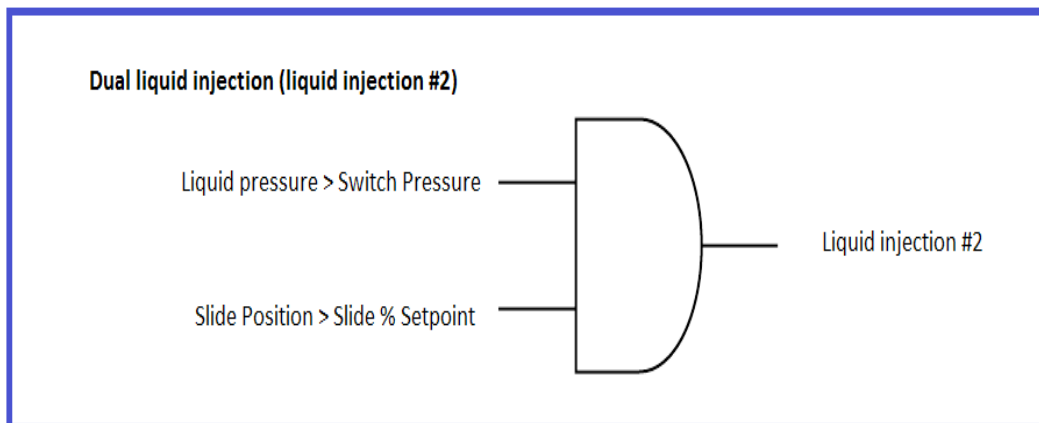

Figure 3-3. Liquid Injection #2 logic

## Section 3 • Hardware Architecture

Table 3-1. Digital I/O (2 of 2)

Board	I/O #	Description	Type
5	33	Auxiliary Output #1	OUTPUT
5	34	Auxiliary Output #2	OUTPUT
5	35	Auxiliary Output #3	OUTPUT
5	36	Auxiliary Output #4	OUTPUT
5	37	Auxiliary Input #5	INPUT
5	38	Auxiliary Input #6	INPUT
5	39	Auxiliary Input #7	INPUT
5	40	Auxiliary Input #8	INPUT

Table 3-2. Analog Inputs (1 of 2)

Board	I/O #	Description	Type
6	1	Motor Current	4-20 mA, 0-5A
6	2	Suction Pressure	0-5V, 1-5 V, 0-10V, 4-20 mA
6	3	Discharge Pressure	0-5V, 1-5 V, 0-10V, 4-20 mA
6	4	Oil Filter Inlet Pressure	0-5V, 1-5 V, 0-10V, 4-20 mA
6	5	Oil Manifold Pressure	0-5V, 1-5 V, 0-10V, 4-20 mA
6	6	Economizer Pressure	0-5V, 1-5 V, 0-10V, 4-20 mA
6	7	% Slide Valve Position	0-5V, 4-20 mA, Potentiometer
6	8	% Volume Position	0-5V, 4-20 mA, Potentiometer
7	9	Suction Temperature	4-20 mA, RTD, ICTD
7	10	Discharge Temperature	4-20 mA, RTD, ICTD
7	11	Oil Separator Temperature	4-20 mA, RTD, ICTD
7	12	Oil Manifold Temperature	4-20 mA, RTD, ICTD
7	13	Process Temperature	4-20 mA, RTD, ICTD
7	14	Chiller Inlet Temperature	4-20 mA, RTD, ICTD
7	15	Condenser Pressure	0-5V, 1-5 V, 0-10V, 4-20 mA, RTD, ICTD
7	16	Remote Caphold Setpoint	0-5V, 4-20 mA, RTD, ICTD
8	17	Auxiliary #1	0-5V, 1-5 V, 0-10V, 4-20 mA, RTD, ICTD
8	18	Auxiliary #2	0-5V, 1-5 V, 0-10V, 4-20 mA, RTD, ICTD
8	19	Auxiliary #3	0-5V, 1-5 V, 0-10V, 4-20 mA, RTD, ICTD
8	20	Auxiliary #4	0-5V, 1-5 V, 0-10V, 4-20 mA, RTD, ICTD
8	21	Auxiliary #5	0-5V, 1-5 V, 0-10V, 4-20 mA, RTD, ICTD
8	22	Auxiliary #6	0-5V, 1-5 V, 0-10V, 4-20 mA, RTD, ICTD
8	23	Auxiliary #7	0-5V, 1-5 V, 0-10V, 4-20 mA, RTD, ICTD
8	24	Auxiliary #8	0-5V, 1-5 V, 0-10V, 4-20 mA, RTD, ICTD
9	25	Auxiliary #9	0-5V, 1-5 V, 0-10V, 4-20 mA, RTD, ICTD
9	26	Auxiliary #10	0-5V, 1-5 V, 0-10V, 4-20 mA, RTD, ICTD
9	27	Auxiliary #11	0-5V, 1-5 V, 0-10V, 4-20 mA, RTD, ICTD

## Section 3 • Hardware Architecture

---

### Condenser / Remote Oil Cooler Step #1 Output:

- This output is enabled when condenser control or Remote Oil Cooler option is selected. A condenser / Remote Oil Cooler fan or pump will be turned on or off by this output.

### Condenser / Remote Oil Cooler Step #2 Output:

- This output is enabled when condenser control or Remote Oil Cooler option is selected. A condenser / Remote Oil Cooler fan or pump will be turned on or off by this output.

### Condenser / Remote Oil Cooler Step #3 Output:

- This output is enabled when condenser or Remote Oil Cooler control option is selected. A condenser / Remote Oil Cooler fan or pump will be turned on or off by this output.

### Condenser / Remote Oil Cooler Step #4 Output:

- This output is enabled when condenser or Remote Oil Cooler control option is selected. A condenser / Remote Oil Cooler fan or pump will be turned on or off by this output.

### Auxiliary Inputs #1 - #8:

- Optional inputs that can be configured as an alarm or trip. Typically connected to external switched devices.

### Auxiliary Outputs #1 - #4:

- Optional inputs that can be configured as an alarm or trip. Typically connected to external switched devices.

## Analog Inputs

Refer to Table 3-2.

### Motor Current:

- Default is a 0-5 Amp current transformer (CT). Current transformer ratio is set in the calibration screen.

### Suction Pressure:

- Default signal is 4-20mA. Suction pressure transducer range and calibration is set in the calibration screen.

### Discharge Pressure

- Default signal is 4-20mA. Discharge pressure transducer range and calibration are set in the calibration screen.

### Oil Filter Inlet Pressure:

- Default signal is 4-20mA. Oil filter pressure transducer range and calibration are set in the calibration screen.

### Oil Manifold Pressure:

- Default signal is 4-20mA. Oil manifold pressure transducer range and calibration are set in the calibration screen.

### Economizer Pressure:

- Default signal is 4-20mA. Economizer pressure transducer range and calibration are set in the calibration screen.

### Slide Valve Position:

- Reads the 0-5 volt signal back from the slide position motor actuator to indicate current slide valve position.

### Volume Position:

- Reads the 0-5 volt signal back from the slide volume motor actuator to indicate current volume position.

### Suction Temperature:

- Default signal is RTD. Suction temperature calibration is set in the calibration screen.

### Discharge Temperature:

- Default signal is RTD. Discharge temperature calibration is set in the calibration screen.

### Oil Separator Temperature:

- Default signal is RTD. Oil separator temperature calibration is set in the calibration screen.

### Oil Manifold Temperature:

- Default signal is RTD. Oil manifold temperature calibration is set in the calibration screen.

### Process Temperature:

- Default signal is 4-20mA. Process temperature calibration and range are set in the calibration screen.

### Chiller Inlet Temperature:

- Default signal is 4-20mA. Measures separator level. Chiller Inlet Temperature calibration and range are set in the calibration screen.

### Condenser Pressure:

- Default signal is 4-20mA. Condenser pressure transducer range and calibration are set in the calibration screen.

### Remote Caphold:

- Default signal is 4-20mA. Active in "Direct I/O" mode. Adjusts the capacity of the compressor from 0-100%, proportional to the 4-20mA signal.

### Auxiliary #1 - #16:

- Flexible analog inputs that can be configured to control, alarm or trip.



## Section 3 • Hardware Architecture

---

### Analog Outputs:

Refer to Table 3-3.

#### Compressor VFD:

- 4-20mA output to control compressor motor speed with a Variable Frequency Drive (VFD).

#### Condenser / Remote Oil Cooler VFD:

- 4-20mA output to control one condenser / remote oil cooler fan which is interleaved between the remaining condenser / remote oil cooler steps for smoother control.

#### % Slide Valve Position:

- 4-20mA signal that transmits the slide valve position for remote monitoring.

#### Motorized Valve (V+):

- For a cool compression compressor, this 4-20mA signal controls a motorized valve to regulate the liquid refrigerant level in the oil separator. For a liquid injection application on a standard single screw, this 4-20mA signal controls a motorized valve to regulate the liquid refrigerant injected into the compressor for oil cooling purposes.

#### Auxiliary Outputs #1 - #4:

- Optional outputs that can be configured in user defined manner.
- When Oil Flow Control option is selected from configuration screen, Auxiliary Output #1 which is 4-20mA signal is used to control the opening percentage of Danfoss valve.

## Section 3 • Hardware Architecture

Table 3-2. Analog Inputs (2 of 2)

Board	I/O #	Description	Type
9	28	Auxiliary #12	0-5V, 1-5 V, 0-10V, 4-20 mA, RTD, ICTD
9	29	Auxiliary #13	0-5V, 1-5 V, 0-10V, 4-20 mA, RTD, ICTD
9	30	Auxiliary #14	0-5V, 1-5 V, 0-10V, 4-20 mA, RTD, ICTD
9	31	Auxiliary #15	0-5V, 1-5 V, 0-10V, 4-20 mA, RTD, ICTD
9	32	Auxiliary #16	0-5V, 1-5 V, 0-10V, 4-20 mA, RTD, ICTD

Table 3-3. Analog Outputs

Board	I/O #	Description	Type
10	1	Compressor VFD	4-20 mA
10	2	Condenser / Remote Oil Cooler VFD	4-20 mA
10	3	% Slide Valve Position	4-20 mA
10	4	Motorized Valve (Cool Compression or Liquid Injection), V+	4-20 mA
10	5	Auxiliary Output #1	4-20 mA
10	6	Auxiliary Output #2	4-20 mA
10	7	Auxiliary Output #3	4-20 mA
10	8	Auxiliary Output #4	4-20 mA

### Digital & Analog I/O Boards Layout

It is important to install the boards in the proper layout. For the correct digital and analog input/output (I/O) board layout, see Figure 3-4.

#### Dipswitches

- Each board has a dipswitch which sets its communications address so that it can communicate with the CPU board. The dipswitch settings must be correct or the I/O will not function.

#### Jumpers

- Jumpers are required on the analog boards to configure them for the type of sensors used. The jumper table for the analog board shows the optional jumper configurations for sensors other than the default Vilter standard. If a different sensor is to be used, the jumpers on the analog board need to be changed. In addition, the configuration for this sensor must be changed in the Instrument Calibration screen. The following illustrations show the Vilter default configurations for the Vission 20/20.

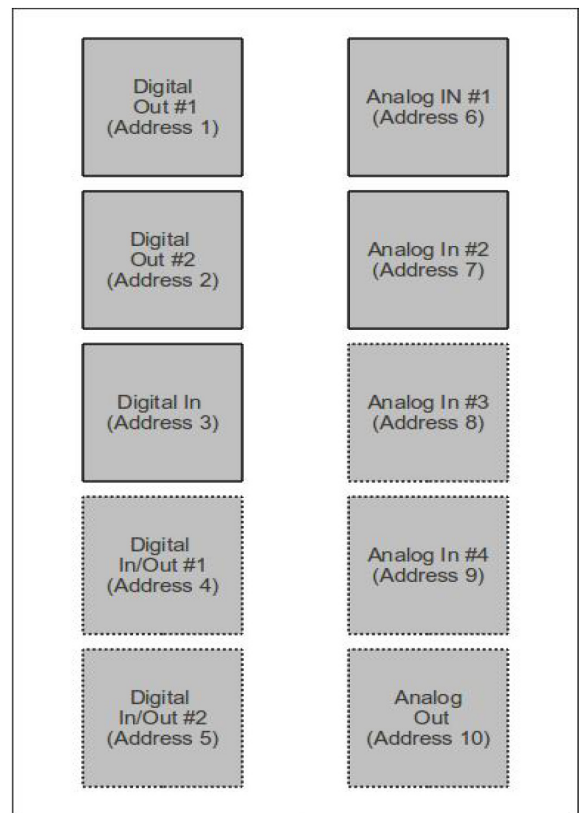

Figure 3-4. Digital I/O Board Layout

## Section 3 • Hardware Architecture

### Digital Output Boards

The digital output board converts signals generated by the Vission 20/20 program into 120VAC signals that can energize or signal other devices. All the signals are digital in that the only two states available are either on or off. See board layout, Figure 3-5.

#### Signal LEDs:

- Marked in the diagram below in Blue. These LEDs indicate when a 120VAC output is being produced.

#### Voltage LEDs:

- Marked in the diagram below in Orange. These LEDs indicate the correct voltage of both the 5V DC and 24V DC power sources.

#### Communication LEDs:

- Marked in the diagram below in Green. These LEDs show the active communications between the digital output board and the Vission 20/20 CPU board.

#### Address Dipswitches:

- Marked in the diagram below in Red. These dipswitches are used to assign each board its address position. The addresses are binary and therefore the address of a digital output board will either be address 1 (0001) or 2 (0010).

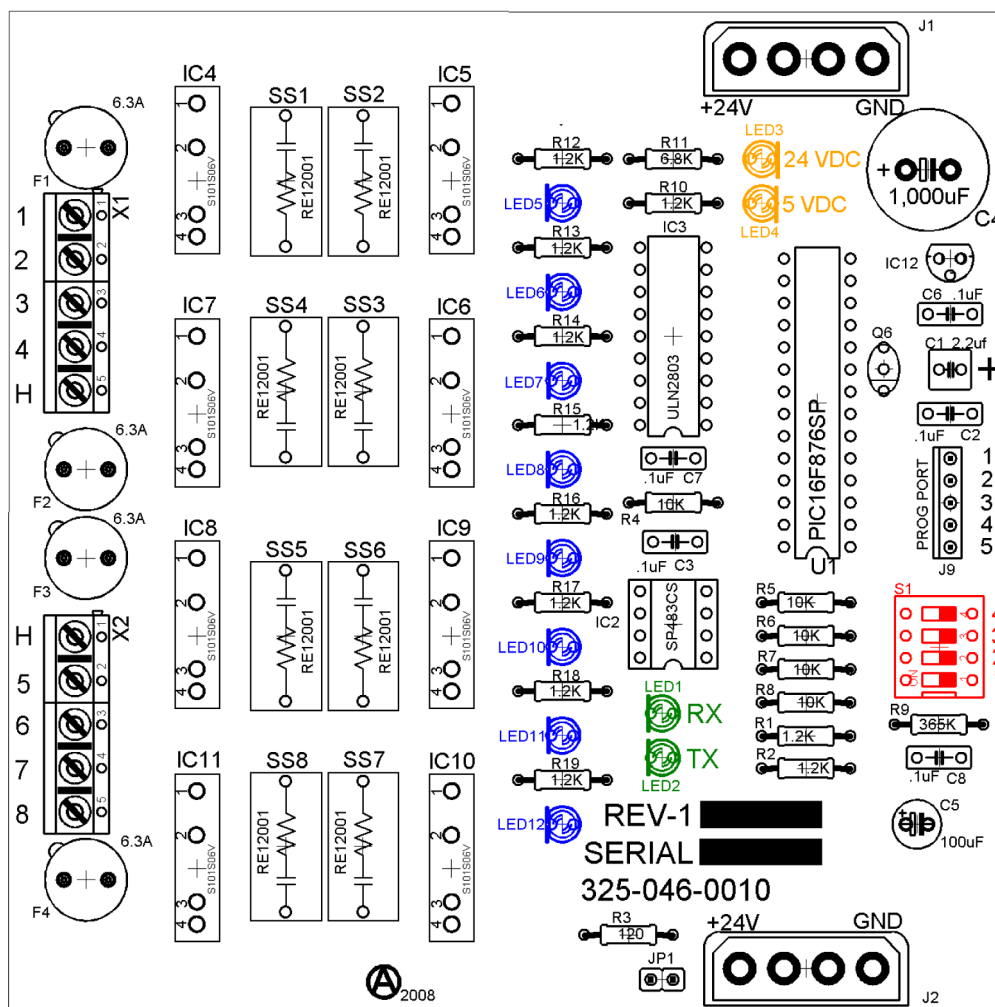

Figure 3-5. Digital Output Board Layout

## Section 3 • Hardware Architecture

### Digital Input Boards

The digital input board converts 120V DC signals from external devices to signals for the Vission 20/20 program. All the signals are digital in that the only two states available are either on or off. See board layout, Figure 3-6.

#### Signal LEDs:

- Marked in the diagram below in light Blue. These LEDs indicate when a 120VAC input is detected.

#### Voltage LEDs:

- Marked in the diagram below in Orange. These LEDs indicate the correct voltage of both the 5V DC and 24V DC power sources.

#### Communication LEDs:

- Marked in the diagram below in Green. These LEDs show the active communications between the digital output board and the Vission 20/20 CPU board.

#### Address Dipswitches:

- Marked in the diagram below in Red. These dipswitches are used to assign each board its address position. The addresses are binary and therefore the address of a digital input board can only be addressed as 3 (0011).

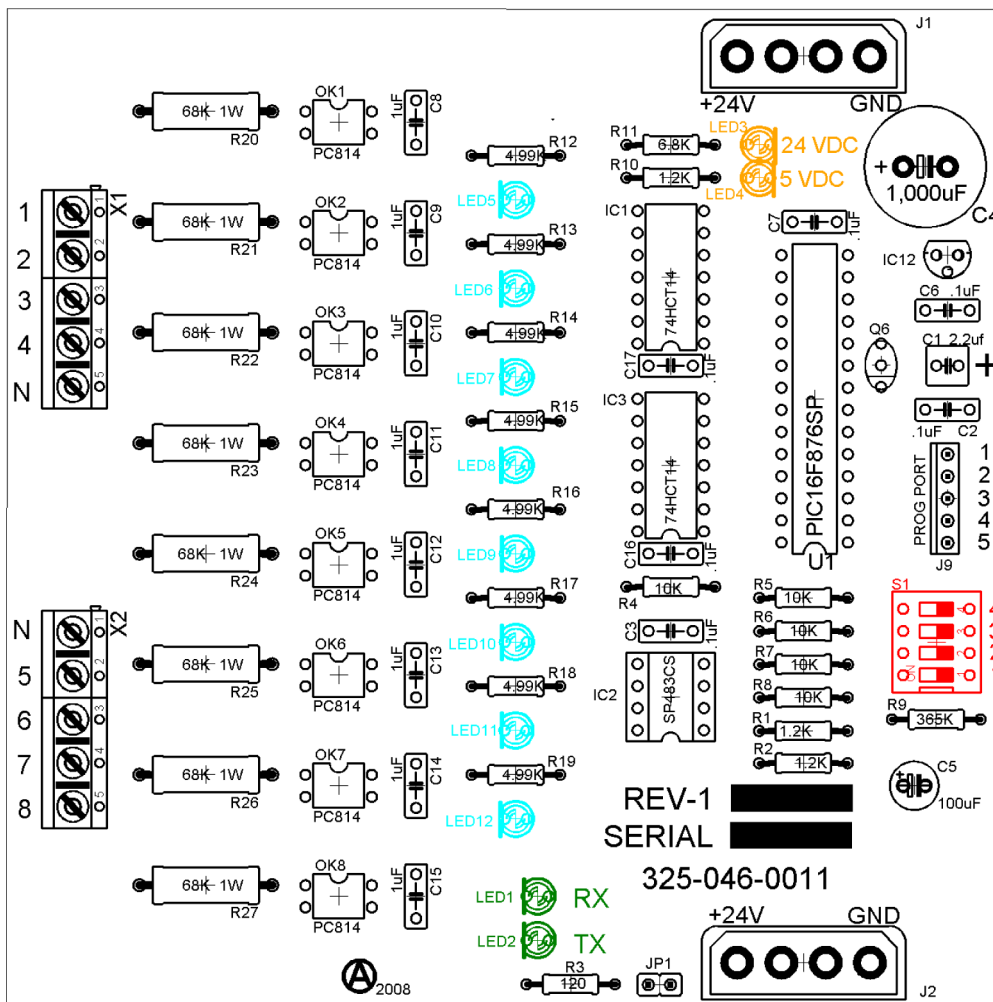

Figure 3-6. Digital Input Board Layout

## Section 3 • Hardware Architecture

### Digital In-Out Boards

The digital input - output board converts signals generated by the Vission 20/20 program into 120VAC signals as well as detect external 120VAC inputs to signal the Vission 20/20 program.

All the signals are digital in that the only two states available are either on or off. See board layout, Figure 3-7.

#### Signal LEDs:

- Marked in the diagram below in Blue or outputs and light blue for inputs. These LEDs indicate when a 120VAC output is being produced or a 120VAC signal is detected.

#### Voltage LEDs:

- Marked in the diagram below in Orange. These LEDs indicate the correct voltage of both the 5V DC and 24V DC power sources.

#### Communication LEDs:

- Marked in the diagram below in Green. These LEDs show the active communications between the digital output board and the Vission 20/20 CPU board.

#### Address Dipswitches:

- Marked in the diagram below in Red. These dipswitches are used to assign each board its address position. The addresses are binary and therefore the address of a digital output board will either be address 4 (0100) or 5 (0101).

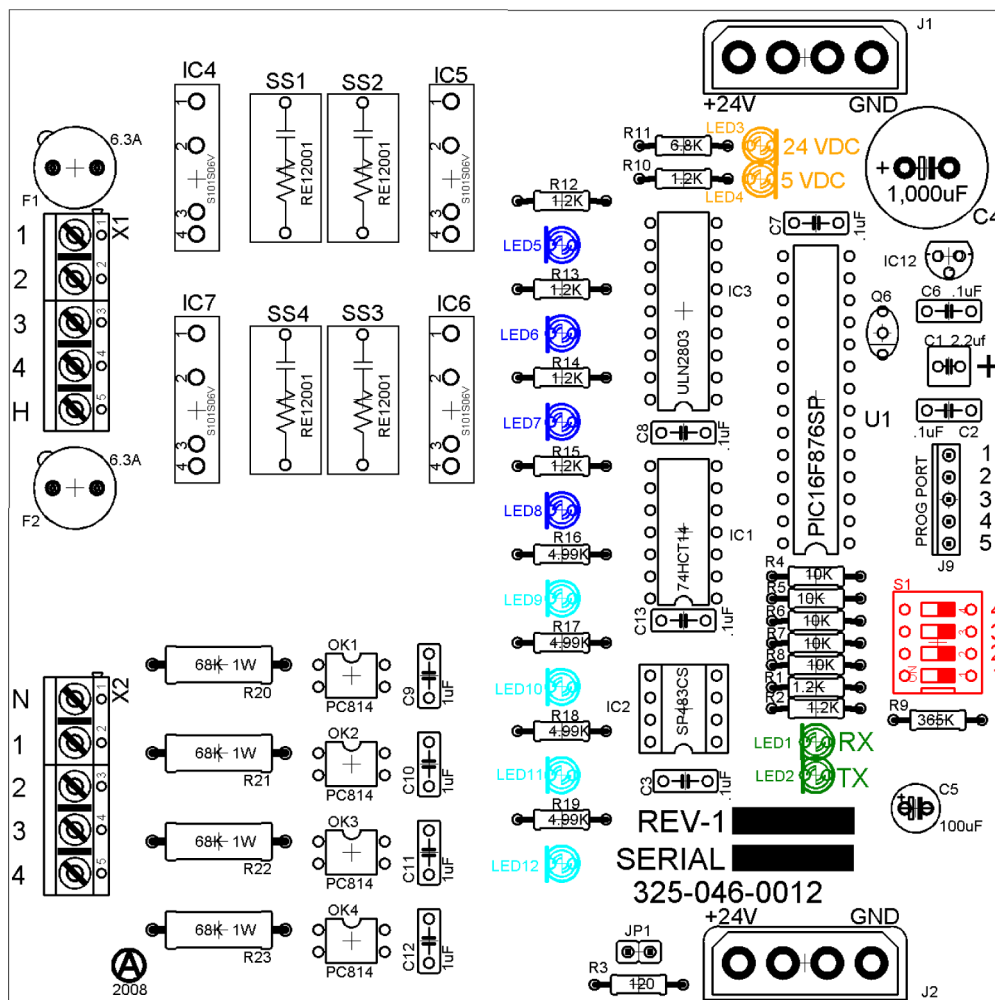

Figure 3-7. Digital Input-Output Board Layout



## Section 3 • Hardware Architecture

### Analog Input Jumper Tables

The following tables are used to configure each channel of the analog input board signal type and range desired by the operator, see Table 3-4.

**Table 3-4. Analog Input Jumper Tables**

CHANNEL 1	SIGNAL	JP-1	JP-2	JP-3	JP-27	JP-35
Analog Input 1-A*	0-5 AMP	OUT	OUT	OUT	OUT	IN
Analog input 1-B**	0-5 VOLT	OUT	OUT	OUT	OUT	OUT
	1-5 VOLT	OUT	OUT	OUT	OUT	OUT
	0-10 VOLT	OUT	OUT	IN	OUT	OUT
	4-20 mA	IN	OUT	OUT	OUT	OUT
	ICTD	OUT	IN	OUT	OUT	OUT
	RTD	OUT	OUT	OUT	IN	OUT

\*Use Analog Input 1-A when 0-5 AMP secondary current transformers are installed in the motor starter.

\*\*Use Analog Input 1-B when current transformers are installed in the motor starter.

CHANNEL 2	SIGNAL	JP-4	JP-5	JP-6	JP-28
Analog Input 2	0-5 VOLT	OUT	OUT	OUT	OUT
	1-5 VOLT	OUT	OUT	OUT	OUT
	0-10 VOLT	OUT	OUT	IN	OUT
	4-20 mA	IN	OUT	OUT	OUT
	ICTD	OUT	IN	OUT	OUT
	RTD	OUT	OUT	OUT	IN

CHANNEL 3	SIGNAL	JP-7	JP-8	JP-9	JP-29
Analog Input 3	0-5 VOLT	OUT	OUT	OUT	OUT
	1-5 VOLT	OUT	OUT	OUT	OUT
	0-10 VOLT	OUT	OUT	IN	OUT
	4-20 mA	IN	OUT	OUT	OUT
	ICTD	OUT	IN	OUT	OUT
	RTD	OUT	OUT	OUT	IN

CHANNEL 4	SIGNAL	JP-10	JP-11	JP-12	JP-30
Analog Input 4	0-5 VOLT	OUT	OUT	OUT	OUT
	1-5 VOLT	OUT	OUT	OUT	OUT
	0-10 VOLT	OUT	OUT	IN	OUT
	4-20 mA	IN	OUT	OUT	OUT
	ICTD	OUT	IN	OUT	OUT
	RTD	OUT	OUT	OUT	IN

## Section 3 • Hardware Architecture

Table 3-4. Analog Input Jumper Tables (Continued)

CHANNEL 5	SIGNAL	JP-13	JP-14	JP-15	JP-31
Analog Input 5	0-5 VOLT	OUT	OUT	OUT	OUT
	1-5 VOLT	OUT	OUT	OUT	OUT
	0-10 VOLT	OUT	OUT	IN	OUT
	4-20 mA	IN	OUT	OUT	OUT
	ICTD	OUT	IN	OUT	OUT
	RTD	OUT	OUT	OUT	IN

CHANNEL 6	SIGNAL	JP-16	JP-17	JP-18	JP-32
Analog Input 6	0-5 VOLT	OUT	OUT	OUT	OUT
	1-5 VOLT	OUT	OUT	OUT	OUT
	0-10 VOLT	OUT	OUT	IN	OUT
	4-20 mA	IN	OUT	OUT	OUT
	ICTD	OUT	IN	OUT	OUT
	RTD	OUT	OUT	OUT	IN

CHANNEL 7	SIGNAL	JP-19	JP-20	JP-21	JP-33	JP-25*
Analog input 7	0-5 VOLT	OUT	OUT	OUT	OUT	2
	1-5 VOLT	OUT	OUT	OUT	OUT	2
	0-10 VOLT	OUT	OUT	IN	OUT	2
	4-20 mA	IN	OUT	OUT	OUT	2
	ICTD	OUT	IN	OUT	OUT	2
	RTD	OUT	OUT	OUT	IN	2
	ACTUATOR	OUT	OUT	OUT	OUT	1
	POTENTIOMETER	OUT	OUT	OUT	OUT	3
	LPI	IN	OUT	OUT	OUT	1

\*JP-25

Position 1 = sends +24VDC (unregulated) to “supply” terminal (2.2A limit)

Position 2 = sends +24VDC (regulated) to “supply” terminal (25mA limit)

Position 3 = sends +5VDC (regulated) to “supply” terminal

CHANNEL 8	SIGNAL	JP-22	JP-23	JP-24	JP-34	JP-26
Analog Input 8	0-5 VOLT	OUT	OUT	OUT	OUT	2
	1-5 VOLT	OUT	OUT	OUT	OUT	2
	0-10 VOLT	OUT	OUT	IN	OUT	2
	4-20 mA	IN	OUT	OUT	OUT	2
	ICTD	OUT	IN	OUT	OUT	2
	RTD	OUT	OUT	OUT	IN	2
	ACTUATOR	OUT	OUT	OUT	OUT	1
	POTENTIOMETER	OUT	OUT	OUT	OUT	3



## Section 3 • Hardware Architecture

### Analog Output Boards

The Analog Output board converts signals from the Vission 20/20 program into a current ranging from 4mA to 20mA, see Figure 3-9.

Voltage LEDs:

- Marked in the diagram below in Orange. These LEDs indicate the correct voltage of both the 5V DC and 24V DC power sources.

Communication LEDs:

- Marked in the diagram below in Green. These LEDs show the active communications between the digital output board and the Vission 20/20 CPU board.

Address Dipswitches:

- Marked in the diagram below in Red. These dipswitches are used to assign each board its address position. The addresses are binary and therefore the address of a digital output board will only be addressed as 10 (1010).

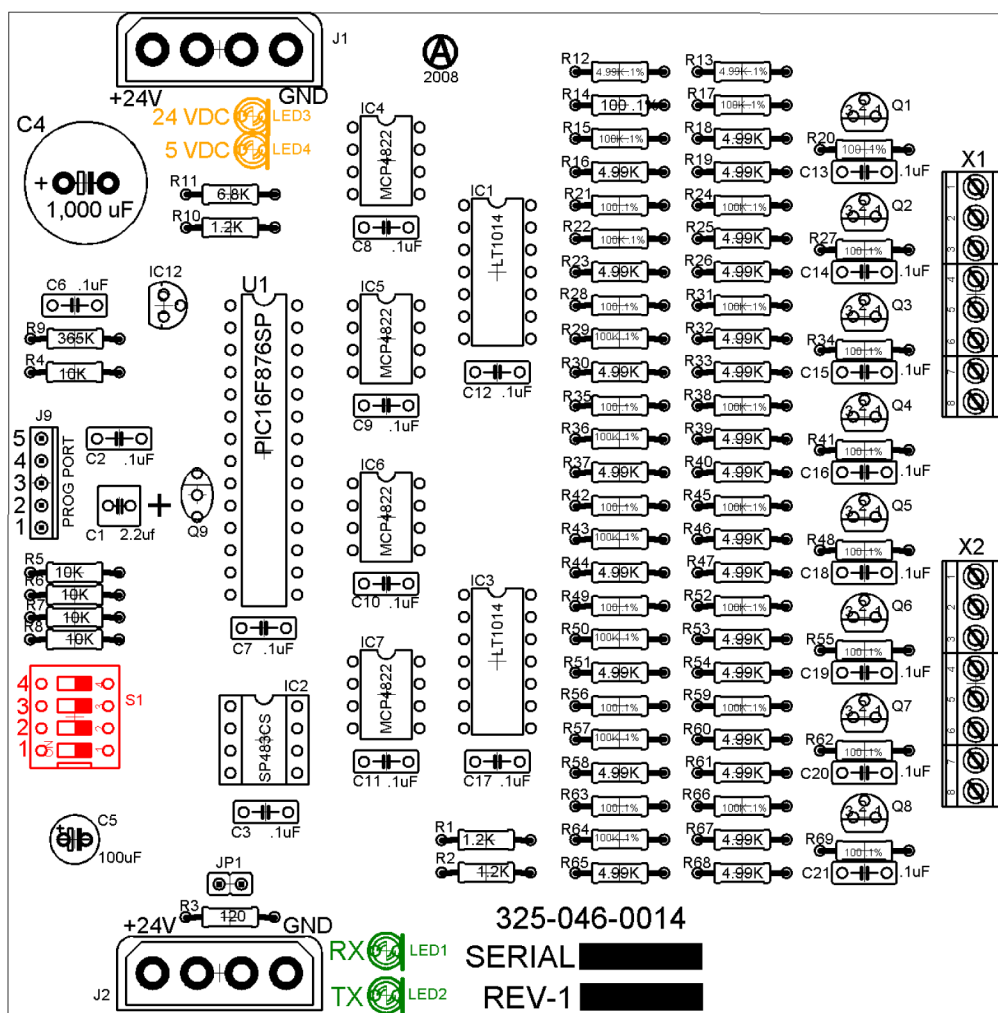

Figure 3-9. Analog Output Board Layout



## Section 4 • Main Screen

### Top Status Bar

The standard view of the status bar shows three pieces of information. From left to right, the bar shows the control method, the current run mode, and the difference between the desired control setpoint and the actual value of the processes control value, see Figure 4-2.

The status bar also has an alternate function where it displays to the user any information that requires the user's attention or intervention. It accomplishes this by changing the status bar's color and/or flashing additional information bars over the standard status bar view.

Standard Bar – blue:

- Indicates a condition where the compressor motor is not running.

Standard Bar – green:

- Informs the operator that the compressor motor is currently running.

Information Bars will flash their information over the top of the status bar. The operator will see the status bar and then one or more information bars in a repetitive sequence.

Information Bar – blue:

- Shows various operational modes that are different than normal running condition. An example of this would be a load limit condition. The compressor is not able to completely load due to some parameter like high motor current and therefore the operator is notified via this type of information bar.

Information bar – yellow

- This typically indicates an Alarm condition. Alarm conditions do not stop the compressor but are meant to alert the operator of conditions such that, if no corrective action is taken, can result in a compressor trip.

Information bar – red

- Informs the operator that the compressor's motor was stopped due the condition listed in the information bar. Compressor trips are designed to protect the equipment and any personnel operating the equipment.

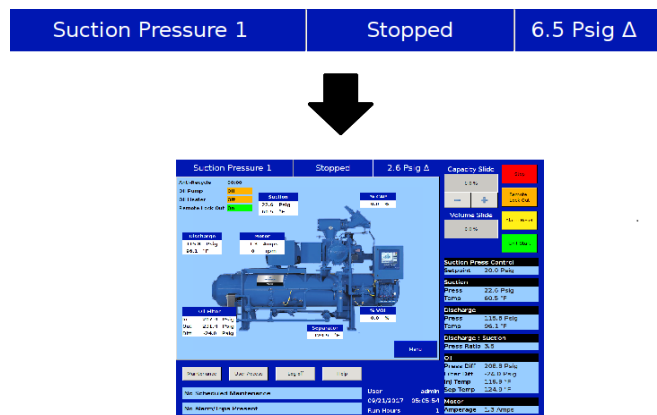

Figure 4-2. Top Status Bar

## Section 4 • Main Screen

### Parameter Bar

The main purpose of the Parameter Bar is to display the common operational parameters that the operator would be most concerned with. It also gives the operator access to critical buttons such as the “Stop” and “Start” buttons, see Figure 4-3.

#### Capacity Slide Indicator:

- Shows the position of the capacity slide from 0% to 100% via a horizontal gray bar. The buttons below the indicator are used in manual capacity control. The “-” button will decrease the capacity position and the “+” button will increase the position.

#### Volume Slide Indicator:

- Shows the position of the volume slide from 0% to 100% via a horizontal gray bar. In some cases, the increase and decrease buttons will appear below the volume indicator. The buttons only appear if the operator who is logged on has sufficient privileges. If available, the buttons work to increase and decrease the volume slide position in the same manner as the capacity slide.

#### Stop Button:

- When pressed, stops the compressor in all cases.

#### Remote Lock Out Button:

- When pressed, activates the remote lock out option. This is a safety feature that prevents any external devices from assuming control and starting the compressor. To release the remote lock out, the operator must press the “Unit Start” button and then the “Remote” button when the start dialog box appears.

#### Alarm Reset Button:

- When pressed, clears any current alarms, trips or status messages that may be displayed on the information bar. Note that, if the condition that created the alarm, trip or status message still exists, the message will reappear.

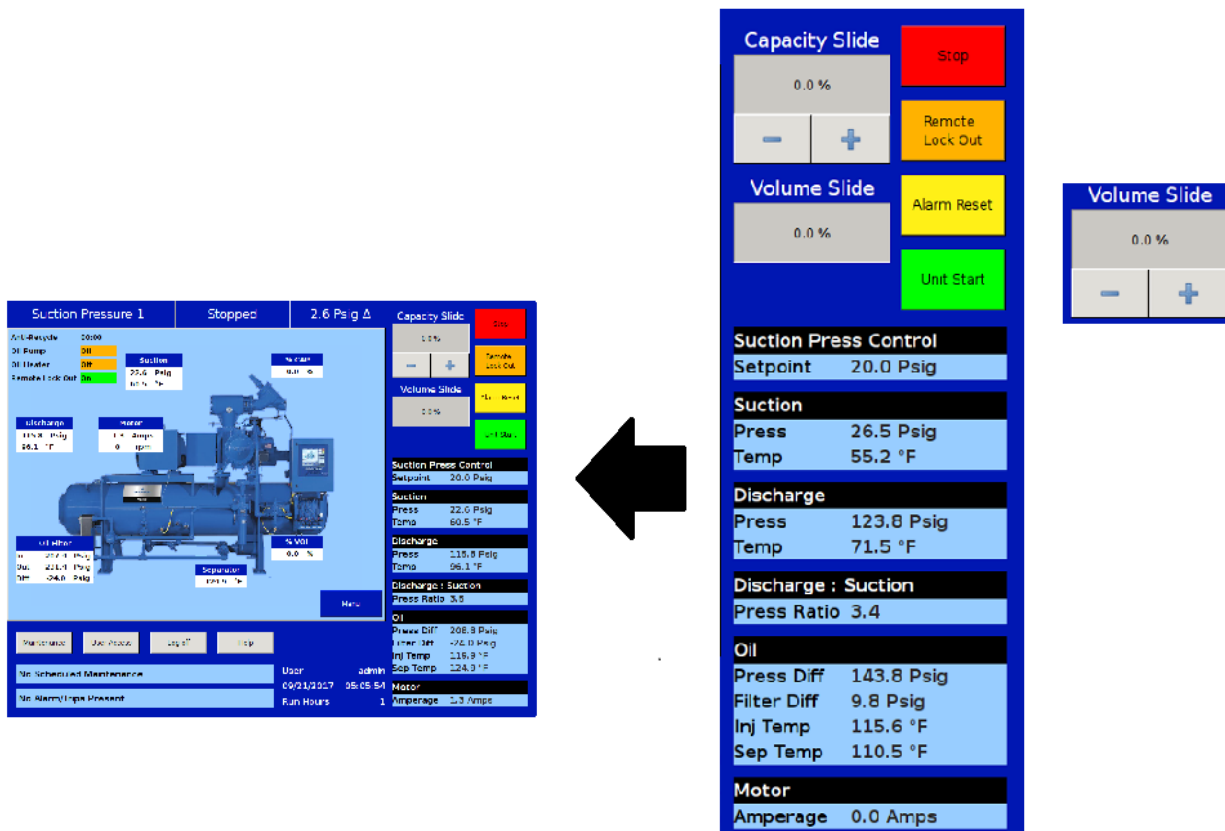

Figure 4-3. Parameter Bar

## Section 4 • Main Screen

### Parameter Bar (Continued)

Unit Start Button:

- When pressed, a start dialog box that gives the operator several run options will appear: Auto, Manual, Remote, Auto Seq or Cancel, see Figure 4-4.

Control Parameter Boxes:

- The parameter boxes provide updated data on several key control parameters.
  - The top box indicates the desired control setpoint that is set in the Compressor Control Screen. In the case that the Run mode is in remote capacity control, this box will show the desired capacity position.
  - The suction box shows the current suction

pressure and suction temperature.

- The discharge box shows the current discharge pressure and discharge temperature.
- The oil box shows the pressure differential which is calculated as oil filter out pressure minus suction pressure. Filter differential is calculated as oil filter in pressure minus oil filter out pressure. “Inj Temp” is the temperature of the oil at the oil injection port and “Sep Temp” is the temperature of the oil in the separator.
- The Discharge: Suction box shows the ratio of gage discharge pressure to gage suction pressure.
- The motor box shows the motor current.

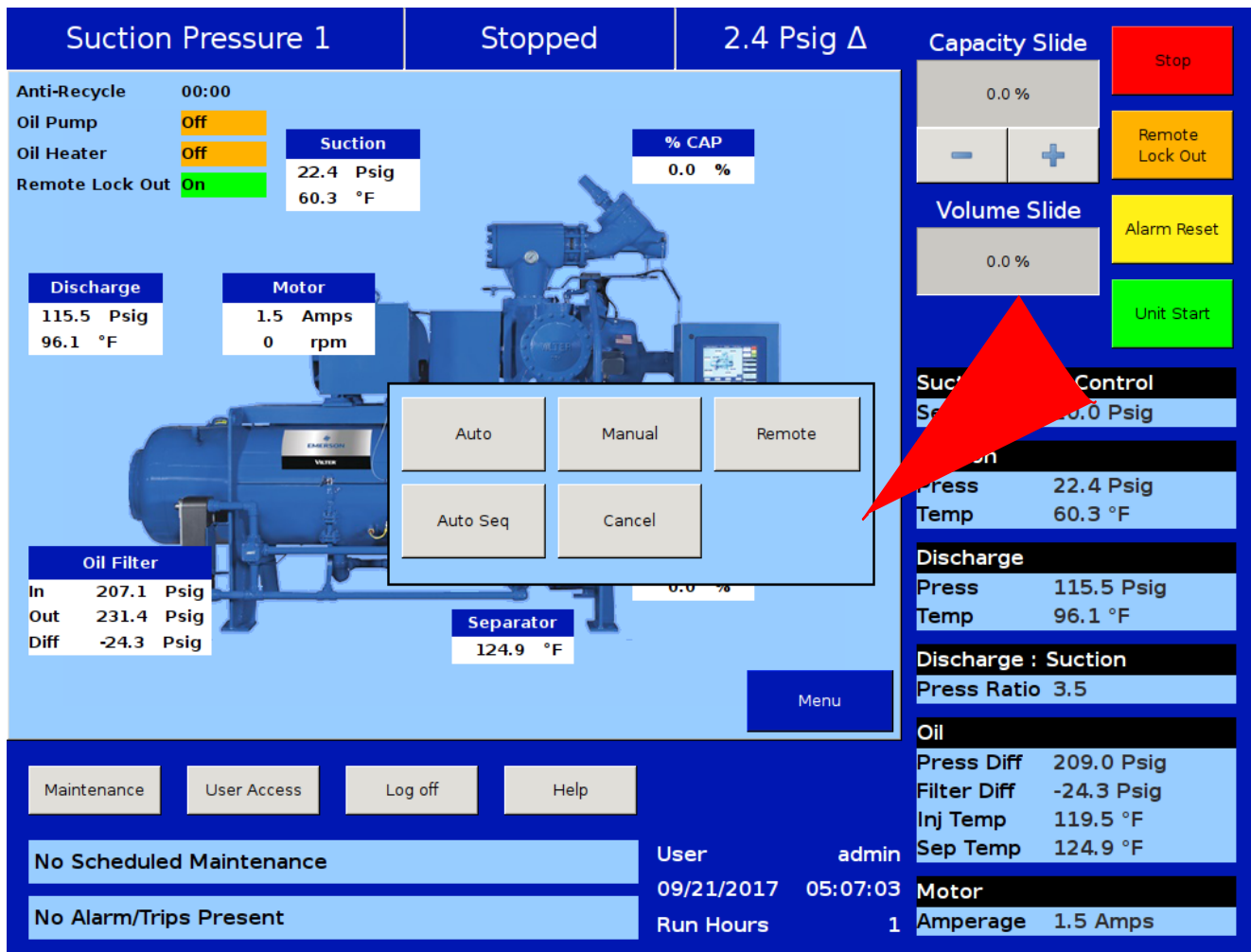

Figure 4-4. Unit Start Pop-Up Window

## Section 4 • Main Screen

### NOTE

The “Auto Seq” option in the “Unit Start” pop-up will only appear when sequencing compressors.

### Bottom Status Bar

The bottom status bar gives the operator easy access to some basic functions and information. The functions are available via the four buttons, see Figure 4-5.

Maintenance Button:

- Pressing the maintenance button will give the operator access to the maintenance charts and sign off tables.

User Access Button:

- This button takes the operator to the login screen to create additional users or log in.

Log off Button:

- Pressing the log off button logs off the current user if any are logged in.

Help Button:

- Pressing the help button takes the operator to the help screen where the operation and service manual can be read, and where there’s access to program information as well.

Status Bars

- The information available is provided by two status bars, one for maintenance activities and the other for any alarms or trips that might be active. To the right of the status bars there is a space to display the current user (if any are logged in), the date and time, and the total run hours of the compressor.

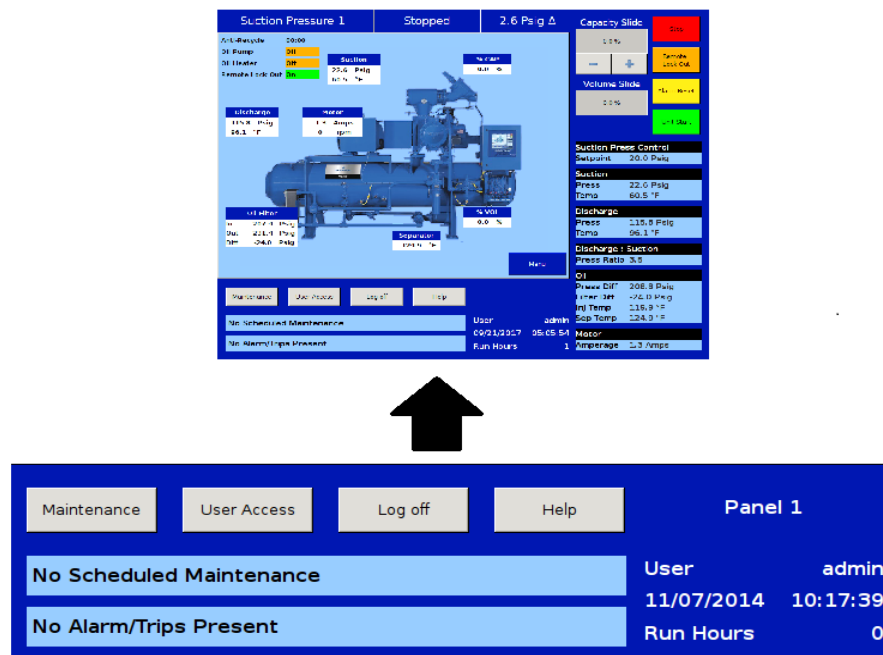

Figure 4-5. Bottom Status Bar

## Section 4 • Main Screen

### Splash Screen

The splash screen is the dynamic portion of the screen that will change as the operator navigates through the Vission 20/20 panel screen, see Figure 4-6. The main screen shows a graphic of a Vilter™ compressor with several data boxes spread across the screen. Also on the top left are several indicators.

#### Discharge:

- Displays the discharge pressure and temperature.

#### Oil Filter:

- Displays the oil filter inlet pressure, oil filter outlet pressure, and oil differential pressure across the oil filter.

#### Suction:

- Displays the suction pressure and temperature.

#### Motor:

- Displays the motor current. When the motor VFD is enabled, this box will also display the motor RPM.

#### Separator:

- Displays the temperature of the oil in the separator.

#### % Cap:

- Displays the position of the capacity slide from 0% to 100%.

#### Process:

- When the Process control is selected as the control mode, this box will appear and display either of the process temperature or process pressure depending on process control mode selection.

#### % Vol:

- Displays the position of the volume slide from 0% to 100% .

#### Anti-Recycle:

- Displays the anti-recycle time, if applicable.

#### Oil Pump:

- The oil pump on a Vilter™ compressor often cycles on and off depending on differential pressure. This indicator informs the operator when the oil pump is running.

#### Oil Heater:

- The oil heater often cycles on and off depending on the separator oil temperature. This indicator informs the operator when the oil heater is on.

#### Remote Lock Out:

- Displays the current status of the remote lock out. While on, no system controller can remotely assume control of the Vission 20/20 panel and start the compressor.

#### Menu Button:

- When pressed, navigates the operator to the menu screen.

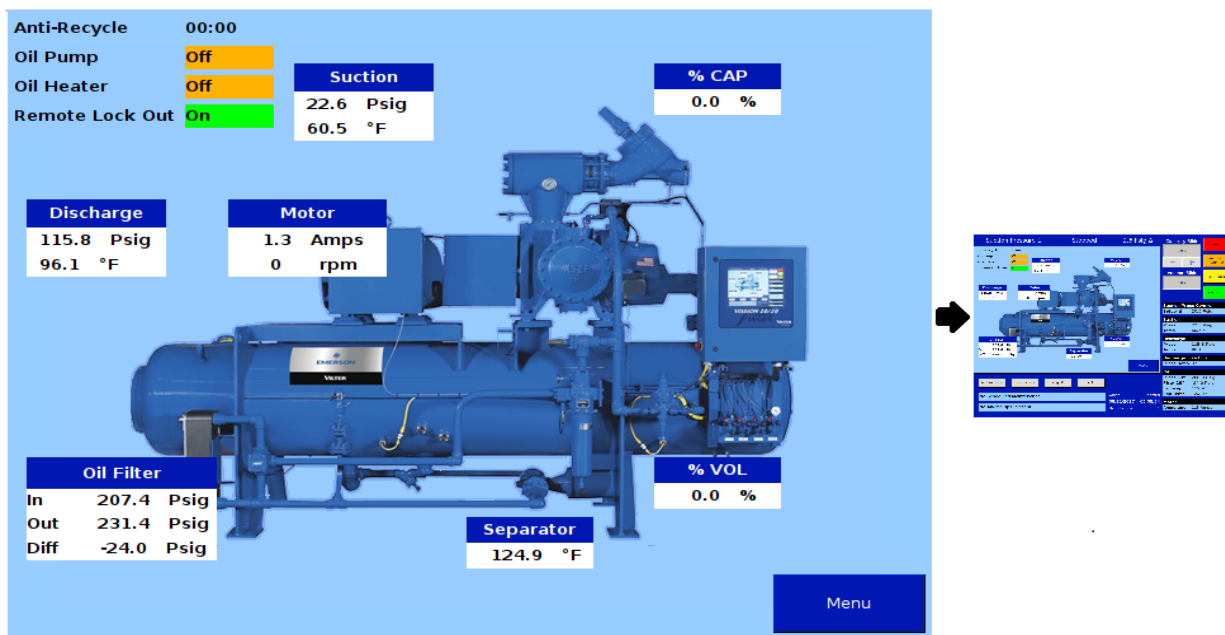

Figure 4-6. Splash Screen



## Section 4 • Main Screen

### Step VI Screen

This will be displayed only when the VI control method is set as Step VI.

Refer to Section 6, Compressor Control, for more on Step VI.

Low VI:

- Displays the current status of Low VI Digital Output
- This will be displayed only when the VI control method is set as Step VI.

High VI:

- Displays the current status of High VI Digital Output
- This will be displayed only when the VI control method is set as Step VI.

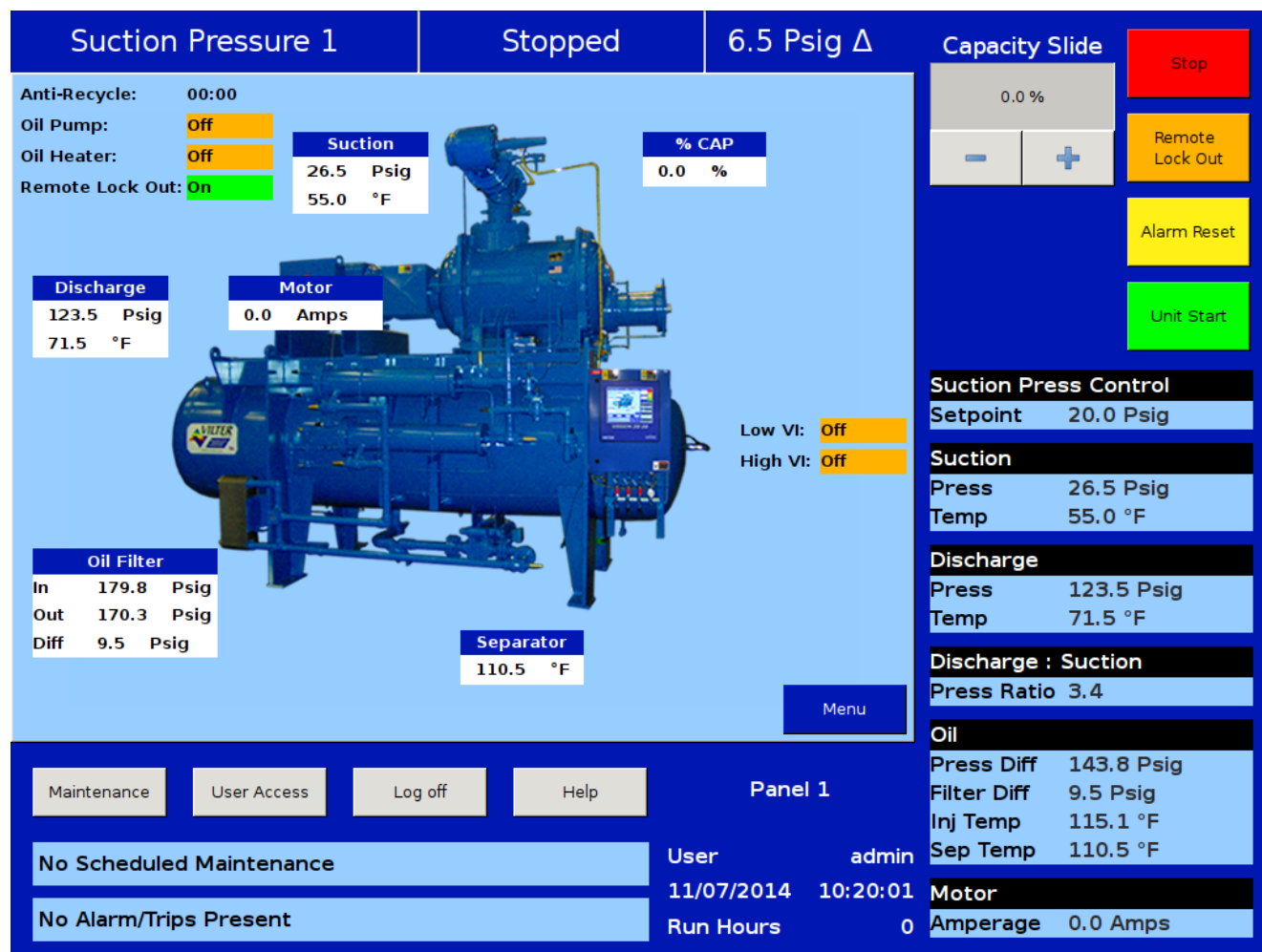

Figure 4-7. Step VI Screen



## Section 4 • Main Screen

### SOI Solenoid Screen

Refer to Section 6, Compressor Control, for more on SOI Solenoid.

SOI Solenoid:

- Displays the current status of SOI Solenoid Digital Output
- This will be displayed instead of Oil Pump when the SOI Solenoid Feature is enabled from Configuration Screen.

#### NOTE

The 'On' state for digital outputs on the main screen will be displayed with a Green Background while the 'Off' state for digital outputs will be displayed with an Orange Background

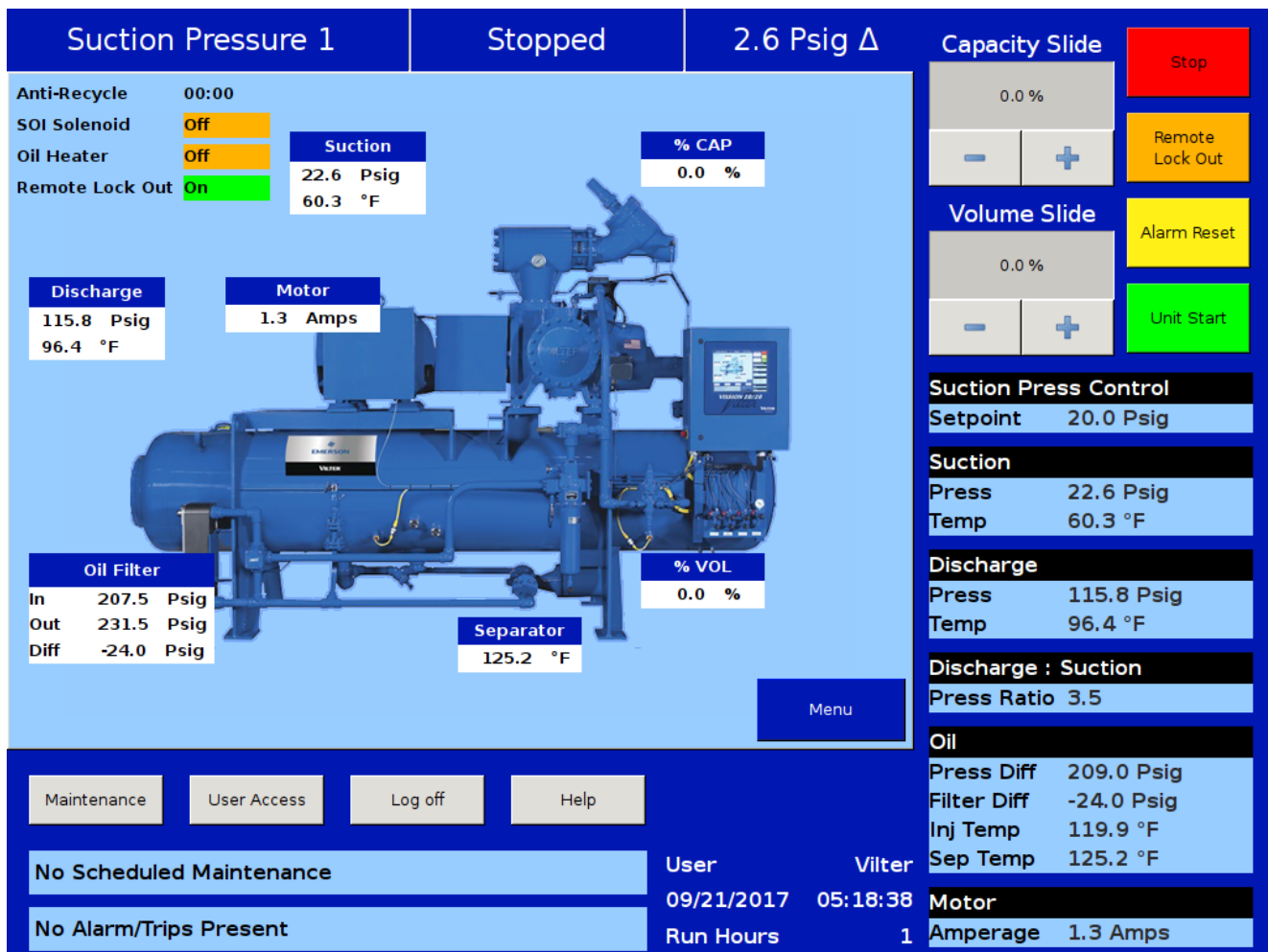

Figure 4-8. SOI Solenoid Screen

## Section 4 • Main Screen

### Configurable Main Screen

To use the Configurable Main Screen, the “Display Background Image” box in Configuration Page 2 (Touchscreen section) must be unchecked (default state is Enabled). If the checkbox is enabled, only the background image of the compressor will be displayed.

The Configurable Main Screen has four tables. The top left corner table will display values such as Anti-Recycle Time & State for the Oil Pump, Oil Heater, SOI Solenoid, Separator Level, Low VI, High VI & Remote Lock Out Digital Outputs. Please see Figures 4-9,4-10,4-11,4-12.

The other 3 Tables are user-configured and will display values as per the settings in pages 3 & 4 of the configuration screen. Please see Figure 4-9. No values will be displayed in these tables if “None” is selected on the Configuration Screen (see Figure 19-6). Please see Figure 4-13 for the default view.

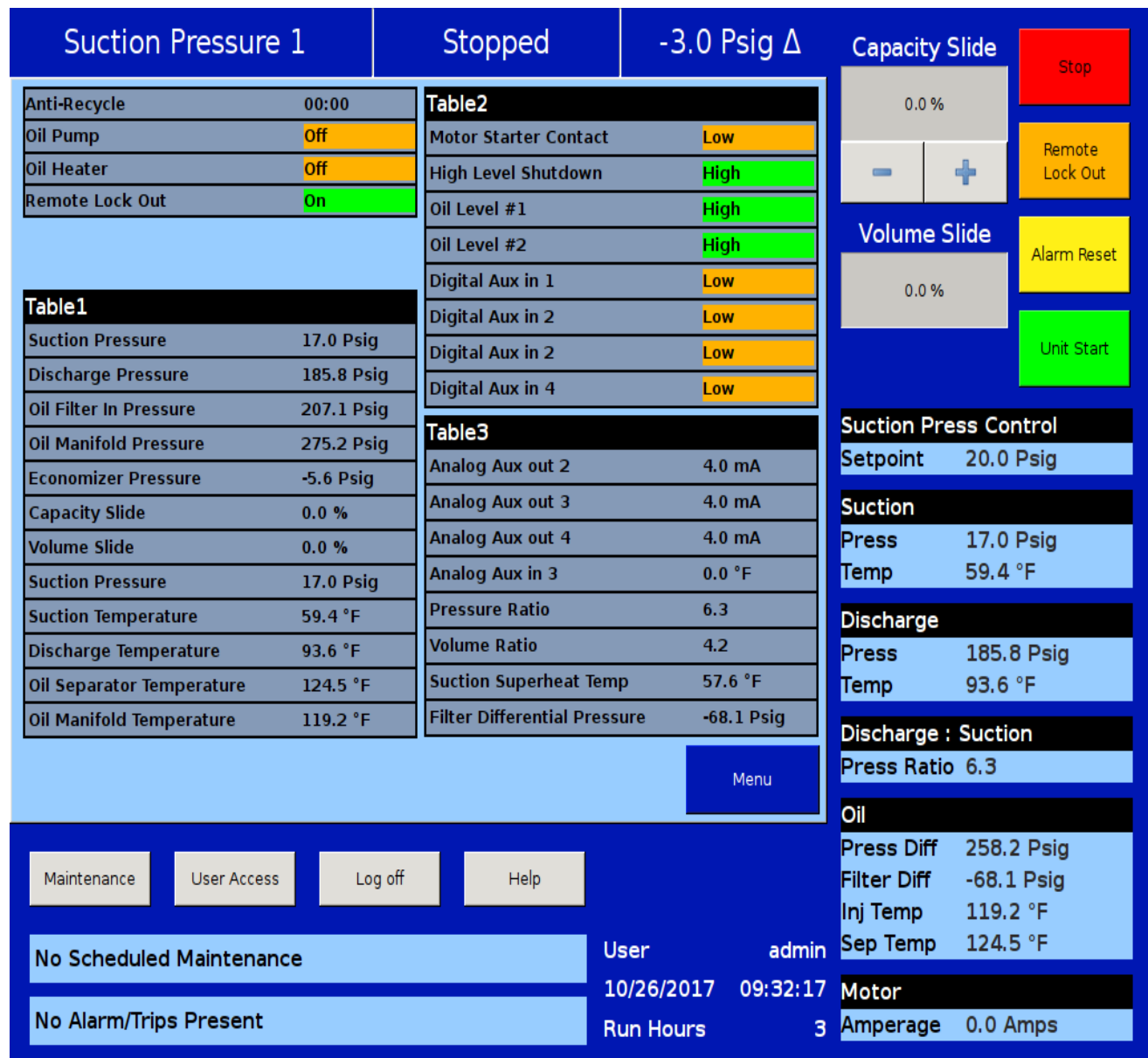

Figure 4-9. Configurable Main Screen with Oil Pump and Oil Heater

## Section 4 • Main Screen

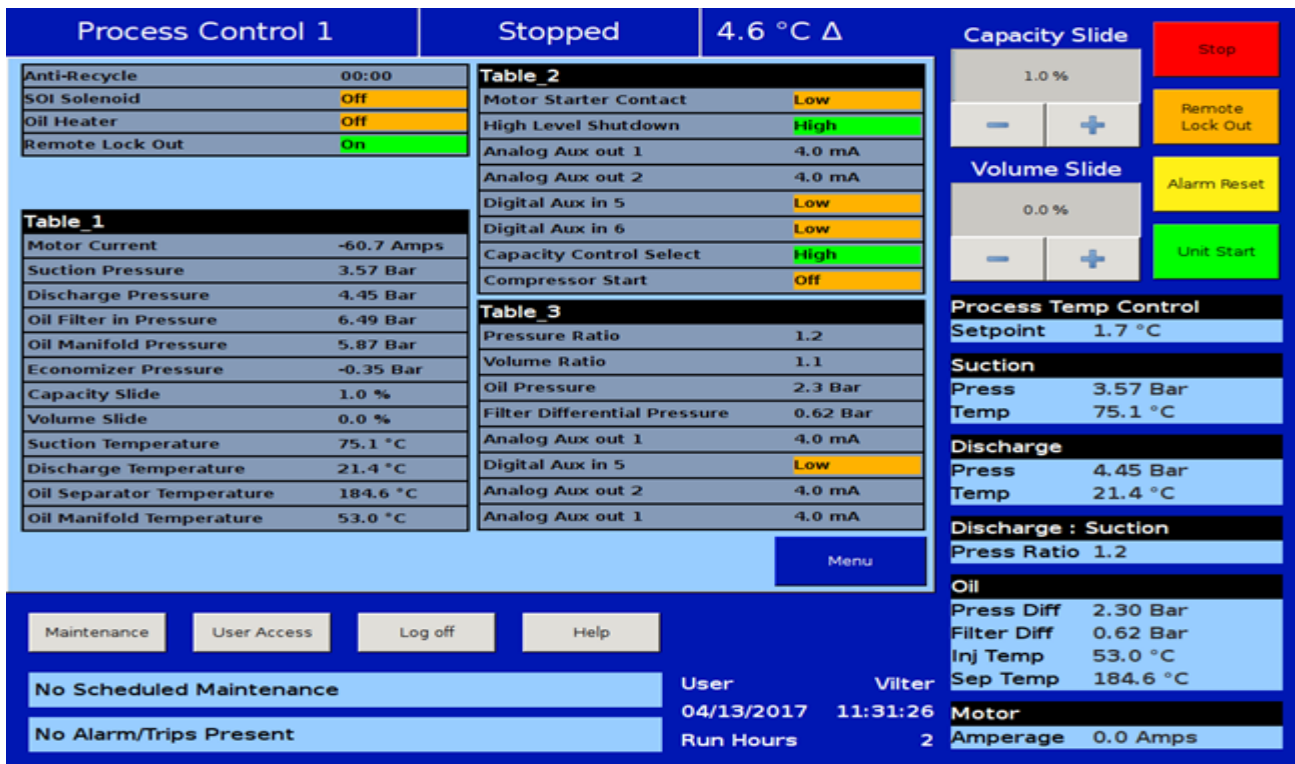

Figure 4-10. Configurable Main Screen with SOI Solenoid and Oil Heater



Figure 4-11. Configurable Main Screen with SOI Solenoid and Separator Level

## Section 4 • Main Screen

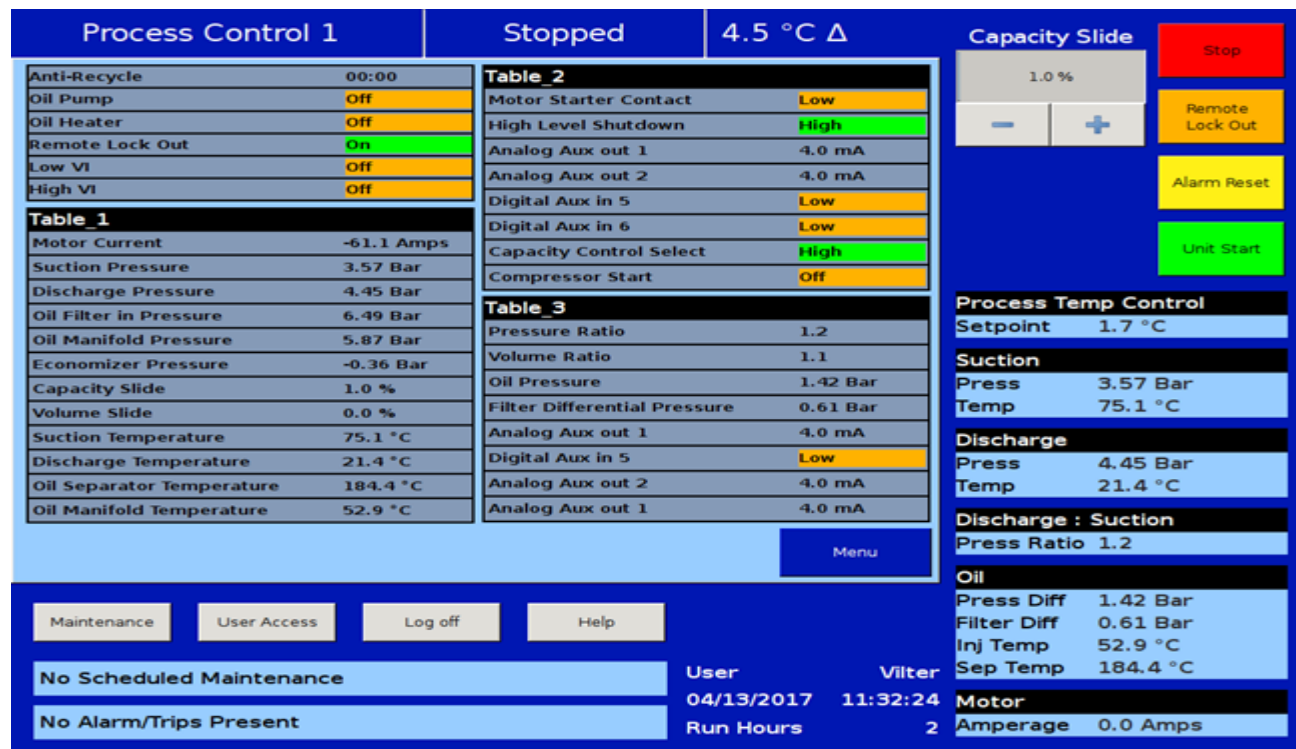

Figure 4-12. Configurable Main Screen with Step VI

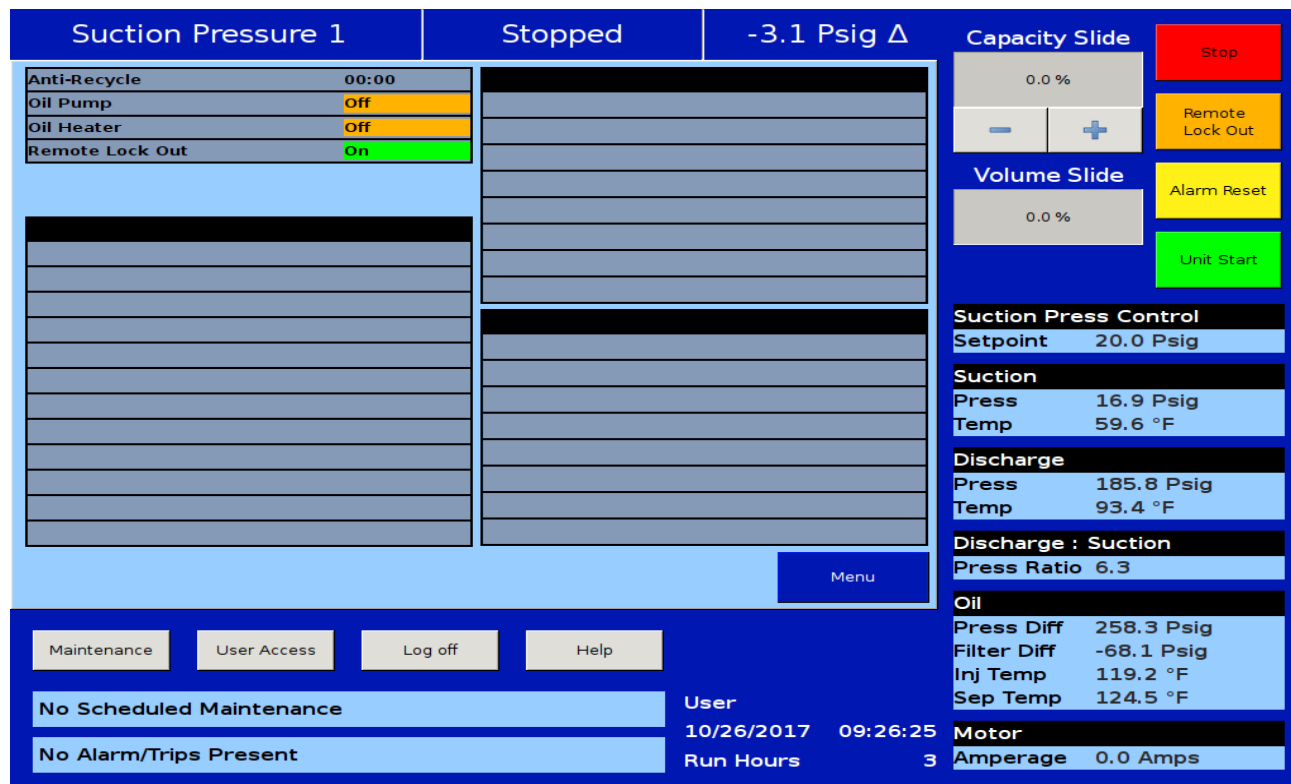

Figure 4-13. Configurable Main Screen Default View

## Section 5 • Menu Screen

### Overview

The menu screen is the launching point to every other section of the Vision 20/20 panel software. Every screen navigated to from this screen will return to the menu screen upon exiting, see Figure 5-1.

### Navigation Buttons

Compressor Control:

- Navigates to the compressor control screen where the operator can set the various compressor control parameters.

Alarms and Trips:

- Navigates to the alarms and trips screen where the operator can set the various alarm and trip parameters.

Timers:

- Navigates to the timer screen where the operator can set the various time related parameters.

Compressor Scheduling:

- Navigates to the compressor scheduling screen where the operator can set the scheduler to change the control method at settable dates and times.

Compressor Sequencing:

- Navigates to the compressor sequencing screen where the operator can set-up compressor to sequence up to nine other compressors. This is also sometimes known as lead-lag control. Note, as well, that Compressor Sequencing will only be available when it has been enabled from Configuration Page 1, and the selected compressor is the master.

Condenser Control:

- Navigates to the condenser control screen where the operator can set up local condenser control parameter.

Vilter™ VFD:

- Not currently available.

Service Options:

- Navigates to the service options screen where the

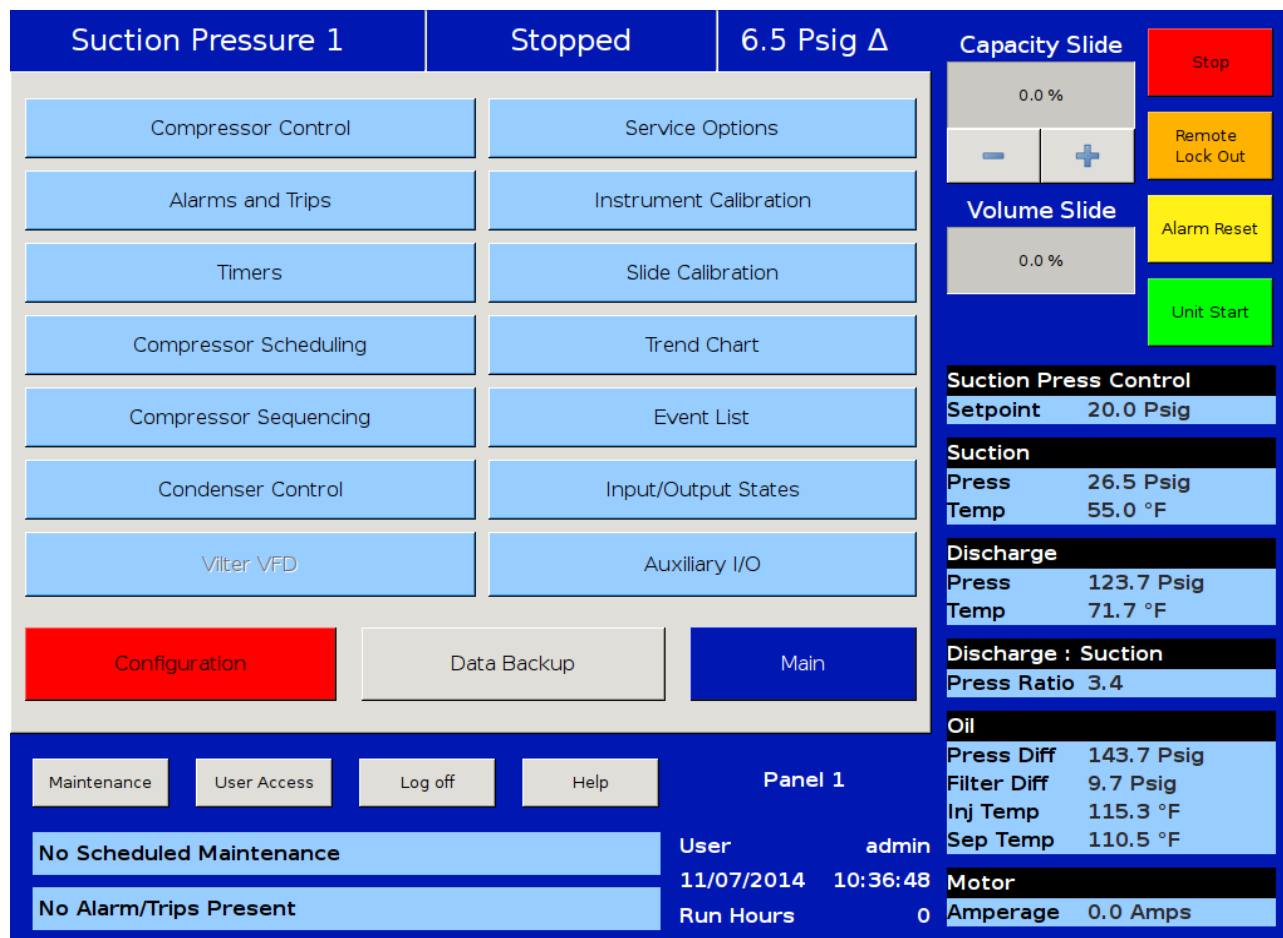

Figure 5-1. Menu Screen

## Section 5 • Menu Screen

operator can manually turn on/off digital and analog outputs for maintenance and diagnostics purposes.

Instrument Calibration:

- Navigates to the instrument calibration screen where the operator can calibrate all of the system sensors.

Slide Calibration:

- Navigates to the slide calibration screen where the operator can calibrate the capacity and volume slide actuators.

Trend Chart:

- Navigates to the trend chart screen where the operator can select up to four parameters for graphical historical data trending.

Event List:

- Navigates to the event list screen where the operator can view the systems events such as trips or alarms in descending chronological order.

Input/Output States:

- Allows viewing of the live data of all analog and digital input and outputs. Also allows viewing of a “snap shot” of all analog and digital input and outputs at

the time of the last compressor fault event.

Auxiliary I/O

- Navigates to the auxiliary I/O screen where an operator can configure any auxiliary instruments or devices.

Configuration:

- Navigates to configuration screens where the initial system parameters are configured.

Data Backup:

- Allows the operator to backup setpoints, configuration parameters, and calibration settings to a USB memory device. In addition, this allows the restoration of previously saved database files.

Main:

- Navigates back to the main screen.

Remote Oil Cooler:

- Navigates to the Remote Oil Cooler screen where the operator can set up local Remote Oil Cooler control parameter. Menu screen will show this option in place of condenser control option when enabled, see Figure 5-2.

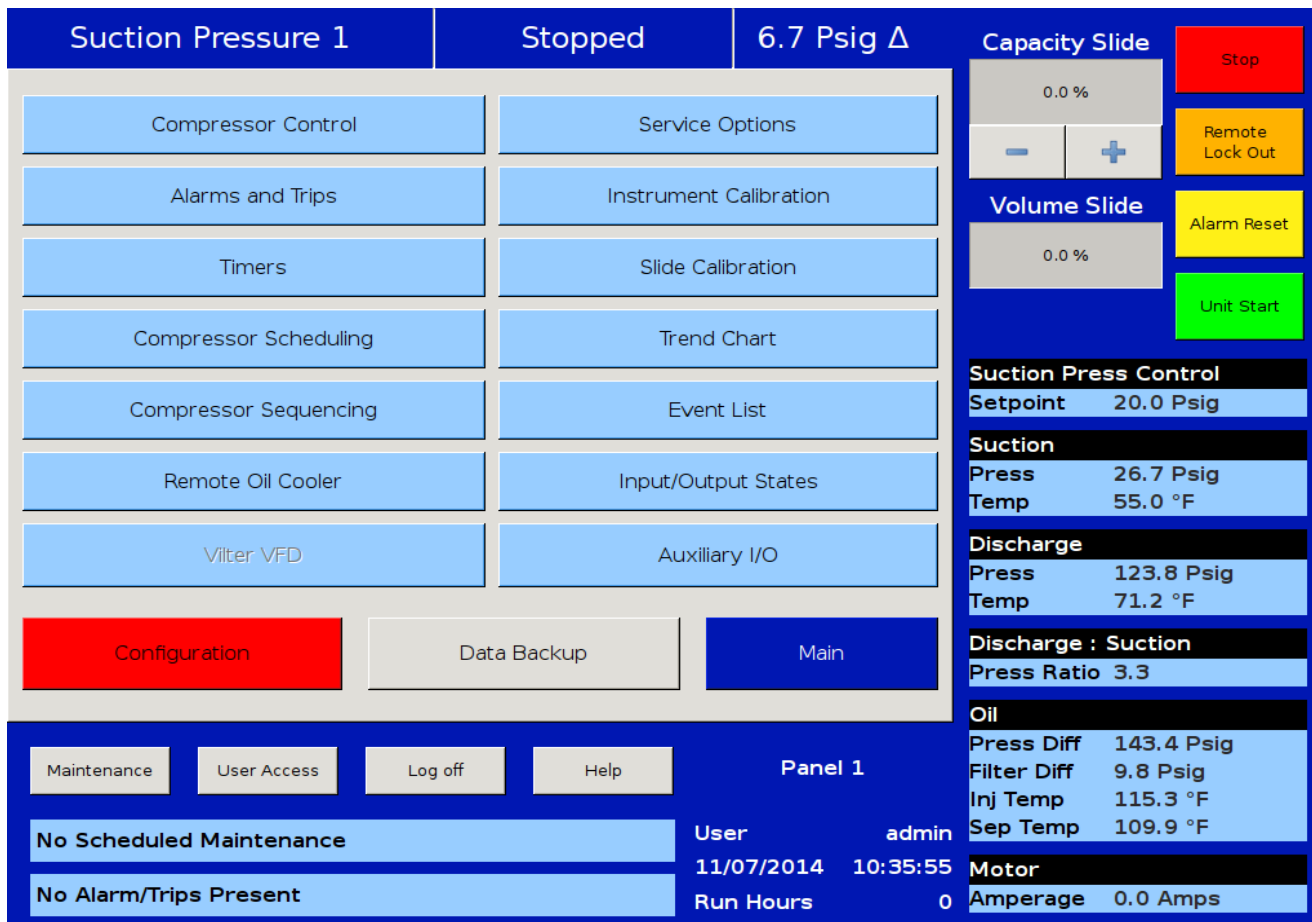

Figure 5-2. Menu Screen with Remote Oil Cooler Enabled



## Section 6 • Compressor Control

### Overview

The compressor control screen is where an operator can set the majority of the compressor settings. These settings define how the compressor will operate and respond to changing loads. The compressor control screen consists of several screens, but in order not to overwhelm the operator with options, many of the screens may not be visible.

#### NOTE

How the compressor is set up in the configuration screen (Section 19) will determine what compressor control pages are displayed. Additional setup information can be found in Appendix B.

It is important to note that there isn't one correct way to set these parameters. Every application is different and requires the operator to tune these settings to achieve the best operation.

### Suction Pressure Control, Process Temperature Control, Process Pressure Control and Discharge Pressure Control

The Vission 20/20 uses a pulse proportional control method to control the compressor capacity slide valve in order to maintain the control setpoint. The control setpoint can either be the suction pressure control setpoint, process temperature control setpoint, process pressure control setpoint or discharge pressure control setpoint depending on what the operator has selected as the control mode. For screens, see Figure 6-1, Figure 6-2, Figure 6-3 and Figure 6-5.

The proportional control uses the Interval Time Setpoint to define the time that the algorithm waits to read the current setpoint and calculate the error from the process control setpoint. Based on the error from setpoint, the algorithm calculates a pulse time in which the capacity slide is moved in the direction of the error. The further away the process variable is from the control setpoint,

The screenshot shows the 'Suction Pressure Control' screen. At the top, it indicates 'Suction Pressure 1', 'Stopped' status, and a pressure difference of '6.6 Psig Δ'. The main control area includes 'Suction Pressure Control' settings for two setpoints (Setpoint 1 and Setpoint 2) with parameters for Pressure Control Setpoint, Capacity Increase, Interval / Pulse Time, Proportional / Dead Band, Capacity Decrease, and Auto-cycle options. The right sidebar shows 'Capacity Slide' and 'Volume Slide' controls, both at 0.0%, along with 'Stop', 'Remote Lock Out', 'Alarm Reset', and 'Unit Start' buttons. A status panel on the right displays 'Suction Press Control Setpoint 20.0 Psig', 'Suction Press 26.6 Psig', 'Suction Temp 54.6 °F', 'Discharge Press 123.8 Psig', 'Discharge Temp 71.5 °F', and 'Discharge : Suction Press Ratio 3.4'. The bottom status bar shows 'Oil Press Diff 143.7 Psig', 'Filter Diff 9.5 Psig', 'Inj Temp 115.3 °F', 'Sep Temp 110.5 °F', 'Motor Amperage 0.0 Amps', and system information like 'User admin', 'Date 11/07/2014', 'Time 10:41:33', and 'Run Hours 0'.

Figure 6-1. Compressor Control Screen - Suction Pressure Control

## Section 6 • Compressor Control

the larger the corrective pulse will be. The duration of the pulse is limited by the Pulse Time Setpoint. By default the maximum pulse time is the same as the interval time. This means that the pulse time can be 100% of the interval time given a near continuous movement of the capacity slide. Adjusting these setpoints can be useful in slowing down the reaction time of the compressor if large thermal time contents are present in the refrigeration cycle. As mentioned in the above paragraph, the distance of the process variable from the control setpoint determines the size of the pulse used to move the capacity slide. This is called the proportional band and is set by the Proportional Setpoint. When the process variable is outside the proportional band, the slide will move in the direction of the error continuously. Increasing the size of the proportional band can help slow the compressors reaction by varying loads if desired, see Figure 6-4.

The Deadband Setpoint defines the area around the control setpoint where the algorithm stops adjusting the capacity slide. This area is a percentage of the proportional band. By default the proportional band is set to 4 Psig and the deadband is set to 10% of 4 Psig. Making

the deadband +/- 0.4 Psig of the control setpoint. Once the process variable is within the deadband, the algorithm considers the compressor to be on setpoint. If the operator wishes the compressor to operate closer, the setpoint can be set to a smaller percentage. However this will result in the capacity slide excessively moving to maintain the setpoint and could over heat the actuator or shorten the actuator's operational life.

### Auto-Cycle

The auto-cycle setpoints define the control points in which the compressor will automatically cycle on and off when placed into "Auto" run mode. These setpoints can be "enabled" or "disabled" using the check box. A delay can be entered to momentarily delay the start or stop from immediately occurring when the setpoint is met. If a compressor shutdown is desired on a suction pressure drop and a manual reset is required, set the OFF value below the Low Suction Pressure safety trip value. This will shut down the compressor and a Reset will be

The screenshot shows the 'Process Temperature Control' interface. At the top, it indicates 'Process Temperature 1' is 'Stopped' with a deviation of '-6.9 °F Δ'. The main control area is divided into two columns for 'Setpoint 1' (35.0 °F) and 'Setpoint 2' (38.0 °F). Each setpoint has fields for 'Temperature Control Setpoint', 'Capacity Increase' (Interval/Pulse Time and Proportional/Dead Band), and 'Capacity Decrease' (Interval/Pulse Time and Proportional/Dead Band). Below this is the 'Auto-cycle' section with an 'Enable' checkbox and fields for 'Start Temperature', 'Start Delay', 'Stop Temperature', 'Stop Delay', and 'Min Slide Position'. On the right side, there are 'Capacity Slide' and 'Volume Slide' controls, both currently at 0.0%. Below these are buttons for 'Stop', 'Remote Lock Out', 'Alarm Reset', and 'Unit Start'. A summary panel on the right shows 'Process Temp Control' (Setpoint 35.0 °F), 'Suction' (Press 26.5 Psig, Temp 55.0 °F), 'Discharge' (Press 123.9 Psig, Temp 71.2 °F), 'Discharge : Suction' (Press Ratio 3.4), 'Oil' (Press Diff 143.7 Psig, Filter Diff 9.7 Psig, Inj Temp 115.3 °F, Sep Temp 110.3 °F), and 'Motor' (Amperage 0.0 Amps). The bottom of the screen features a navigation bar with 'Maintenance', 'User Access', 'Log off', and 'Help' buttons, a 'Panel 1' label, and status information: 'No Scheduled Maintenance', 'No Alarm/Trips Present', 'User admin', '11/07/2014 10:47:51', and 'Run Hours 0'.

Figure 6-2. Compressor Control Screen - Process Temperature Control



## Section 6 • Compressor Control

required to restart it.

The auto-cycle function will operate only in local “Auto” mode and Direct I/O “Remote Auto” mode. If the auto-cycle feature is enabled while running in any other remote mode, the function will simply be ignored. However, the Minimum slide position will continue to be respected in “Remote “Auto” mode. If the compressor changes from a remote mode back to Local “Auto” mode, the auto-cycle feature will operate normally.

### NOTE

When the Pumpdown feature is enabled, the Auto-cycle setpoints are automatically disabled. Pumpdown mode will cause the compressor to cycle off via the Pumpdown Stop Pressure setpoint, and will not allow the compressor to start again.

Enable:

- Enables the Auto-cycle control. Uncheck the box to disable the Auto-cycle setpoints.

Start Pressure:

- When the suction pressure meets or exceeds this setpoint, the compressor will start.

Start Delay:

- Delays the compressor from starting when the suction pressure meets or exceeds this setpoint.

Stop Pressure:

- When the suction pressure meets or falls below this setpoint, the compressor will stop.

Stop Delay:

- Delays the compressor from stopping when the suction pressure meets or exceeds this setpoint.

Minimum Slide Position:

- The minimum capacity slide position that the compressor is allowed to run at.

The screenshot displays the 'Process Pressure Control' interface. At the top, it shows 'Process Control 1' is 'Stopped' at a pressure of '122.9 Psig Δ'. The main control area is divided into 'Process Pressure Control' and 'Auto-cycle' sections. The 'Process Pressure Control' section includes 'Pressure Control Setpoint' (30.0 Psig), 'Capacity Increase' (4.0 sec interval, 4.0 Psig proportional), and 'Capacity Decrease' (4.0 sec interval, 4.0 Psig proportional). The 'Auto-cycle' section has an 'Enable' checkbox (unchecked) and setpoints for 'Start Pressure' (28.0 Psig), 'Start Delay' (5 sec), 'Stop Pressure' (16.0 Psig), 'Stop Delay' (5 sec), and 'Min Slide Position' (10%). On the right, there are 'Capacity Slide' (0.1%) and 'Volume Slide' (0.0%) controls with 'Stop', 'Remote Lock Out', 'Alarm Reset', and 'Unit Start' buttons. A 'Process Press Control' summary shows 'Setpoint 30.0 Psig'. 'Suction' data: Press 43.6 Psig, Temp 26.2 °F. 'Discharge' data: Press 177.4 Psig, Temp -3.9 °F. 'Discharge : Suction' ratio is 3.3. 'Oil' data: Press Diff 118.8 Psig, Filter Diff 5.7 Psig, Inj Temp 78.6 °F, Sep Temp 191.2 °F. 'Motor' data: Amperage 0.0 Amps. The bottom status bar shows 'No Scheduled Maintenance', 'No Alarm/Trips Present', 'User admin', '07/15/2015 11:44:13', and 'Run Hours 0'.

Figure 6-3. Compressor Control Screen - Process Pressure Control

## Section 6 • Compressor Control

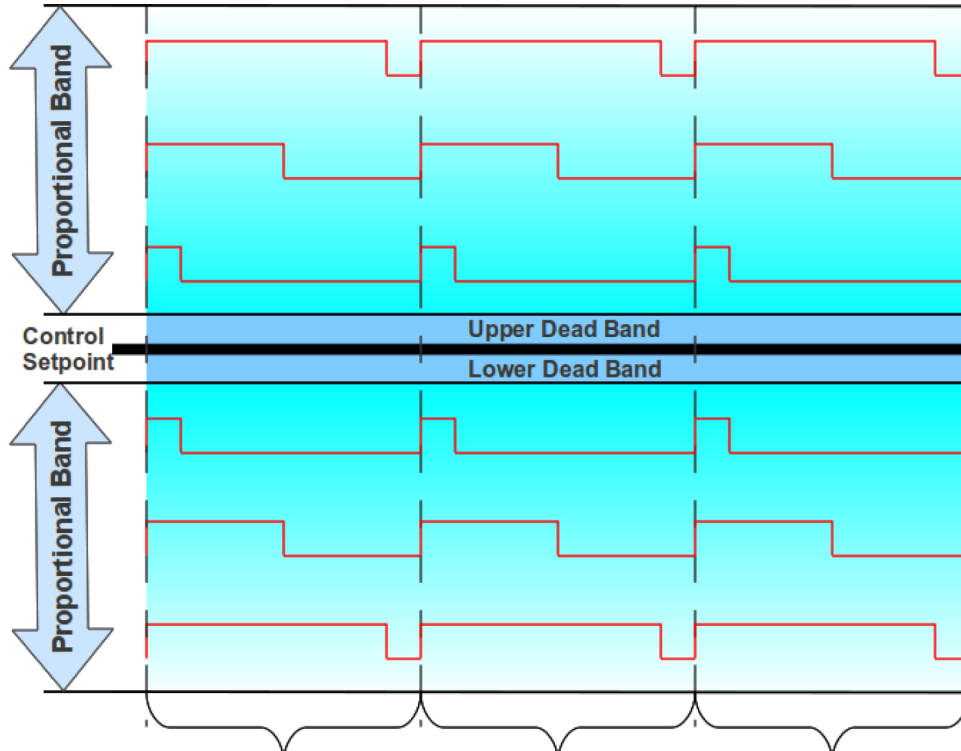

Figure 6-4. Proportional Band & Setpoint

Discharge Pressure 1
Stopped
136.5 Psig  $\Delta$

Discharge Pressure Control	
Pressure Control Setpoint	Setpoint 1: 260.0 Psig
Capacity Increase	4.0 sec
Interval / Pulse Time	4.0 sec
Proportional / Dead Band	4.0 Psig
Capacity Decrease	4.0 sec
Interval / Pulse Time	4.0 sec
Proportional / Dead Band	4.0 Psig

Auto-cycle	
<input type="checkbox"/> Enable	
Start Pressure	240.0 Psig
Start Delay	5 sec
Stop Pressure	280.0 Psig
Stop Delay	5 sec
Min Slide Position	10 %

Capacity Slide

0.0 %

- +

Volume Slide

0.0 %

Discharge Press Control

Setpoint 260.0 Psig

Suction

Press 26.5 Psig

Temp 54.6 °F

Discharge

Press 123.8 Psig

Temp 71.5 °F

Discharge : Suction

Press Ratio 3.4

Oil

Press Diff 143.8 Psig

Filter Diff 9.5 Psig

Inj Temp 115.1 °F

Sep Temp 110.3 °F

Motor

Amperage 0.0 Amps

Page 1 2 3 4 5

Maintenance User Access Log off Help

No Scheduled Maintenance

No Alarm/Trips Present

Panel 1

User admin

11/07/2014 10:45:56

Run Hours 0

Figure 6-5. Compressor Control Screen - Discharge Pressure Control

## Section 6 • Compressor Control

### Variable Frequency Drive (VFD) Settings Control

The VFD page is where the operator can tune the motor VFD for desired operation, see Figure 6-6. Compressor Control Screen - VFD Settings Control. A Vilter™ compressor uses the variable speed of a VFD controlled motor to vary the amount of work or capacity of the compressor. The basic one step VFD control will use the capacity slide to control the first half of the total available capacity and the motor speed to control the second half of the total available capacity, see Figure 6-7, VFD One-Step Control Method. For example, if the compressor needs to load to 100% of its capacity, the control algorithm will first move the capacity slide to its maximum position, and then the motor speed will ramp up to its maximum speed. In the unloading direction, the motor speed will ramp down to its minimum speed, and then the capacity slide will move to its minimum position.

The two-step control method works much like the one-step method but divides the control into four sections,

see Figure 6-8. While loading the compressor will first move the capacity slide to the maximum set for step one, then speed up the motor to its maximum speed for the same step. Once step one has completed, the control algorithm will again move the capacity slide to the maximum position and the maximum motor speed of step two. At this point the compressor would be fully loaded. Unloading occurs in the reverse direction. The two-step control method is not typical for most installations and is normally used when a Vilter™ engineer recommends it.

#### NOTE

VFD installation is not covered in this manual. A VFD that is not properly installed and configured has the potential of causing intermittent and dangerous problems. Please consult your VFD manual.

1 Step VFD Control:

- Enables the first step in the VFD control algorithm. This check box cannot be unselected by the operator.

The screenshot displays the VFD Settings Control interface. At the top, it shows 'Suction Pressure 1', 'Stopped' status, and '6.6 Psig Δ'. The main area is divided into 'VFD Settings' and a right-hand panel. The VFD Settings section includes input fields for 'P' (1), 'I' (1), and 'D' (0). Below this, there are two control methods: '1 Step VFD Control' (checked) and '2 Step VFD Control' (unchecked). Each method has 'Capacity Slide Position' and 'VFD Speed' settings for 'Minimum' and 'Maximum' values. The right-hand panel features 'Capacity Slide' and 'Volume Slide' controls, both at 0.0%, with 'Stop', 'Remote Lock Out', 'Alarm Reset', and 'Unit Start' buttons. Below these are status indicators for 'Suction Press Control' (Setpoint 20.0 Psig), 'Suction' (Press 26.6 Psig, Temp 55.0 °F), 'Discharge' (Press 123.8 Psig, Temp 71.5 °F), and 'Discharge : Suction Press Ratio 3.4'. At the bottom right, 'Oil' and 'Motor' status are shown (Press Diff 143.6 Psig, Filter Diff 9.7 Psig, Inj Temp 115.1 °F, Sep Temp 110.3 °F, Motor Amperage 0.0 Amps). The bottom of the screen contains navigation buttons (Maintenance, User Access, Log off, Help), a 'Panel 1' label, and system status: 'No Scheduled Maintenance', 'No Alarm/Trips Present', 'User admin', '11/07/2014 10:50:09', and 'Run Hours 0'.

Figure 6-6. Compressor Control Screen - VFD Settings Control

## Section 6 • Compressor Control

### Capacity Slide Position:

- Defines the minimum and maximum positions for the capacity slide. While in 1 step control these values should be 0% for minimum and 100% for maximum.

### VFD Speed:

- Defines the minimum and maximum speed for the motor. While in 1 step control these values should reflect the full range of the VFD.

### 2 Step VFD Control:

- Enables the second step in the VFD control algorithm.

### Capacity Slide Position:

- Defines the minimum and maximum position of the capacity slide in the 2 step VFD control.

### VFD Speed:

- Defines the minimum and maximum speed for the motor in the 2 step VFD control.

### P = Proportional (gain) setpoint:

- Used to adjust the motor speed action in direct proportion to the difference between the control setpoint and the process variable (SP - PV error). This is a unitless quantity and is used for coarse adjustment. This setpoint should be set to the lowest value that

gives adequate control system response. Increasing the proportional setting increases the control system's sensitivity to small process fluctuations and the tendency to hunt.

### I = Integral (reset) setpoint:

- Used to adjust the capacity control action, integrating the error over time, to account for a small error that has persisted for a long time. This quantity is used for fine adjustment. This setpoint is used to smooth out process variations. This setpoint should be set high enough to prevent hunting but low enough to prevent control system overshoot.

### D = Derivative (rate) setpoint:

- Used to adjust the capacity control action, accounting for how fast the error is changing, positively or negatively. A standard PID loop variable, it is not used for our applications.

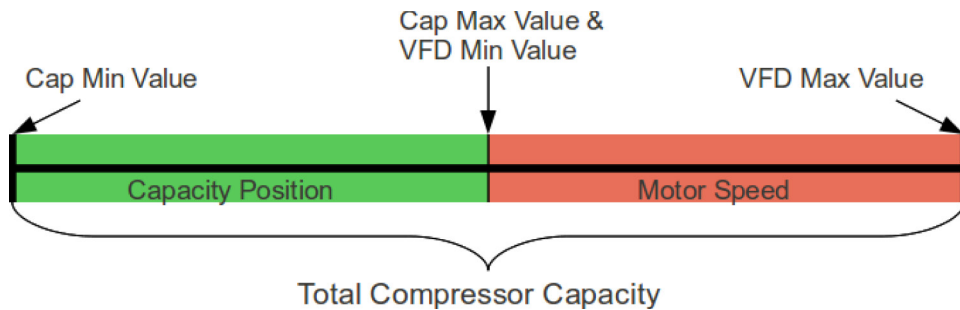

Figure 6-7. VFD One-Step Control Method



Figure 6-8. VFD Two-Step Control Method

## Section 6 • Compressor Control

### Oil Restriction Solenoid

The Oil Restriction Solenoid feature controls the Oil Restriction Solenoid Digital Output, see Figure 6-9. The Oil Restriction Feature will control the Digital Output according to VFD RPM Speed. This function can be selected along with Compressor VFD / Rapid Cycling VFD.

#### VFD Speed Range:

- Defines the Minimum and Maximum speed for the motor. These values should reflect the full range of the VFD.

#### Warm up Timer:

- Defines the Warm up period for the Compressor. This timer gets activated after every compressor start and remains active for the defined time. During this period, the Oil Pump is turned ON and the motor speed is varied from 1200 RPM to 3600 RPM.

#### Oil Restriction Setpoint:

- This is Compressor VFD RPM setpoint used for turning ON/OFF the Oil Solenoid Digital Output. Oil Solenoid Digital Output is turned ON when Compressor is Running and Compressor VFD RPM goes below this setpoint.

#### Oil Restriction Differential:

- This is the differential around Oil Restriction Setpoint.

#### State Below Setpoint:

- This is the Oil Restriction Solenoid State selection Setpoint. The user can select the Oil Restriction Solenoid Digital Output State as “N.O.” or “N.C.”. Oil Restriction Solenoid Digital Output will be controlled according to state selection. For example, if Oil Restriction Setpoint is set to 1800 RPM , Oil Restriction Offset is set to 5 RPM and State Below Setpoint as “N.O.”, then as Compressor VFD RPM decreases to 1795 RPM, then Oil Solenoid Digital Output will be turned OFF. If Compressor VFD RPM increases to 1805 RPM, then Oil Solenoid Digital Output will be turned ON.

The screenshot displays the Compressor Control interface. At the top, it shows 'Suction Pressure 1', 'Stopped' status, and '3.1 Psig Δ'. The main 'VFD Settings' panel includes:
 

- Setpoint: P (1.0), I (1.0), D (0.0)
- Oil Restriction Solenoid: Oil Restriction Setpoint (1200 rpm), Oil Restriction Differential (5 rpm), State Below Setpoint (N.O. selected)
- VFD Control: 1 Step VFD Control (checked) with Capacity Slide (0% to 100%) and VFD Speed (1800 rpm to 3600 rpm); 2 Step VFD Control (unchecked) with Capacity Slide (100% to 100%) and VFD Speed (3600 rpm to 3600 rpm)

 The right sidebar contains:
 

- Capacity Slide (0.0%) with Stop, Remote Lock Out, and Alarm Reset buttons.
- Volume Slide (3.3%) with Unit Start button.
- Suction Press Control (Setpoint 20.0 Psig)
- Suction (Press 23.1 Psig, Temp 114.0 °F)
- Discharge (Press 121.1 Psig, Temp -90.5 °F)
- Discharge : Suction (Press Ratio 3.6)
- Oil (Press Diff 129.6 Psig, Filter Diff -3.5 Psig, Inj Temp 121.3 °F, Sep Temp 156.5 °F)
- Motor (Amperage 0.0 Amps)

 The bottom navigation bar includes Maintenance, User Access, Log off, and Help buttons. Status messages at the bottom indicate 'No Scheduled Maintenance' and 'No Alarm/Trips Present'. User information shows 'User admin', '06/29/2016 06:35:03', and 'Run Hours 0'.

Figure 6-9. Compressor Control Screen - Oil Restriction Solenoid

## Section 6 • Compressor Control

### Rapid Cycling VFD Control

Operation at variable speed provides constant load-matching capacity and energy saving by eliminating over-capacity running.

However, refrigeration compressors that use speed control are operated outside the normal area of operation defined and specified by the manufacturer. It is therefore very important to take into consideration certain electrical and refrigeration technology restraints.

That is why this is a Special Compressor Setting that only a Vilter™ user can activate, with knowledge of installation data, to make sure the equipment you have is compatible with the set up, and that you have available all hardware (such as Digital Input/Output Card #5, that will allow you to control the Oil Restriction Solenoid), so that the Rapid Cycling VFD Control can work fluidly in your application.

If at any point changes are made to your application, configuration or equipment, you will need to consult a

Vilter™ engineer on how to apply those changes to the use of the Rapid Cycling VFD Control feature.

The VFD page is where the operator can tune the motor VFD for desired rapid cycling VFD operation, see Figure 6-10. A Vilter™ compressor uses the variable speed of a VFD controlled motor to vary the amount of work or capacity of the compressor. The rapid Cycling VFD control will keep the capacity slide loaded to maximum and vary the motor speed to achieve the required work or capacity. For example, if the compressor needs to load to 100% of its capacity. The control algorithm will keep the capacity slide loaded to its maximum position and ramp up the motor speed up to its maximum speed. In the unloading direction, the motor speed will ramp down to its minimum speed, keeping capacity slide loaded to maximum. In this manner, capacity load is handled by varying motor speed only. Oil Restriction Solenoid Function will be automatically enabled when Rapid Cycling VFD is selected in Configuration Screen. Refer to the Oil Restriction Solenoid Section for Oil Restriction Setpoint details.

Figure 6-10. Compressor Control Screen - Rapid Cycling VFD Control

## Section 6 • Compressor Control

---

### Oil Restriction Setpoint:

- This is the compressor VFD RPM setpoint used for turning ON/OFF the Oil Solenoid Digital Output. Oil Solenoid Digital Output is turned ON when the compressor is Running, Warm up Timer is Lapsed and Compressor VFD RPM goes below this setpoint.

### Oil Restriction Differential:

- This is the differential around Oil Restriction Setpoint.

### Oil Restriction Offset:

- This is the differential offset around Oil Restriction Setpoint. For example, if Oil Restriction Setpoint is set to 1800 RPM and Oil Restriction Offset is set to 5 RPM, then as Compressor VFD RPM decreases to

1795 RPM, then Oil Solenoid Digital Output will be turned ON. If Compressor VFD RPM increases to 1805 RPM, then Oil Solenoid Digital Output will be turned OFF.

## Pumpdown Control

### NOTE

For use of compressor control screen - page 4, see Cool Compression Control in Section 25.

The Pumpdown Control defines a method of “pumping” down a chiller, which is to draw off refrigerant from it. This feature can be enabled or disabled from this page, see Figure 6-11. If Pumpdown is enabled, this feature will only function when the compressor is running in local Auto Mode and Control Mode Configured is Suction Pressure.

When Pumpdown Control is running, a status icon will appear on the bottom left corner of the main screen to make the user aware of it.

If the Pumpdown Feature is enabled, then;

- The Auto-cycle functionality is ignored. Pumpdown mode will cause the compressor to cycle off via the Pumpdown Stop Pressure setpoint. Normally, the Pumpdown Stop Pressure setpoint will be set lower than the Auto-cycle Stop setpoint. Therefore, as the suction pressure is pulled down, the compressor is prevented from shutting down prematurely via the Auto-cycle Stop setpoint by automatically ignoring the Auto-cycle feature.
- The compressor will be placed into “Stop” mode after the suction pressure is equal to, or goes below the Pumpdown Stop Pressure.

### Pumpdown:

- This checkbox enables the Pumpdown feature. If this box is unchecked, the Pumpdown setpoints are ignored and the user is not allowed to edit them.

### Stop Pressure:

- This setpoint defines the suction pressure value at which the compressor will cycle off. Normally, this setpoint is set below the Suction Pressure Auto-cycle Stop Pressure setpoint.

### Stop Delay:

- This setpoint delays the compressor from stopping when the suction pressure is equal to or less than the Stop Pressure.

### Min Slide Position:

- The minimum capacity slide is the setpoint that the compressor is allowed to run at. By forcing the compressor capacity to operate at a value above minimum, we insure that the suction pressure will be pulled down to the Stop Pressure setpoint.

### Pumpdown Operation (Run/Stop):

- This button starts/stops the Pumpdown operation. This button is active only when compressor is in local Auto mode and the Control Mode configured is Suction Pressure. This button will display “Run” when Pumpdown operation has not started or stopped, while button will display “Stop” when Pumpdown operation is running.

When the Pumpdown feature is enabled, the Pulldown checkbox is automatically grayed out. Similarly when Pulldown feature is enabled, the Pumpdown checkbox



## Section 6 • Compressor Control

is automatically grayed out and hence, the user will not be able to operate the Pumpdown feature. This is done to keep the Pumpdown and Pulldown features mutually exclusive.

### Pulldown Control

The Pulldown Control defines a method of slowly pulling the suction pressure down from a high value. This is sometimes required on systems that have liquid recirculation systems or on new building to prevent structural damage by limiting the rate at which the building should be cooled.

This feature can be enabled or disabled from this page, see Figure 6-11. If Pulldown is enabled, this feature will only function when the compressor is running in local Auto, Auto Sequencing mode and when the Control mode is Suction Pressure 1.

The Pulldown feature provides a method to slowly pull the suction pressure down to operating conditions. The pulldown method used is to step the suction pressure down over a defined time interval.

Example:

Assume the suction pressure is at 85 psig and the setpoint we want to get to is 20 psig. The operator wants to allow 48 hours of pulldown time. Pick a reasonable step pressure of 5 psig for every step. This defines a change of  $(80 - 20 = 60)$  psig.

1. Note: the first step is applied immediately. So first step starts at  $(85 - 5 = 80)$  psig
2. Number of steps =  $\text{delta} (60 \text{ psig change} * 1 \text{ step}/5 \text{ psig}) = 12 \text{ steps}$ .
3. Delay per Step =  $(48 \text{ hours} / 12 \text{ steps}) = 4 \text{ hours/step}$ .
4. So for the first 4 hours, the compressor runs at 80 psig.
5. Next 4 hours @ 75 psig
6. Next 4 hours @ 70 psig
7. And so forth.

The screenshot displays the Compressor Control interface. At the top, the status is 'Suction Pressure 1' and 'Stopped' with a current pressure of '6.3 Psig Δ'. The main control area is divided into 'Pumpdown' and 'Pulldown' sections. The 'Pulldown' section is active, showing settings for 'Step Pressure' (5.0 Psig), 'Delay Per Step' (5.0 hour), and 'Stop Pressure' (20.0 Psig). A 'Run' button is visible. On the right, there are 'Capacity Slide' and 'Volume Slide' controls, both at 0.0%, and buttons for 'Stop', 'Remote Lock Out', 'Alarm Reset', and 'Unit Start'. Below these are real-time system data for 'Suction Press Control', 'Suction', 'Discharge', and 'Oil'. At the bottom, there are navigation buttons (Page 1-8, Menu), user access controls (Maintenance, User Access, Log off, Help), and system status indicators (No Scheduled Maintenance, No Alarm/Trips Present). The user is identified as 'admin' and the system shows 'Run Hours' as 0.

Suction Press Control	
Setpoint	20.0 Psig
Suction	
Press	26.3 Psig
Temp	55.0 °F
Discharge	
Press	123.7 Psig
Temp	71.7 °F
Superheat	-2.0 °F
Discharge : Suction	
Press Ratio	3.4
Oil	
Press Diff	143.8 Psig
Filter Diff	9.8 Psig
Inj Temp	115.1 °F
Sep Temp	110.3 °F
Motor	
Amperage	0.0 Amps

Figure 6-11. Compressor Control Screen - Pumpdown/Pulldown Control



## Section 6 • Compressor Control

---

After the 12th step (running at 25 psig), 48 hours will have elapsed, and the new setpoint becomes 20 psig, achieving the 20 psig setpoint after 48 hours. After the pulldown setpoint is equal to or is less than the control setpoint, the pulldown feature will disable itself.

**Pulldown:**

- This checkbox enables the Pulldown feature. If this box is unchecked, the Pulldown setpoints are ignored and the operator is not allowed to edit them.

**Initiate Pulldown at Next Start:**

- This checkbox, when enabled, turns on the Pulldown process at the next start cycle, and Pulldown operation will work in the following manners:
  - Pulldown only works when Control mode is Suction Pressure 1.
  - If not started in Suction Pressure 1 then Pulldown process will not run until stopped and restarted in Suction Pressure 1.
  - If started in Suction Pressure 1 and changed after start, then Pulldown process will be suspended and restarted once Control mode is changed back to Suction Pressure 1.

**Initiate Pulldown at Every Start:**

- This checkbox, when enabled, turns on the Pulldown process at every start cycle.
  - The Pulldown feature will not disable itself when the stop pressure setpoint is achieved and this checkbox is enabled.

**Step Pressure:**

- This setpoint defines the step decrements at which the suction pressure value will be controlled at.

**Delay Per Step:**

- This setpoint defines the time increment at which the compressor will be controlled at each step, in hours and minutes. Minimum range of 1, maximum of 1259.

**Stop Pressure:**

- This setpoint defines the suction pressure value at which the Pulldown operation will get completed. When the suction pressure value is equal to or goes below this setpoint, the Pulldown feature disables itself. Also “Pulldown” and “Initiate Pulldown at Next Start” checkboxes will be automatically deselected as normally this is a one time use feature.

**Auto Cycle Differential:**

- This setpoint defines the offset pressure values for Auto Cycle Start Pressure and Stop Pressure from the Suction Pressure setpoint. The Auto Cycle Start

Pressure setpoint will be the Suction Pressure setpoint increased by this setpoint pressure value, while the Auto Cycle Stop Pressure value will be the Suction Pressure setpoint decremented by this setpoint pressure value.

When the Pulldown feature is enabled, the Pumpdown checkbox is automatically grayed out. Similarly when the Pumpdown feature is enabled, the Pulldown checkbox is automatically grayed out and hence, the user will not be able to operate the Pulldown feature. This is done to keep the Pulldown & Pumpdown features mutually exclusive.

### Active Control Mode

This drop down box gives the operator the ability to change the type of Active Control Mode such as suction pressure, process control or discharge pressure. The operator can also switch from setpoint 1 and setpoint 2 for each control method. What is available in this dropdown box depends on the number and type of control selected in the configuration screen, see Figure 6-12.

### Load Anticipating

The purpose of the load anticipating algorithm is to reduce the amount of overshoot of the capacity slide position while the compressor attempts to meet the control setpoint. This advanced feature of the Vission 20/20 closely monitors the rate of change of the process variable and compares it to the control setpoint. If the process variable is changing in the direction of the control setpoint at the specified rate or greater, then the normal command to move the capacity slide is interrupted. The rate is calculated between time intervals set in the proportional control section of this screen.

**Enable Load Anticipation Algorithm:**

- Allows the operator to choose if the load anticipation algorithm runs.

**Rate Deadband:**

- Defines the rate at which the capacity slide movement will be interrupted. This value is an absolute value of the process variable. For example, the default value is 0.25. If the control mode is suction pressure, then this value is 0.25 Psig or if process temperature is the control mode then the value would be 0.25°F.

## Section 6 • Compressor Control

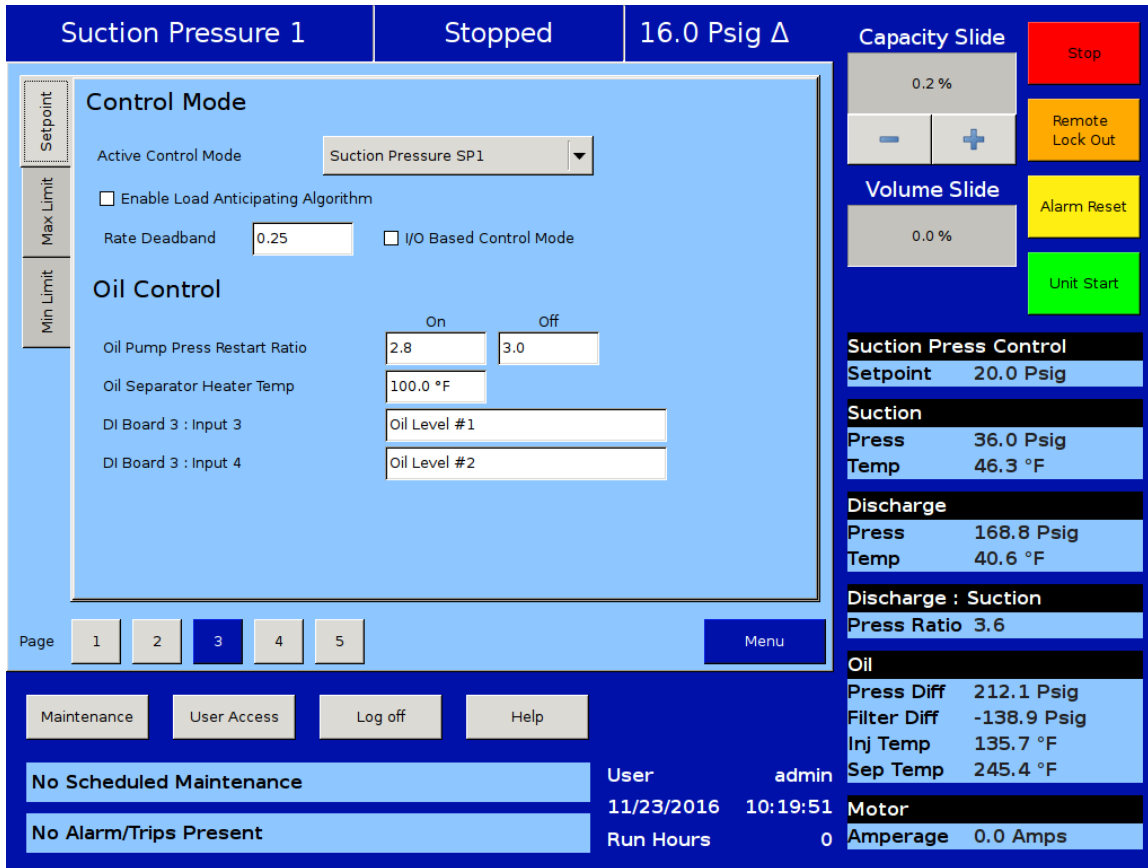

Figure 6-12. Compressor Control Screen - (Active Control Mode, Oil Control)

### I/O Based Control Mode:

- This checkbox, when enabled, monitors the Remote Select #1/#2 Digital Input (5th Digital Input on Digital Input Board 1). When Compressor is running in Auto / Remote(Auto) run mode, the selection of Active Control Setpoint depends upon the state of Remote Select #1/#2 Digital Input. When Remote Select #1/#2 digital input is Energized, Active Control Mode will be Setpoint 2. When Remote Select #1/#2 digital input is De-Energized Active Control Mode will be Setpoint 1.

### Oil Control

These setpoints determine how the Vision 20/20 will manage the compressor's oil, see Figure 6-12.

#### Oil Pump Press Restart Ratio:

- The on and off setpoints define when the oil pump will cycle on and off if the oil pump is selected to cycle from the configuration screen.

### Oil Separator Heater Temp:

- When the oil temperature falls below this setpoint the oil heater will turn on. Note, there is a 5°F differential associated with this setpoint. For example, when set at 100°F, the heater will turn on at 95°F and off at 105°F.

### DI Board 3: Input 3:

- This label offers flexibility to set name for digital input 3 on digital input board 3. User defined name set here is reflected in Timers, Input/Output States & Auxiliary I/O Screens

### DI Board 3: Input 4:

- This label offers flexibility to set name for digital input 4 on digital input board 3. User defined name set here is reflected in Timers, Input/Output States & Auxiliary I/O Screens

The Vision 20/20 offers the flexibility to control a SOI Solenoid when Oil Pump is not present. The SOI

## Section 6 • Compressor Control

The screenshot shows the 'Control Mode (SOI)' interface for a compressor. The top status bar indicates 'Suction Pressure 1', 'Stopped', and '16.0 Psig Δ'. The main control area includes:

- Control Mode:** Active Control Mode is 'Suction Pressure SP1'. There are checkboxes for 'Enable Load Anticipating Algorithm' and 'I/O Based Control Mode'. The Rate Deadband is set to 0.25.
- Oil Control:** Oil Separator Heater Temp is 100.0 °F. DI Board 3 : Input 3 is Oil Level #1, and DI Board 3 : Input 4 is Oil Level #2.
- Suction Oil Injection:** SOI Solenoid Press Restart Ratio has 'On' (2.8) and 'Off' (3.0) setpoints. SOI Solenoid ON Timer is 2.0 min. SOI Load Limit is 35%.

On the right side, there are control slides for Capacity (0.2%) and Volume (0.0%), along with buttons for Stop, Remote Lock Out, Alarm Reset, and Unit Start. A summary table on the right shows:

Suction Press Control	
Setpoint	20.0 Psig
Suction	
Press	36.0 Psig
Temp	46.3 °F
Discharge	
Press	168.5 Psig
Temp	40.4 °F
Discharge : Suction	
Press Ratio	3.6
Oil	
Press Diff	212.1 Psig
Filter Diff	-138.9 Psig
Inj Temp	135.7 °F
Sep Temp	245.1 °F
Motor	
Amperage	0.0 Amps

At the bottom, there are navigation buttons (Maintenance, User Access, Log off, Help), a status bar showing 'No Scheduled Maintenance' and 'No Alarm/Trips Present', and a user information section: User: Vilter, 11/23/2016 10:21:26, Run Hours: 0.

Figure 6-13. Compressor Control Screen - Control Mode (SOI)

Solenoid should be wired to “Oil Pump Start” Digital Output, see Figure 6-13.

SOI Solenoid Press Restart Ratio:

- The On and Off setpoints define when the SOI solenoid will Cycle On and Off depending on Discharge to Suction Pressure Ratio.

SOI Solenoid ON Timer:

- This setpoint defines the time interval for which the SOI Solenoid is Forced ON when the compressor is started or when the SOI Solenoid is Cycled On when the compressor is running.

SOI Load Limit:

- This setpoint defines the maximum value for the capacity slide position when SOI Solenoid is ON.No Oil Pump

Refer to Figure 6-14 for the No Oil Pump Control Setpoints. When No Pump is selected in the Configuration Screen, the Oil Pump digital Output is Forced OFF.

No Oil Pump Pressure Ratio:

- This setpoint defines the load limit condition of No Oil Pump when No Pump is selected in the configuration screen. This setpoint is monitored against Pressure Ratio.

No Oil Pump Load Limit:

- This setpoint defines the maximum value for the capacity slide position when the Pressure Ratio drops below the No Oil Pump Pressure Ratio Setpoint.

## Section 6 • Compressor Control

The screenshot displays the Compressor Control interface. At the top, it shows 'Suction Pressure 1', 'Stopped' status, and '16.1 Psig Δ'. The main control area includes:

- Control Mode:** Active Control Mode is 'Suction Pressure SP1'. There are checkboxes for 'Enable Load Anticipating Algorithm' and 'I/O Based Control Mode'. The Rate Deadband is set to 0.25.
- Oil Control:** Parameters include Oil Separator Heater Temp (100.0 °F), No Oil Pump Pressure Ratio (2.8), No Oil Pump Load Limit (40%), and DI Board 3 inputs for Oil Level #1 and #2.

On the right side, there are control slides for Capacity (0.2%) and Volume (0.0%), along with buttons for Stop, Remote Lock Out, Alarm Reset, and Unit Start. Below these are real-time data sections:

- Suction Press Control:** Setpoint 20.0 Psig
- Suction:** Press 36.1 Psig, Temp 46.3 °F
- Discharge:** Press 168.6 Psig, Temp 40.4 °F
- Discharge : Suction:** Press Ratio 3.6
- Oil:** Press Diff 212.2 Psig, Filter Diff -139.0 Psig, Inj Temp 135.9 °F, Sep Temp 245.1 °F
- Motor:** Amperage 0.0 Amps

At the bottom, there are navigation buttons (Maintenance, User Access, Log off, Help), status messages ('No Scheduled Maintenance', 'No Alarm/Trips Present'), and user information (User: 11/23/2016 09:51:23, Vilter, Run Hours: 0).

Figure 6-14. Compressor Control Screen - Control Mode (Oil Control for No Oil Pump)

### Stop Load and Force Unload

The stop load and force unload feature's primary purpose is to attempt to prevent the compressor from tripping off due to a particular instrument reading. For example, if the suction pressure drops too low, the compressor will trip off for safety reasons. However, the stop load & force unload algorithm recognizes a potential trip and either stops the compressor from loading up or even unloads the compressor to prevent the trip.

#### Stop load:

- When this value is reached, the capacity slide will not advance in any condition.

#### Force Unload:

- When this value is reached, the capacity slide position will decrease until the variable reading is below this value.

#### High Motor Amps:

- The motor current values for stop load and force unload.

#### High Discharge Pressure:

- Discharge pressure value for stop load and force unload.

#### Low Suction Pressure:

- Suction pressure values for stop load and force unload

#### High Discharge Superheat:

- Discharge temperature superheat values for stop load and force unload. This is only used for Cool Compression.

## Section 6 • Compressor Control

The screenshot displays the Compressor Control interface. At the top, it shows 'Suction Pressure 1', 'Stopped' status, and '21.1 Psig Δ'. The main 'Slide Valve Control' panel includes two setpoints (Setpoint 1 and Setpoint 2) with 'Stop Load' and 'Force Unload' values for High Motor Amps, High Discharge Pressure, and Low Suction Pressure. It also features 'Slide Valve Setpoint' for Economizer Port 1, Economizer Port 2, and Hot Gas Bypass, along with 'Slide %' and 'State Below Setpoint' (N.O. or N.C.) options. A 'Volume Slide Adjustment %' is set to 0%, and 'Capacity Range' is from 0.0% to 100.0% with a 'Soft Load %' of 75%. On the right, a 'Capacity Slide' is at 0.9% and a 'Volume Slide' is at 3.3%. A sidebar contains buttons for 'Stop', 'Remote Lock Out', 'Alarm Reset', and 'Unit Start'. The bottom right shows system parameters: Suction Press Control (Setpoint 20.0 Psig), Suction (Press 41.1 Psig, Temp 12.3 °F), Discharge (Press 26.8 Psig, Temp 67.6 °F), Discharge : Suction Press Ratio 0.7, Oil (Press Diff 351.4 Psig, Filter Diff -269.5 Psig, Inj Temp 113.1 °F, Sep Temp 124.7 °F), and Motor (Amperage 0.0 Amps). The bottom navigation bar includes 'Maintenance', 'User Access', 'Log off', 'Help', and status messages: 'No Scheduled Maintenance' and 'No Alarm/Trips Present'. User information shows 'User admin', '04/21/2016 06:02:06', and 'Run Hours 0'.

Figure 6-15. Compressor Control Screen - Stop Load, Force Unload and Slide Valve Control

### Capacity Slide Triggered Outputs

The Vision 20/20 offers two digital outputs that can be triggered at a specified capacity slide position. By default, the outputs are preselected for the economizer and the hot gas bypass. However, these preselected outputs are customizable by the operator, see Figure 6-15.

Slide Valve Setpoint:

- Operator editable labels for the each output. Only the Economizer Port 2 label is non-editable.

Slide %:

- Indicates the capacity slide position where the digital output is triggered.

State Below Setpoint:

- Defines the state of the digital output when the slide position is below the “Slide %” setpoint. The operator can choose between “N.O.” or “N.C.”. This setpoint

is not available for the Economizer Port 2, so the Economizer Port 2 follows the setpoint of Economizer Port 1.

Active:

- Check box to enable the digital output. There is no check box to enable the Economizer Port 2 digital output. The economizer Port 2 digital output is enabled when the compressor type selected from the configuration screen is “VSM7” and the Economizer Port 1 digital output is enabled.

## Section 6 • Compressor Control

---

### Volume Slide Position Offset

These setpoints offer the ability to alter the Volume position table to take advantage of potential energy savings. Since the volume position is a function of the capacity position, the offset to the volume is based on the position of the capacity slide. The volume offset can be applied to the entire capacity slide range or just a portion using the Capacity Range minimum and maximum setpoints.

Volume Slide Adjustment %:

- The value in percentage of the volume slide offset.

Capacity Range:

- Defines the range where the volume position slide offset will be applied.

### Soft Load

This setpoint is used to slow the loading of the compressor. In some refrigeration systems, a loading compressor can have dramatic effects on the system parameters. This setpoint allows an operator to reduce the continuous load pulse as defined in the proportional control section to a percent duty cycle.

Soft load %:

- Defines the duty cycle of the continuous load pulse. At 100%, the continuous pulse will truly be continuous. At 50%, the continuous pulse would be reduced to half time on and half time off in the time interval defined in the proportional control section.

### Liquid Injection

The setpoints in this section are to control the behavior of the liquid refrigerant injected into the compressor for oil cooling purposes. The liquid injection solenoid control is based off the discharge temperature whether the compressor uses just an injection solenoid or a motorized valve in conjunction with the solenoid, see Figure 6-16.

Liquid Injection Solenoid Control ONLY

- When using only the liquid injection solenoid, the solenoid is activated once the value of discharge temperature meets or exceeds the value of “Liquid Inj. Setpoint” and the value of the oil separator temperature meets or exceeds the value of “Oil Sep. Temp. Override”. The injection solenoid will deactivate if either setpoints are not met. This will prevent situations where the discharge temperature may rise quickly, but the oil temperature is still very cold. By preventing the liquid injection solenoid from turning on at this point, the oil separator will not be subjected to additional liquid refrigerant that would cool the oil even further.

Liquid Injection Control using a 4-20mA motorized valve:

- When a motorized valve is used to control the amount of liquid being injected into the compressor the previously mentioned setpoints have a slightly different function. The Oil Sep. Temp. Override is still used in controlling the injection solenoid, however, the Liquid Inj. Setpoint is now used as the target temperature for the PID Algorithm that controls the position of the motorized valve. The algorithm compares the actual discharge temperature against the Liquid Inj. Setpoint. The difference between these is the error. The PID algorithm tries to drive the error to “zero” by moving the positioning valve to allow more or less liquid refrigerant to be injected into the compressor.
- A PID algorithm can be notoriously hard to tune. As a result the Vission 20/20 offers a couple of additional features to help control wild fluctuations in oil temperatures that could result in the compressor tripping off. The operator can choose to enable the minimum value position that automatically sets the liquid injection motorized valve to the specified value whenever the discharge temperature has fallen below the Liquid inj. Setpoint. This feature nearly eliminates the overshoot of the PID in the downward direction and reduces the chance of the compressor tripping off due to low oil temperature. The operator can also choose to use an average of the discharge temperature and the oil manifold temperature as the control variable. The discharge temperature can vary quite drastically forcing the PID algorithm to drastically adjust the motorized

## Section 6 • Compressor Control

value. By averaging the more stable oil manifold temperature and discharge temperature, the control variable stabilizes and the PID is more easily tuned.

Please note that as stated above, PID algorithms can be difficult to tune and there is no one set of PID values that will work. The work required for a compressor to meet the requirement of its installation vary greatly and therefore the amount of heat transferred to the oil varies just as greatly. We recommend the operator consult PID tuning guides available from many different sources before attempting to tune this PID.

Liquid Inj. Setpoint:

- Setpoint at which the liquid solenoid will activate if in solenoid control or if the setting for the control variable for the PID is in liquid motorized valve control.

Oil Sep. Temp. Override:

- Defines the temperature the oil must reach before the liquid injection solenoid is allowed to be activated.

P = Proportional (Gain):

- Used to adjust the positioning valve in direct proportion to the difference between the control setpoint

and the discharge temperature ( $SP - DT = \text{error}$ ). The proportional term is a unitless quantity and is used for coarse adjustment. This setpoint should be set to the lowest value that gives adequate response to the control system. Increasing the proportional setting increases the control system's sensitivity to small discharge temperature fluctuations and the tendency to hunt.

I = Integral (reset):

- This parameter integrates the error over time, to account for a small error that has persisted for a long time. This quantity is used for fine adjustment. This setpoint is used to smooth out discharge temperature variations. This setpoint should be set high enough to prevent hunting but not too high or it will cause control system overshoot.

D = Derivative (rate):

- This parameter accounts for how fast the error is changing, positively or negatively.

Minimum Valve Open %:

- When enabled, this is the valve position used whenever the control variable drops below Liquid inj. Setpoint

The screenshot displays the Compressor Control interface. At the top, it shows 'Suction Pressure 1' in green, 'Auto' in green, and '15.2 Psig Δ' in green. The main control area is titled 'Liquid Injection' and includes fields for 'Liquid Inj. Setpoint' (135.0 °F) and 'Oil Sep. Temp. Override' (100.0 °F). Below this is the 'Motorized Valve Control' section with PID parameters: P (25.0), I (1.0), and D (4.0). There are checkboxes for 'Avg. With Oil Manifold Temperature' and 'Minimum Valve Open %' (42.5%). A 'Dual Liquid Injection' section is also present with various pressure and temperature settings. On the right side, there are 'Capacity Slide' (37.6%) and 'Volume Slide' (57.9%) controls, along with buttons for 'Stop', 'Remote Lock Out', 'Alarm Reset', and 'Unit Start'. The bottom right corner shows 'Suction Press Control' (Setpoint 20.0 Psig) and 'Suction' (Press 35.2 Psig, Temp 25.5 °F) and 'Discharge' (Press 94.4 Psig, Temp 54.8 °F) data. A 'Discharge : Suction Press Ratio' of 2.2 is also shown. The bottom status bar includes 'Maintenance', 'User Access', 'Log off', and 'Help' buttons, along with 'No Scheduled Maintenance' and 'No Alarm/Trips Present' messages. System information at the bottom right includes 'User: admin', 'Date: 04/06/2016', 'Time: 06:07:13', 'Run Hours: 0', and 'Motor Amperage: 1.3 Amps'.

Figure 6-16. Compressor Control Screen - Liquid Injection & Dual Liquid Injection Control



## Section 6 • Compressor Control

---

1. Use only if the compressor is tripping off for low oil temperature due to large overshoots and all other tuning methods have failed.

Avg. with Oil Manifold Temperature:

- When enabled, averages the Oil manifold temperature and the discharge temperature. This creates a more stable control variable and should result in more stable control.
- This selection should be determined by the operator through testing.

### NOTE

For more information on oil cooling setups, see Appendix B.

## Dual Liquid Injection

The Dual Liquid Injection controls the Liquid Injection # 2 digital output. The Liquid Injection # 2 digital output is controlled depending on Liquid Pressure and Slide % value. Refer to Figure 6-16 for Dual Liquid Injection Setpoints.

Dual Liquid Injection:

- This check-box is used to Enable the Dual Liquid Injection Feature. The Enable/Disable functionality of this box depends on Selected Compressor Type and Model in the Configuration Screen.

Valve Loss:

- This Setpoint defines the Valve Train Loss for the Dual Liquid Injection Feature.

Safety Loss:

- This Setpoint defines the Safety Loss for the Dual Liquid Injection Feature.

Slide %:

- This Setpoint defines Slide % Value. The Liquid Injection # 2 digital output depends on this setpoint.

Liquid Pressure:

- This is the measured value at available Dual Liquid Injection port.

Switch Pressure:

- This value is used to control the Liquid Injection # 2 digital output. When the Liquid Pressure is less than the Switch pressure then Liquid Injection # 2 digital output will be Turned OFF. When the Liquid Pressure is greater than Switch Pressure & Slide Position is greater than the Slide % Setpoint Liquid Injection # 2 digital output will be Turned ON.

Orifice Loss:

- This is the measured value for liquid port orifice Loss.

Port Selection:

- User can select the “Low-Medium”, “Low-High” or “Medium-High” port option. This selection depends on Compressor Type & Compressor Model.



### Liquid Injection Outlet Port Direction

The toggle switch (S1) on the circuit board is used to select which port is the preferred “Pre Start-Up” outlet position. The valve shall be at the lowest-pressure outlet position at “Pre Start-Up” (i.e. low or medium, depending on tubing positions).

In the “SIG CCW” position, the actuator moves CCW when the signal is energized during operation (based on the switch pressure), until it reaches the limit - this makes the 3 o'clock port the outlet port (Figure 6-17, right image). Conversely, the other switch position, “SIG CW,” makes the 12 o'clock port the outlet when the signal is

energized during operation (Figure 6-17, left image).

Each rotor diameter has a different port configuration on the compressor housing.

For 205mm: there are only medium and low-ratio ports, both of which are located on both top and bottom of the housing.

For 240mm-350mm: low ports are located on the top and bottom of the compressor, the medium port is on the top, and the high port is on the bottom.

For 401mm: all three ports are located on both the top and bottom of the housing.

**Table 6-1. Compressor Size and Liquid Injection Outlet Port Direction**

Compressor Size	Tubing Lines	Toggle Switch	Outlet Port (de-energized)
VSM152-401 (205mm)	Low-Medium	SIG CW	3 o'clock
	Low-High	N/A	N/A
	Medium-High	N/A	N/A
VSM501-701 (240mm)	Low-Medium	SIG CW	3 o'clock
VSS751-901 (280mm)			
VSS1051-1301 (310mm)	Low-High	SIG CCW	12 o'clock
VSS1551-2101 (350mm)	Medium-High	SIG CCW	12 o'clock
VSS2401-3001 (401mm)	Low-Medium	Incomplete	Incomplete
	Low-High	Incomplete	Incomplete
	Medium-High	Incomplete	Incomplete

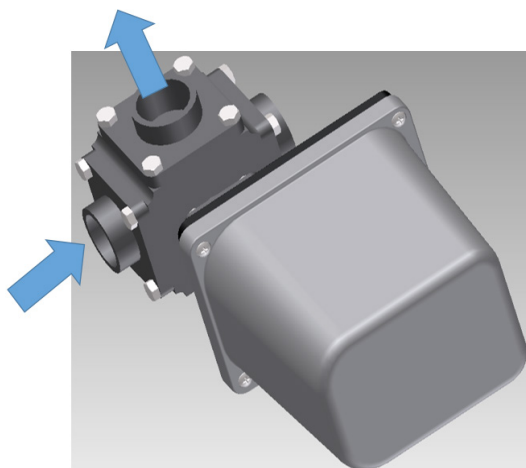

12 o'clock outlet port

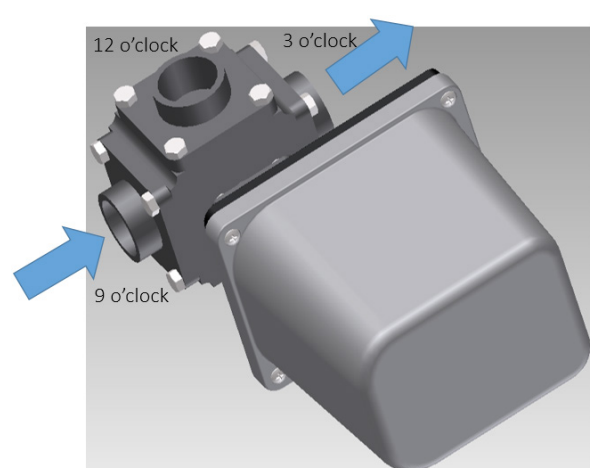

3 o'clock outlet port

**Figure 6-17. Port Inlet and Outlet Flow Directions**

## Section 6 • Compressor Control

### VI Control - Twin Screw

This is the page where VI Control settings can be configured. This feature is only available for Twin Screw Compressors. There are three types of VI Control methods which can be configured as follows:

#### Fixed VI

- If this method is selected then there will be no volume control for Twin Screw compressors.

The screenshot displays the 'VI Control' interface for a Twin Screw compressor. The main control area is titled 'VI Control' and includes the following settings:

- VI Control Method:** Fixed VI (selected), Continuous VI, Step VI.
- Time Interval:** 20 sec
- Continuous VI Settings:**
  - Minimum VI: 2.2
  - Maximum VI: 5.0
  - Deadband: 0.4
- Step VI Settings:**
  - Step 1: 2.2
  - Step 2: 3.5
  - Step 3: 5.0

On the right side, there is a 'Capacity Slide' set to 0.0% with 'Stop', 'Remote Lock Out', 'Alarm Reset', and 'Unit Start' buttons. Below this is a 'Suction Press Control' section showing a 'Setpoint' of 20.0 Psig. Further down, 'Suction' and 'Discharge' parameters are listed:

Suction	
Press	26.6 Psig
Temp	55.0 °F

Discharge	
Press	124.2 Psig
Temp	71.5 °F

The 'Discharge : Suction' section shows a 'Press Ratio' of 3.4. The 'Oil' section displays:

Press Diff	46.2 Psig
Filter Diff	9.5 Psig
Inj Temp	115.1 °F
Sep Temp	110.3 °F

The 'Motor' section shows 'Amperage' at 0.0 Amps. At the bottom, there are navigation buttons (Maintenance, User Access, Log off, Help), a 'Panel 1' indicator, and system status information: 'No Scheduled Maintenance', 'No Alarm/Trips Present', 'User: admin', 'Date/Time: 11/07/2014 11:53:40', and 'Run Hours: 0'.

Figure 6-18. Compressor Control Screen - Fixed VI (Twin Screw)

## Section 6 • Compressor Control

### Continuous VI

- If this method is selected then the volume slide valve will be controlled according to the current volume ratio.

### Minimum VI

- This setpoint defines the minimum slide position value (0%) for volume slide valve. The default value for Minimum VI is 2.2.

### Maximum VI

- This setpoint defines the maximum slide position value (100%) for volume slide valve. The default value for Maximum VI is 5.0.

### Deadband

- This setpoint defines the deadband for the calculation of the volume slide position. Volume will not be changed till the Volume Ratio changes by this amount. The default value for Deadband is 0.4.

### Time Interval

- This setpoint specifies the time interval after which the volume ratio is calculated to determine the position of the volume slide valve.

The screenshot displays the 'VI Control' interface for a Twin Screw compressor. The main control area is titled 'VI Control' and includes the following sections:

- VI Control Method:** Radio buttons for 'Fixed VI', 'Continuous VI' (selected), and 'Step VI'.
- Time Interval:** A text input field set to '20 sec'.
- Continuous VI:** Input fields for 'Minimum VI' (2.2), 'Maximum VI' (5.0), and 'Deadband' (0.4).
- Step VI:** Input fields for 'Step 1' (2.2), 'Step 2' (3.5), and 'Step 3' (5.0).

On the right side of the screen, there are several status and control panels:

- Capacity Slide:** Shows '0.0 %' with minus and plus buttons, and a red 'Stop' button.
- Volume Slide:** Shows '0.0 %' with minus and plus buttons, and a yellow 'Alarm Reset' button.
- Suction Press Control:** Shows 'Setpoint 20.0 Psig'.
- Suction:** Shows 'Press 26.5 Psig' and 'Temp 55.0 °F'.
- Discharge:** Shows 'Press 124.2 Psig' and 'Temp 71.2 °F'.
- Discharge : Suction:** Shows 'Press Ratio 3.4'.
- Oil:** Shows 'Press Diff 46.1 Psig', 'Filter Diff 9.7 Psig', 'Inj Temp 115.3 °F', and 'Sep Temp 110.1 °F'.
- Motor:** Shows 'Amperage 0.0 Amps'.

At the bottom of the screen, there is a navigation bar with page numbers 1-8 (page 8 is selected) and a 'Menu' button. Below this is a status bar with buttons for 'Maintenance', 'User Access', 'Log off', and 'Help'. The status bar also displays 'Panel 1', 'User admin', '11/07/2014 11:54:21', and 'Run Hours 0'. Two status messages are shown: 'No Scheduled Maintenance' and 'No Alarm/Trips Present'.

Figure 6-19. Compressor Control Screen - Continuous VI (Twin Screw)

## Section 6 • Compressor Control

### Step VI

- If this method is selected then the VI Digital Outputs will be controlled according to the current volume ratio.

#### Step 1

- This setpoint defines the minimum step value for Step VI control. The default value for Step 1 is 2.2. This value is used for the calculation of Step 1 & Step 2 Digital Outputs. When Volume Ratio is less than average of Step 1 & Step 2, Low VI Output will be ON and High VI Digital Output will be OFF.

#### Step 2

- This setpoint defines the intermediate step value for Step VI control. The default value for Step 2 is 3.5. This value is used for calculation of Step 2 & Step 3

Digital Outputs. When Volume Ratio is greater than average of Step 1 & Step 2 and also less than average of Step 2 & Step 3, Low VI Digital Output will be OFF and High VI Digital Output will be ON.

#### Step 3

- This setpoint defines the maximum step value for Step VI control. The default value for Step 3 is 5.0. This value is used for calculation of Step 2 & Step 3 Digital Outputs. When Volume Ratio is greater than average of Step 2 & Step 3, both Low VI and High VI Digital Outputs will be OFF.

#### Time Interval

- This setpoint specifies the time interval after which the volume ratio is calculated to determine the current step in Step VI Control.

**Table 6-2. Step VI Digital Outputs depending on Volume Ratio**

Volume Ratio	LOW VI DIGITAL OUTPUT	HIGH IV DIGITAL OUTPUT
< Average (Step1 & Step2)	ON	OFF
> Average (Step1 & Step2) and < Average (Step2 & Step3)	OFF	ON
> Average (Step2 & Step3)	OFF	OFF

The screenshot shows the 'VI Control' interface for a Twin Screw compressor. The main control area includes:

- VI Control Method:** Fixed VI, Continuous VI, and Step VI (selected).
- Time Interval:** 20 sec.
- Continuous VI:** Minimum VI (2.2), Maximum VI (5.0), Deadband (0.4).
- Step VI:** Step 1 (2.2), Step 2 (3.5), Step 3 (5.0).

On the right side, there is a 'Capacity Slide' set to 0.0% and several control buttons: Stop (red), Remote Lock Out (yellow), Alarm Reset (yellow), and Unit Start (green). Below these are status panels for Suction Press Control (Setpoint 20.0 Psig), Suction (Press 26.5 Psig, Temp 55.0 °F), Discharge (Press 124.0 Psig, Temp 71.5 °F), Discharge : Suction Press Ratio (3.4), Oil (Press Diff 46.2 Psig, Filter Diff 9.5 Psig, Inj Temp 115.3 °F, Sep Temp 110.3 °F), and Motor (Amperage 0.0 Amps).

At the bottom, there are navigation buttons (Maintenance, User Access, Log off, Help), a 'Panel 1' label, and system status information: No Scheduled Maintenance, No Alarm/Trips Present, User admin, Date 11/07/2014, Time 11:52:29, and Run Hours 0.

**Figure 6-20. Compressor Control Screen - Step VI (Twin Screw)**

## Section 7 • Alarms and Trips

### Overview

The Alarms and Trips screen allows the operator to view and adjust settings for compressor safety and alarm settings.

### Warnings

The Vision 20/20 uses Warnings as a way to notify the operator of parameters that may inhibit the compressor when started. Warnings are monitored only when compressor is not running. Unless otherwise specified, Warnings use alarm setpoints for detection and message generation.

All warning messages present can be seen collectively in a pop-up window. This pop-up is displayed when a warning condition is present and the bottom status bar used for displaying warnings is pressed.

Warnings are always displayed as an orange banner on the bottom status bar.

### Inhibits

The Vision 20/20 uses several start Inhibits to prevent the compressor from starting to protect the compressor and the refrigeration system. Inhibits are only active during Pre-Start condition. While starting the compressor, the Inhibits are checked first before the oil pump is started or the motor is started. Failed starts due to an Inhibit do not count toward any of the anti-recycle timers including hot starts. Unless otherwise specified, Inhibits use Alarm Setpoints to trigger an aborted start and message.

Inhibits are always displayed as a red banner.

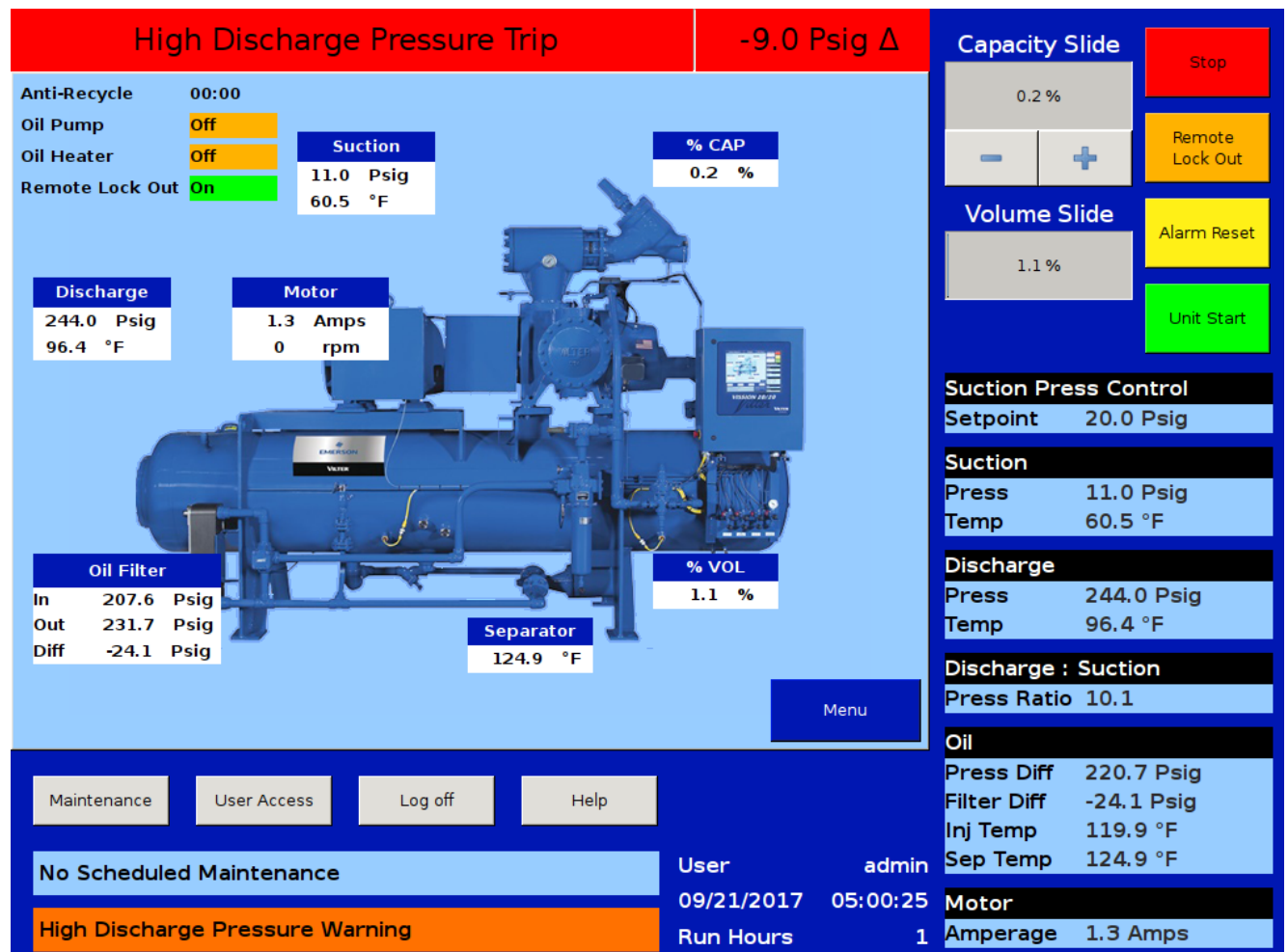

Figure 7-1 - Typical Status Banner Message Display

## Section 7 • Alarms and Trips

### Alarms

Vision 20/20 uses Alarms as a way to notify the operator of running parameters that if left unchecked could result in the compressor shutting down due to a trip. Alarms are only active when compressor is running.

Alarms are always displayed as yellow banners on the top and bottom status bars.

### Trips

Trips are the conditions that exceed the safety limits of the compressor or refrigeration system and stop the compressor. Trips are only active when compressor is running.

Trips are always displayed as a red banners on the top and bottom status bars.

### Freeze Screens

Trips also trigger the input/output screen to take a snapshot of all input and output values as Freeze 1 screen. The five most recent Freeze screens are saved. The Freeze screens are available as left side tabs in the input/output screens and are very useful as a troubleshooting tool for the operator.

Refer to Section 17 / Figure 17-7 for a typical Freeze Data (Trip) Screen.

### Logging – Event List

All Inhibit, Alarm and Trip conditions are logged in the Event List to provide an operational history for the operator. The Event List is accessible from the menu screen.

### Setpoints

All possible Warning, Inhibit, Alarm and Trip messages are listed here alphabetically with relevant notes.

	Alarm	Trip
<b>Low Suction Pressure</b>		
Setpoint No. 1	3.1 "Hg	4.1 "Hg
Setpoint No. 2	1.0 "Hg	2.0 "Hg
<b>High Discharge Pressure</b>		
Setpoint No. 1	210.0 Psig	220.0 Psig
Setpoint No. 2	220.0 Psig	230.0 Psig
<b>High Process Temperature</b>		
Setpoint No. 1	100.0 °F	None
Setpoint No. 2	120.0 °F	None
<b>Low Process Temperature</b>		
Setpoint No. 1	-50.0 °F	-55.0 °F
Setpoint No. 2	-40.0 °F	-45.0 °F

Suction Press Control	
Setpoint	20.0 Psig
Suction	
Press	26.7 Psig
Temp	55.5 °F
Discharge	
Press	124.5 Psig
Temp	71.9 °F
Discharge : Suction	
Press Ratio	3.4
Oil	
Press Diff	143.4 Psig
Filter Diff	9.8 Psig
Inj Temp	115.6 °F
Sep Temp	110.8 °F
Motor	
Amperage	0.0 Amps

Page 1 | Menu

Maintenance | User Access | Log off | Help

No Scheduled Maintenance | User: admin | 11/07/2014 09:46:17 | Run Hours: 0

No Alarm/Trips Present

Figure 7-2. Alarms and Trips Screen - Page 1 (Process Temperature)

# Section 7 • Alarms and Trips

Process Control 1
Stopped
122.9 Psig  $\Delta$

	Alarm	Trip
<b>Low Suction Pressure</b>		
Setpoint No. 1	3.1 "Hg	4.1 "Hg
Setpoint No. 2	1.0 "Hg	2.0 "Hg
<b>High Discharge Pressure</b>		
Setpoint No. 1	210.0 Psig	220.0 Psig
Setpoint No. 2	220.0 Psig	230.0 Psig
<b>Low Process Pressure</b>		
Setpoint No. 1	3.1 "Hg	4.1 "Hg
Setpoint No. 2	1.0 "Hg	2.0 "Hg
<b>High Process Pressure</b>		
Setpoint No. 1	210.0 Psig	220.0 Psig
Setpoint No. 2	220.0 Psig	230.0 Psig

**Capacity Slide**

0.1 %

-    +

**Volume Slide**

0.0 %

-    +

Stop

Remote Lock Out

Alarm Reset

Unit Start

Page 1 2 3
Menu

Maintenance
User Access
Log off
Help

No Scheduled Maintenance

No Alarm/Trips Present

User admin

07/15/2015 11:44:32

Run Hours 0

**Process Press Control**

Setpoint 30.0 Psig

---

**Suction**

Press 43.5 Psig

Temp 26.5 °F

---

**Discharge**

Press 177.7 Psig

Temp -3.9 °F

---

**Discharge : Suction**

Press Ratio 3.3

---

**Oil**

Press Diff 118.5 Psig

Filter Diff 6.2 Psig

Inj Temp 78.8 °F

Sep Temp 191.9 °F

---

**Motor**

Amperage 0.0 Amps

Figure 7-3. Alarms and Trips Screen - Page 1 (Process Pressure)

# Section 7 • Alarms and Trips

Suction Pressure 1
Stopped
6.7 Psig Δ

	Alarm	Trip
Low Suction Temperature	-45.0 °F	-50.0 °F
High Discharge Temperature	205.0 °F	210.0 °F
Low Oil Separator Start Temp	75.0 °F	70.0 °F
Low Oil Separator Run Temp	105.0 °F	100.0 °F
Low Oil Injection Temp	95.0 °F	90.0 °F
High Oil Injection Temp	145.0 °F	150.0 °F
High Disch. Superheat Start Temp		65.0 °F
High Disch. Superheat Run Temp	22.0 °F	25.0 °F
High Disch. Superheat Start Offset Temp		5.0 °F
Low Suction Superheat Temp	5.0 °F	3.0 °F

Page 1 2 3

Menu

Maintenance    User Access    Log off    Help

**No Scheduled Maintenance**

**No Alarm/Trips Present**

User                    admin

11/07/2014    09:49:12

Run Hours            0

**Capacity Slide**

0.1 %

[-]    [+]

**Volume Slide**

2.3 %

Stop

Remote Lock Out

Alarm Reset

Unit Start

**Suction Press Control**

Setpoint    20.0 Psig

---

**Suction**

Press        26.7 Psig

Temp        55.5 °F

---

**Discharge**

Press        124.4 Psig

Temp        71.7 °F

---

**Discharge : Suction**

Press Ratio 3.4

---

**Oil**

Press Diff    143.6 Psig

Filter Diff    9.7 Psig

Inj Temp      115.3 °F

Sep Temp     110.5 °F

---

**Motor**

Amperage    0.0 Amps

Figure 7-4. Alarms and Trips Screen - Page 2



# Section 7 • Alarms and Trips

Suction Pressure 1
Stopped
-11.0 Psig Δ

	Alarm	Trip
Low Suction Temperature	-45.0 °F	-50.0 °F
High Discharge Temperature	205.0 °F	210.0 °F
Low Oil Separator Start Temp	75.0 °F	70.0 °F
Low Oil Separator Run Temp	10.0 °F	5.0 °F
High Oil Separator Temp	105.0 °F	110.0 °F
Low Oil Injection Temp	95.0 °F	90.0 °F
High Oil Injection Temp	145.0 °F	150.0 °F
High Disch. Superheat Start Temp		65.0 °F
High Disch. Superheat Run Temp	22.0 °F	25.0 °F
High Disch. Superheat Start Offset Temp		5.0 °F
Low Suction Superheat Temp	5.0 °F	3.0 °F

**Capacity Slide**  
0.2 %

[-] [+]

**Volume Slide**  
0.0 %

[Stop]

[Remote Lock Out]

[Alarm Reset]

[Unit Start]

---

**Suction Press Control**  
Setpoint 20.0 Psig

**Suction**  
Press 9.0 Psig  
Temp 60.3 °F

**Discharge**  
Press 115.5 Psig  
Temp -45.5 °F  
Superheat -115.7 °F

**Discharge : Suction**  
Press Ratio 5,5

**Oil**  
Press Diff 169.3 Psig  
Filter Diff -168.5 Psig  
Inj Temp 108.9 °F  
Sep Temp 127.2 °F

**Motor**  
Amperage 1.3 Amps

Page 1 2 3
Menu

Maintenance User Access Log off Help

No Scheduled Maintenance

No Alarm/Trips Present

User admin

07/31/2017 01:08:31

Run Hours 0

Figure 7-5. Alarms and Trips Screen - Page 2 Cool Compression

# Section 7 • Alarms and Trips

Suction Pressure 1
Stopped
126.8 Psig Δ

	Alarm	Trip
Prelube Oil Pressure	4.0 Psig	2.0 Psig
Run Oil Pressure	38.0 Psig	35.0 Psig
High Filter Diff Start Pressure	45.0 Psig	50.0 Psig
High Filter Diff Run Pressure	12.0 Psig	15.0 Psig
High Motor Amps	15.0 Amps	15.0 Amps
Oil Over Pressure		100.0 Psig

**Capacity Slide**  
2.2 %

-    +

**Volume Slide**  
2.1 %

-    +

Stop

Remote Lock Out

Alarm Reset

Unit Start

**Suction Press Control**  
Setpoint 20.0 Psig

**Suction**  
Press 146.8 Psig  
Temp 114.0 °F

**Discharge**  
Press 59.8 Psig  
Temp 52.7 °F

**Discharge : Suction**  
Press Ratio 0.5

**Oil**  
Press Diff -10.6 Psig  
Filter Diff 39.4 Psig  
Inj Temp 120.8 °F  
Sep Temp 76.5 °F

**Motor**  
Amperage 0.0 Amps

Page 1 2 **3**

Maintenance User Access Log off Help

No Scheduled Maintenance

No Alarm/Trips Present

User admin

06/10/2016 06:17:50

Run Hours 0

Menu

Figure 7-6. Alarms and Trips Screen - Page 3

## Section 7 • Alarms and Trips

Suction Pressure 1
Stopped
10.4 Psig Δ

	Alarm	Trip
Prelube Oil Pressure	4.0 Psig	2.0 Psig
Run Oil Pressure	38.0 Psig	35.0 Psig
High Filter Diff Start Pressure	45.0 Psig	50.0 Psig
High Filter Diff Run Pressure	12.0 Psig	15.0 Psig
High Motor Amps	15.0 Amps	15.0 Amps
SOI Low Oil Pressure	8.0 Psig	6.0 Psig
SOI Low Pressure Ratio	2.6	2.4

**Capacity Slide**  
0.0 %

[-] [+]

**Volume Slide**  
0.0 %

[-] [+]

**Stop**

**Remote Lock Out**

**Alarm Reset**

**Unit Start**

Page 1 2 **3**

Maintenance User Access Log off Help

**No Scheduled Maintenance**

**No Alarm/Trips Present**

**Menu**

User admin

09/29/2014 16:03:43

Run Hours 0

**Suction Press Control**  
Setpoint 20.0 Psig

**Suction**  
Press 30.4 Psig  
Temp 53.6 °F

**Discharge**  
Press 109.3 Psig  
Temp 68.5 °F

**Discharge : Suction**  
Press Ratio 2.7

**Oil**  
Press Diff 139.4 Psig  
Filter Diff 10.2 Psig  
Inj Temp 114.2 °F  
Sep Temp 111.0 °F

**Motor**  
Amperage 0.0 Amps

Figure 7-7. Alarms and Trips Screen - Page 3 (SOI Solenoid)

# Section 7 • Alarms and Trips

Suction Pressure 1
Stopped
3.4 Psig Δ

	Alarm	Trip
Prelube Oil Pressure	4.0 Psig	2.0 Psig
Run Oil Pressure	38.0 Psig	35.0 Psig
High Filter Diff Start Pressure	45.0 Psig	50.0 Psig
High Filter Diff Run Pressure	12.0 Psig	15.0 Psig
High Motor Amps	15.0 Amps	15.0 Amps
Start Oil Pressure Stage 1 Pressure		3.0 Psig
Start Oil Pressure Stage 2 Pressure		8.0 Psig

**Capacity Slide**  
2.6 %

-    +

**Volume Slide**  
3.3 %

-    +

Stop

Remote Lock Out

Alarm Reset

Unit Start

**Suction Press Control**  
Setpoint 20.0 Psig

**Suction**  
Press 23.4 Psig  
Temp 26.5 °F

**Discharge**  
Press 97.6 Psig  
Temp 55.7 °F

**Discharge : Suction**  
Press Ratio 2.9

**Oil**  
Press Diff 89.8 Psig  
Filter Diff 9.1 Psig  
Inj Temp 111.7 °F  
Sep Temp 122.2 °F

**Motor**  
Amperage 0.0 Amps

Page 1 2 **3**

Maintenance User Access Log off Help

**No Scheduled Maintenance**

**No Alarm/Trips Present**

User admin

04/05/2016 07:42:35

Run Hours 0

Figure 7-8. Alarms and Trips Screen - Page 3 (No Oil Pump)

# Section 7 • Alarms and Trips

Suction Pressure 1
Stopped
26.2 Psig  $\Delta$

	Alarm	Trip
Prelube Oil Pressure	4.0 Psig	2.0 Psig
Run Oil Pressure	38.0 Psig	35.0 Psig
High Filter Diff Start Pressure	45.0 Psig	50.0 Psig
High Filter Diff Run Pressure	12.0 Psig	15.0 Psig
High Motor Amps	15.0 Amps	15.0 Amps
Low Run Pressure Ratio	1.6	1.4

**Capacity Slide**

0.0 %

-    +

---

**Volume Slide**

3.3 %

-    +

Stop

Remote Lock Out

Alarm Reset

Unit Start

---

**Suction Press Control**

Setpoint 20.0 Psig

---

**Suction**

Press 46.2 Psig

Temp 114.2 °F

---

**Discharge**

Press 30.0 "Hg

Temp -90.3 °F

Superheat 39.4 °F

---

**Discharge : Suction**

Press Ratio -0.4

---

**Oil**

Press Diff 106.4 Psig

Filter Diff -4.4 Psig

Inj Temp 121.3 °F

Sep Temp 77.0 °F

---

**Motor**

Amperage 0.0 Amps

Page 1 2 3
Menu

Maintenance    User Access    Log off    Help

No Scheduled Maintenance

No Alarm/Trips Present

User admin

06/16/2016 06:52:22

Run Hours 0

Figure 7-9. Alarms and Trips Screen - Page 3 (Cool Compression)

## Section 7 • Alarms and Trips

Warnings	Inhibits	Alarms	Trips
Not Running (Idle)	Pre-Start	Running	Running
<b>Add Oil to the Middle Sight Glass</b> Only when Cool Compression is enabled.			
		Add Oil to the Middle Sight Glass	
		Oil Level < Open Low Oil Level Switch	
<b>Analog AUX In 1-16</b> This message will appear when the Analog Aux in 1-16 exceeds / falls below the safety setting of the High / Low Alarm Setpoint.			
Analog Aux in 1-16 Warning	Analog Aux in 1-16 Inhibit	Analog Aux in 1-16 Alarm	Analog Aux in 1-16 Trip
Analog AUX In 1-16 > or < Analog AUX In 1-16 Safety Setting	Analog AUX In 1-16 > or < Analog AUX In 1-16 Safety Setting	Analog AUX In 1-16 > or < Analog AUX In 1-16 Safety Setting	Analog AUX In 1-16 > or < Analog AUX In 1-16 Safety Setting
<b>Capacity Position Trip</b> This message will appear if the condition exists following any shutdown.			
			Capacity Position Trip
			Capacity Slides failing to unload < 5% during Capacity Unload Cycle
<b>Compressor Interlock Trip</b> Compressor Interlock Trip message will appear if the Motor Auxiliary contact fails to close before the Compressor Starter Auxiliary Contact Bypass timer times out. Refer to the wiring diagram provided with unit.			
	Compressor Interlock Inhibit		Compressor Interlock Trip
	Motor Auxiliary Contact Fails to Close when Compressor is starting		Motor Auxiliary Contact Fails to Close before Compressor Starter Auxiliary Contact Bypass Timer times out
<b>Digital AUX In 1-8</b> This message will appear when the Digital Aux in 1-8 is Active High / Low.			
Digital Aux in 1-8 Warning	Digital Aux in 1-8 Inhibit	Digital Aux in 1-8 Alarm	Digital Aux in 1-8 Trip
Digital AUX In 1-8 > or < Digital AUX In 1-8 Active High / Low	Digital AUX In 1-8 > or < Digital AUX In 1-8 Active High / Low	Digital AUX In 1-8 > or < Digital AUX In 1-8 Active High / Low	Digital AUX In 1-8 > or < Digital AUX In 1-8 Active High / Low

## Section 7 • Alarms and Trips

Warnings	Inhibits	Alarms	Trips
Not Running (Idle)	Pre-Start	Running	Running
<b>High Discharge Pressure (Discharge Pressure)</b> This message will appear when the Discharge Pressure exceeds the safety setting of the High Discharge Pressure Alarm (or Trip) Setpoint No.1 or No. 2. See Figure 7-3.			
High Discharge Pressure Warning	High Discharge Pressure Inhibit	High Discharge Pressure Alarm	High Discharge Pressure Trip
Discharge Pressure > High Discharge Pressure Alarm Setpoint No. 1 or No. 2	Discharge Pressure > High Discharge Pressure Alarm Setpoint No. 1 or No. 2	Discharge Pressure > High Discharge Pressure Alarm Setpoint No. 1 or No. 2	Discharge Pressure > High Discharge Pressure Trip Setpoint No. 1 or No. 2
<b>Low Discharge Pressure (Discharge Pressure)</b> This is not a user adjustable setpoint. The value is used to test for a failure in the measuring instrument.			
Low Discharge Pressure Warning	Low Discharge Pressure Inhibit		Low Discharge Pressure Trip
Discharge Pressure < -66.5 psig	Discharge Pressure < -66.5 psig		Discharge Pressure < Low Discharge Pressure Trip [-66.5 psig]
<b>Discharge Superheat Temperature</b> These safeties are active when superheat monitor is enabled in the configuration screen. Superheat Temperature depends on Discharge Pressure and Discharge Temperature.			
<b>High Discharge Superheat Start Temp (Discharge Superheat Temperature)</b> This message will appear when the Discharge Superheat Temperature exceeds the safety setting of the High Superheat Start Temp Trip Setpoint. See Figure 7-5.			
High Superheat Temp Warning	High Superheat Temp Inhibit		High Superheat Start Temp Trip
Discharge Superheat Temperature > High Discharge Superheat Start Temperature Trip	Discharge Superheat Temperature > High Discharge Superheat Start Temperature		Discharge Superheat Temperature > High Discharge Superheat Start Temperature Trip
<b>High Discharge Superheat Rise Temp (Discharge Superheat Temperature)</b> This message will appear when the Discharge Superheat Temperature exceeds the safety setting of the High Superheat Start Temp Trip Setpoint. [Starting]After a time delay, (setting of the High Superheat Temperature Safety Changeover timer), this safety is deactivated and the High Superheat Run Temperature alarm and safety Setpoints become active. The trip will be activated if the superheat temperature from start rises above the superheat temperature plus the Setpoint value. See Figure 7-5.			
			High Superheat Rise Temp Trip
			Discharge Superheat Temperature > Discharge Superheat Start Temperature Offset

## Section 7 • Alarms and Trips

Warnings	Inhibits	Alarms	Trips
Not Running (Idle)	Pre-Start	Running	Running
<b>High Discharge Superheat Run Temp (Discharge Superheat Temperature)</b> This message will appear when the Discharge Superheat Temperature exceeds the safety setting of the High Superheat Start Temp Trip Setpoint. [Running]After a time delay, (setting of the High Superheat Temperature Safety Changeover timer), the High Superheat Start Offset Temperature is bypassed and High Superheat Run Temperature alarm and safety setpoints become active. See Figure 7-5.			
		High Superheat Run Temp Alarm	High Superheat Run Temp Trip
		Discharge Superheat Temperature > Discharge Superheat Run Alarm Temperature	Discharge Superheat Temperature > High Discharge Superheat Run Temperature Trip
<b>High Discharge Temp (Discharge Temperature)</b> See Figure 7-5.			
High Discharge Temp Warning	High Discharge Temp Inhibit	High Discharge Temp Alarm	High Discharge Temp Trip
Discharge Temperature > High Discharge Temperature Alarm	Discharge Temperature > High Discharge Temperature Alarm	Discharge Temperature > High Discharge Temperature Alarm	Discharge Temperature > High Discharge Temperature Trip
<b>Low Discharge Temp (Discharge Temperature)</b> This is not a user adjustable setpoint. The value is used to test for a failure in the measuring instrument.			
Low Discharge Temp Warning	Low Discharge Temp Inhibit		Low Discharge Temp Trip
Discharge Temperature < -100 °F	Discharge Temperature < -100 °F		Discharge Temperature < Low Discharge Temperature Trip [-100 °F]
<b>Emergency Shutdown Activated</b>			
			Emergency Shutdown Activated
			Compressor in False Start Condition After Emergency Stop Timer times out
<b>False Start</b>			
			False Start
			Motor Auxiliary Contact Fails to Open
<b>False Start</b>			
			False Start
			Motor Amperage > 20% Maximum Amps



## Section 7 • Alarms and Trips

Warnings	Inhibits	Alarms	Trips
Not Running (Idle)	Pre-Start	Running	Running
<b>Filter Differential Pressure</b> (Oil Filter Inlet Pressure - Oil Manifold Pressure)			
<b>High Filter Differential - Start (Filter Differential Pressure)</b> This safety allows a higher than normal filter differential pressure to exist during the first minute after a compressor starts. This allows time for cold oil that is present in the oil piping and filters to be passed and replaced with warmer oil. After a time delay (setting of the Filter Diff Pressure Safety Changeover timer), this safety is deactivated and the High Filter Differential Pressure-Run alarm and safety setpoints become active. See Figure 7-6.			
High Filter Differential Warning	High Filter Differential Inhibit	High Filter Differential Alarm	High Filter Differential Trip
Filter Differential Pressure > High Filter Differential Start Pressure Alarm	Filter Differential Pressure > High Filter Differential Start Pressure Alarm	Filter Differential Pressure > High Filter Differential Start Pressure Alarm	Filter Differential Pressure > High Filter Differential Start Pressure Trip
<b>High Filter Differential - Run (Filter Differential Pressure)</b> After the Filter Differential Pressure Safety Changeover Timer times out. This safety setpoint is active when the compressor has started and the Filter Diff Pressure Safety Changeover timer has timed out. See Figure 7-6.			
		High Filter Differential Alarm	High Filter Differential Trip
		Filter Differential Pressure > High Filter Differential Run Pressure Alarm	Filter Differential Pressure > High Filter Differential Run Pressure Trip
<b>High Level Shutdown (Level Shutdown)</b> This message will appear when power is removed from the input module during Compressor start. High Level Shutdown switch is wired to the digital input normally closed. Usually connected to a float switch on a vessel containing liquid refrigerant. In case of multiple switches, any open switch will generate a relevant message depending on compressor operating mode.			
High Level Shutdown Warning	High Level Shutdown Inhibit		High Level Shutdown Trip
Level > High Level Shutdown Switch Opens	Power removed from input module during Compressor start		Power removed from input module while compressor is running
<b>Motor Current</b> This safety setpoint is active after the Volume Decrease at Start Timer expires. The timer is not adjustable by the operator. See Figure 7-6.			
		High Motor Current Alarm	High Motor Current Trip
		Motor Current > High Motor Current Alarm	Motor Current > High Motor Amps Trip

## Section 7 • Alarms and Trips

Warnings	Inhibits	Alarms	Trips
Not Running (Idle)	Pre-Start	Running	Running
<b>Low Oil Filter Inlet Pressure (Oil Filter Inlet Pressure)</b> This Safety will be active only when Cool Compression is not enabled. This is not a user adjustable setpoint. The value is used to test for a failure in the measuring instrument.			
Low Oil Filter In Pressure Warning			Low Oil Filter In Pressure Trip
Oil Filter Inlet Pressure < -66.5 psig			Oil Filter Inlet Pressure < Low Oil Filter In Pressure Trip [-66.5 psig]
<b>Low Oil Filter Outlet Pressure (Oil Filter Outlet Pressure)</b> This Safety will be active only when Cool Compression is not enabled. This is not a user adjustable setpoint. The value is used to test for a failure in the measuring instrument.			
Low Oil Filter Out Pressure Warning			Low Oil Filter Out Pressure Trip
Oil Manifold Pressure < -66.5 psig			Oil Filter Inlet Pressure < Low Oil Filter Out Pressure Trip [-66.5 psig]
<b>High Oil Injection Temp (Oil Injection Temperature)</b> This Safety will be active only when Cool Compression is not enabled. See Figure 7-5.			
High Oil Injection Temp Warning	High Oil Injection Temp Inhibit	High Oil Injection Temp Alarm	High Oil Injection Temp Trip
Oil Injection Temperature > High Oil Injection Temperature Alarm	Oil Injection Temperature > High Oil Injection Temperature Alarm	Oil Injection Temperature > High Oil Injection Temperature Alarm	Oil Injection Temperature > High Oil Injection Temperature Trip
<b>Low Oil Injection Temp (Oil Injection Temperature)</b> The Alarm and Trip Setpoints are bypassed at start for a time period (setting of the Oil Injection Temperature Safety Changeover timer). This Setpoint will be activated after the time delay has expired. The Warning condition goes off when the temperature goes below -100 or -73°C. See Figure 7-5.			
Low Oil Injection Temp Warning		Low Oil Injection Temp Alarm	Low Oil Injection Temp Trip
Oil Injection Temperature < -100°F		Oil Injection Temperature < Low Oil Injection Temperature Alarm	Oil Injection Temperature < Low Oil Injection Temperature Trip
<b>Oil Level #1 or #2 (Oil Level)</b> These safeties are available for Cool Compression Feature. This message will appear when Oil Level Float Switch #1 or #2 input is de-energized.			
	Oil Level #1 or #2 Inhibit		Oil Level #1 or #2 Trip
	Oil Level Float Switch #1 or #2 De-energized when compressor is starting		Oil Level Float Switch #1 or #2 De-energized

## Section 7 • Alarms and Trips

Warnings	Inhibits	Alarms	Trips
Not Running (Idle)	Pre-Start	Running	Running
<b>Low Oil Level Trip after Stop (Oil Level Trip after Stop)</b> After Low Oil Separator Safety Trip Delay Timer times out. Cool Compression only.			
			Low Oil Level Trip after Stop
			Power removed from designated input module
<b>Oil Pressure</b> Oil Pressure = (Oil Manifold Pressure – Suction Pressure) When Compressor Type Selected is Single Screw in Configuration Screen  Oil Pressure = (Oil Manifold Pressure – Discharge Pressure) When Compressor Type Selected is VRS in Configuration Screen.			
<b>Low Oil Pressure - Run (Oil Pressure)</b> After the Oil Pressure Bypass Start Timer times out. This is the running oil pressure safety. The normal alarm and trip setpoints of this safety are massaged as soon as the compressor starts. The Prelube Oil Pressure Alarm and Trip setpoints are substituted into this safety setpoints for the duration of the Oil Pressure Bypass timer (typically 60 seconds). After this timer expires, then the setpoints return back to the normal settings. The action of adjusting the setpoints for about a minute allows the (Run) Oil Pressure to build up to normal running pressures after the compressor starts. After the Oil Pressure Bypass Timer has expired, the Oil Pressure must be above the normal setpoints, or else an Alarm or Trip will occur. An alarm or trip will be active if the oil pressure drops below the normal setpoint values after the Oil Pressure Bypass timer has expired. This time limit is set on the Timer menu screen. Run oil pressure is defined as manifold pressure minus suction pressure. See Figure 7-6.			
		Low Oil Pressure Alarm	Low Oil Pressure Trip
		Oil Pressure < Run Oil Pressure Alarm	Oil Pressure < Run Oil Pressure Trip
<b>Start Low Oil Pressure - Start (Oil Pressure)</b> Safeties are active when No Pump is enabled in the configuration screen. Start Low Oil Pressure Stage 1 Pressure Trip will be active if the Oil Pressure drops below this set-point value after the Start Oil Pressure Stage 1 Safety timer has expired and Start Oil Pressure Stage 2 and Low Oil Pressure Safety Bypass Timers are active. Start Low Oil Pressure Stage 2 Pressure Trip will be active if the Oil Pressure drops below this setpoint value after the Start Oil Pressure Stage 2 Safety timer has expired and Low Oil Pressure Safety Bypass Timer is active. Safety timer values are set on the Timer menu screen. See Figure 7-8.			
			Start Low Oil Pressure Trip
			Oil Pressure < Start Low Oil Pressure Stage 1 or Stage 2 Trip

## Section 7 • Alarms and Trips

Warnings	Inhibits	Alarms	Trips
Not Running (Idle)	Pre-Start	Running	Running
<b>Oil Over Pressure</b> Oil Over Pressure = Oil Filter Inlet Pressure – Discharge Pressure. This Oil Over Pressure Setpoint is not for the Cool Compression feature.			
	Oil Over Pressure Inhibit		Oil Over Pressure Trip
	Oil Over Pressure > Oil Over Pressure Trip Setpoint		Oil Over Pressure > Oil Over Pressure Trip Setpoint
<b>High Oil Separator Temp (Oil Separator Temperature)</b> This safety is active when Cool Compression is selected in Configuration Screen. See Figure 7-5.			
		High Oil Separator Temp Alarm	High Oil Separator Temp Trip
		Oil Separator Temperature > High Oil Separator Temperature Alarm	Oil Separator Temperature > High Oil Separator Temperature Trip
<b>Low Oil Separator Temp - Start (Oil Separator Temperature)</b> After Oil Separator Temp Safety Changeover Timer times out at start-up. After a time delay (setting of the Oil Separator Temperature Safety Changeover timer), this safety is deactivated and the Low Oil Separator Run Temperature alarm and safety Setpoints become active. See Figure 7-5.			
Low Oil Separator Start Temp Warning	Low Oil Separator Start Temp Inhibit	Low Oil Separator Temp Alarm	Low Oil Separator Temp Trip
Oil Separator Temperature < Low Oil Separator Start Temperature Alarm	Oil Separator Temperature < Low Oil Separator Start Temperature Alarm	Oil Separator Temperature < Low Oil Separator Start Temperature Alarm	Oil Separator Temperature < Low Oil Separator Start Temperature Trip
<b>Low Oil Separator Temp - Run (Oil Separator Temperature)</b> After Oil Separator Temp Safety Changeover Timer times out at start-up. After a time delay (setting of the Oil Separator Temperature Safety Changeover timer), this safety is deactivated and the Low Oil Separator Run Temperature alarm and safety Setpoints become active. See Figure 7-5.			
		Low Oil Separator Temp Alarm	Low Oil Separator Temp Trip
		Oil Separator Temperature < Low Oil Separator Run Temperature Alarm	Oil Separator Temperature < Low Oil Separator Run Temperature Trip

## Section 7 • Alarms and Trips

Warnings	Inhibits	Alarms	Trips
Not Running (Idle)	Pre-Start	Running	Running
<p><b>Pre-Lube Oil Pressure</b>            Start sequence will be aborted if Inhibit is not cleared within Minimum Compressor Pre-Lube Time. Oil Pump will attempt to generate pre-lube pressure within Low Oil Pressure Safety Bypass timer. This is the prelube oil pump failure safety. If prelube oil pressure does not rise to the prelube alarm setting within the number of set prelube oil pressure trials, (with each trial being the duration of pre-lube oil pressure monitor time), and the prelube oil pressure is not maintained for a minimum time set at Minimum Comp. Prelube Time, then the start sequence will be aborted. The prelube oil pressure trials, prelube oil pressure monitor time, Minimum Comp. Prelube Time are set on the Timer screen. The prelube oil pressure is defined as (manifold pressure - discharge pressure) during the start sequence; zeroed prelube oil pressure difference value is shown on main screen during start sequence. This safety insures adequate lubrication of the compressor at startup. The safety activates for Cycling and Full Time Oil Pump selection.            See Figure 7-6.</p>			
	Prelube Oil Pump Inhibit		Prelube Oil Pressure Trip
	Pre-Lube Pressure < Low Pre-Lube Pressure Alarm		Pre-Lube Pressure (Manifold - Discharge) < Low Pre-Lube Pressure
<p><b>Process Pressure</b>            This option is only available for Process Pressure Control mode, selected in the Control Mode dropdown selection found in the Compressor Control screen.</p>			
<p><b>High Process Pressure (Process Pressure).</b>            See Figure 7-3.</p>			
High Process Pressure Warning	High Process Pressure Inhibit	High Process Pressure Alarm	High Process Pressure Trip
Process Pressure > High Process Pressure Alarm Setpoint #1 or #2	Process Pressure > High Process Pressure Alarm Setpoint #1 or #2	Process Pressure > High Process Pressure Alarm Setpoint #1 or #2	Process Pressure > High Process Pressure Trip Setpoint #1 or #2
<p><b>Low Process Pressure (Process Pressure).</b>            See Figure 7-3.</p>			
Low Process Pressure Warning	Low Process Pressure Inhibit	Low Process Pressure Alarm	Low Process Pressure Trip
Process Pressure < Low Process Pressure Alarm Setpoint #1 or #2	Process Pressure < Low Process Pressure Alarm Setpoint #1 or #2	Process Pressure < Low Process Pressure Alarm Setpoint #1 or #2	Process Pressure < Low Process Pressure Trip Setpoint #1 or #2

## Section 7 • Alarms and Trips

Warnings	Inhibits	Alarms	Trips
Not Running (Idle)	Pre-Start	Running	Running
<b>Process Temperature</b> This option is only available for Process Temperature Control mode, selected in the Control Mode dropdown selection found in the Compressor Control screen.			
<b>High Process Temperature (Process Temperature)</b> See Figure 7-2.			
		High Process Temp Alarm	
		Process Temperature > High Process Temperature Alarm Setpoint #1 or #2	
<b>Low Process Temperature (Process Temperature)</b> See Figure 7-2.			
Low Process Temp Warning	Low Process Temp Inhibit	Low Process Temp Alarm	Low Process Temp Trip
Process Temperature < Low Process Temperature Alarm Setpoint #1 or #2	Process Temperature < Low Process Temperature Alarm Setpoint #1 or #2	Process Temperature < Low Process Temperature Alarm Setpoint #1 or #2	Process Temperature < Low Process Temperature Trip Setpoint #1 or #2
<b>Compressor started in Remote Mode (Remote Comm Time-Out)</b>			
		Remote Comm Time-Out Alarm	Remote Comm Time-Out Trip
		Remote Comm Inactive Time > Communication Failure Detect Timer	Remote Comm Inactive Time > Communication Failure Detect Timer
			Remote Comm Time-Out
			On a Communication Failure, is configured as Stop Compressor with Trip
<b>Low Run Pressure Ratio (Run Pressure Ratio)</b> This safety is active when Cool Compression is enabled in the configuration screen. These Setpoints will be active if the pressure ratio drops below the setpoint values after the Low Pressure Ratio Bypass timer has expired. See Figure 7-9.			
		Low Run Pressure Ratio Alarm	Low Run Pressure Ratio Trip
		Run Pressure Ratio < Low Run Pressure Ratio Alarm	Run Pressure Ratio < Low Run Pressure Ratio Trip

## Section 7 • Alarms and Trips

Warnings	Inhibits	Alarms	Trips
Not Running (Idle)	Pre-Start	Running	Running
<b>SOI [Suction Oil Injection] Oil Pressure</b> SOI Oil pressure (Oil Manifold Pressure - Suction Pressure) Available when SOI Solenoid is enabled in the configuration screen. These safeties are active after the SOI Low Oil Pressure Bypass timer has expired. This time limit is set on the Timer menu screen.			
<b>SOI Low Oil Pressure (SOI Oil Pressure)</b> This is the running oil pressure safety. See Figure 7-7.			
		SOI Low Oil Pressure Alarm	SOI Low Oil Pressure Trip
		SOI Oil Pressure < Low SOI Oil Pressure Alarm	SOI Oil Pressure < Low SOI Oil Pressure Trip
<b>SOI Low Pressure Ratio (SOI Pressure Ratio)</b> This is the low run pressure ratio safety. Depends on Suction and Discharge Pressure value. This Safety is active if Suction Oil Injection Solenoid is enabled in configuration screen. See Figure 7-7.			
		SOI Low Pressure Ratio Alarm	SOI Low Pressure Ratio Trip
		Pressure Ratio < SOI Low Pressure Ratio Alarm	Pressure Ratio < SOI Low Pressure Ratio Trip
<b>Starter</b>			
			Starter Shutdown Trip
			Starter Problem
<b>Low Suction Pressure (Suction Pressure)</b> This message will appear when Suction Pressure falls below the safety setting of Low Suction Pressure Alarm (or Trip) Setpoint #1 or #2. This safety is active in both temperature and pressure control modes. See Figure 7-2.			
Low Suction Pressure Warning	Low Suction Pressure Inhibit	Low Suction Pressure Alarm	Low Suction Pressure Trip
Suction Pressure < Low Suction Pressure Alarm Setpoint No. 1 or No. 2	Suction Pressure < Low Suction Pressure Alarm Setpoint No. 1 or No. 2	Suction Pressure < Low Suction Pressure Alarm Setpoint No. 1 or No. 2	Suction Pressure < Low Suction Pressure Trip Setpoint No. 1 or No. 2
<b>Low Suction Superheat (Suction Superheat Temperature)</b> This is the lowest suction superheat temperature safety. This safety is active when suction superheat monitor is enabled in the configuration screen. See Figure 7-5.			
		Low Suction Superheat Alarm	Low Suction Superheat Trip
		Suction Superheat Temperature < Low Suction Superheat Temperature Alarm	Suction Superheat Temperature < Low Suction Superheat Temperature Alarm

## Section 7 • Alarms and Trips

Warnings	Inhibits	Alarms	Trips
Not Running (Idle)	Pre-Start	Running	Running
<b>Low Suction Temperature (Suction Temperature)</b> See Figure 7-5.			
Low Suction Temp Warning	Low Suction Temp Inhibit	Low Suction Temp Alarm	Low Suction Temp Trip
Suction Temperature < Low Suction Temperature Alarm	Suction Temperature < Low Suction Temperature Alarm	Suction Temperature < Low Suction Temperature Alarm	Suction Temperature < Low Suction Temperature Trip
<b>Volume Position Trip</b> This message will appear if condition exists following any shutdown. See Figure 7-5.			
			Volume Position Trip
			Volume Slides failing to unload < 5% during Volume Unload Cycle



## Section 8 • Timers

### Overview

The timers screen allows the operator to view and adjust timer settings associated with compressor operation. There are different types of timers that the operator should be aware of listed below. For Timer Screen Pages, see Figures 8-1 and 8-2.

#### Changeover:

- The changeover timers will change from one type control to another once the compressor has started and then the timer has expired.

#### Bypass:

- The bypass timers prevent certain alarm and trip checks from occurring until the compressor has started and then the time has expired.

#### Delays:

- Delays require the condition to occur for the specified amount of time.

#### Timers:

- A general timer requiring the time to expire before the listed event can occur.

### Timer Setpoints

#### Capacity Increase Start Delay:

- At compressor startup, the capacity slide position is held at minimum position for this time period. This is to allow compressor and system conditions to stabilize. After the timer expires, the slide is free to move in accordance to the system demands.

#### Minimum Compressor Pre-lube Time:

- This is the length of time the oil pump will run, after establishing Pre-lube Oil Pressure, to prime the oil circuit before starting the compressor.

#### Low Oil Pressure Safety Bypass:

- This is the length of time in which the normal Low

The screenshot shows the 'Timers Screen - Page 1' interface. At the top, it displays 'Suction Pressure 1', 'Stopped', and '19.8 Psig Δ'. The main area contains a table of timer settings:

Setpoint	Value
Capacity Increase Start Delay	5 sec
Minimum Comp. Prelube Time	5 sec
Low Oil Pressure Safety Bypass	60 sec
Prelube Oil Pressure Monitor Time	20 sec
Prelube Oil Pressure Monitor Trials	3
Prelube Oil Pressure Safety Changeover	10 sec
High Filter Diff. Press Safety Changeover	60 sec
Oil Level #1 Trip Delay	60 sec
Oil Level #2 Trip Delay	60 sec
Low Oil Sep. Temp. Safety Changeover	5 min
Low Oil Injection Safety Bypass	6 min

On the right side, there are controls for 'Capacity Slide' (1.4%) and 'Volume Slide' (1.1%), along with buttons for 'Stop', 'Remote Lock Out', 'Alarm Reset', and 'Unit Start'. Below these are system status sections: 'Suction Press Control' (Setpoint 20.0 Psig), 'Suction' (Press 39.8 Psig, Temp 8.6 °F), 'Discharge' (Press 109.7 Psig, Temp -37.8 °F), 'Discharge : Suction' (Press Ratio 2.3), and 'Oil' (Press Diff 182.2 Psig, Filter Diff -19.3 Psig, Inj Temp 81.5 °F, Sep Temp 113.7 °F). At the bottom, there are navigation buttons (Maintenance, User Access, Log off, Help), status bars ('No Scheduled Maintenance', 'No Alarm/Trips Present'), and user information (User: admin, 08/05/2016 03:09:03, Run Hours: 0).

Figure 8-1. Timers Screen - Page 1

## Section 8 • Timers

---

(Run) Oil Pressure setpoints will be adjusted by the values of the Pre-lube Oil Pressure setpoints. After the timer has expired, the normal Low Oil Pressure setpoints become active.

**Prelube Oil Pressure Monitor Time:**

- The Prelube Oil Pressure Monitor time defines timer to monitor raise in prelube oil pressure against prelube oil pressure alarm settings. If prelube oil pressure is unable to raise by oil pressure alarm settings in Prelube oil pressure monitor time then it restarts oil pump.

**Prelube Oil Pressure Monitor Trials:**

- The Prelube oil pressure monitor trials defines maximum number of retries to monitor prelube oil pressure.

**Prelube Oil Pressure Safety Changeover:**

- After compressor starts, the drop in prelube oil pressure is monitored for prelube oil pressure safety changeover time. If prelube oil pressure drops within prelube oil pressure safety changeover time then compressor trips on prelube oil pressure trip.

**High Filter Differential Pressure Safety Changeover:**

- This timer bypasses the High Filter Differential Run Pressure safety settings when the compressor starts. It defines how long the High Filter Differential Start Pressure setpoints will be active after the compressor starts. After the timer has expired, then the High Filter Differential Run Pressure safety setpoints will be active.

**Oil Separator Level #1 Safety Trip Delay:**

- This timer bypasses the low oil level switch for momentary drops in the oil level. This timer activates when the low oil level switch opens, and deactivates when the switch closes. If the switch is still open after the timer has timed out, the compressor will be shut down and a trip message will be displayed. This timer is available if the unit is equipped with a low oil separator float switch (the oil level switch is standard on all liquid injection units and optional on all others).

**Oil Separator Level #2 Safety Trip Delay:**

- This timer bypasses the low oil level switch for momentary drops in the oil level. This timer activates when the low oil level switch opens, and deactivates when the switch closes. If the switch is still open after the timer has timed out, the compressor will be shut down and a trip message will be displayed. This timer is available if the unit is equipped with a low oil separator float switch (the oil level switch is standard on all liquid injection units and optional on all others).

**Low Oil Separator Temperature Safety Changeover:**

- This timer allows Low Oil Separator Start Temperature safety setpoint to protect the compressor against cold oil during starting. After the timer has expired, the Low Oil Separator Run Temperature is then active.

**Low Oil Injection Temperature Safety Bypass:**

- This timer bypasses the Low Oil Injection Temperature Safety setpoint during start-up, to allow any cold oil in the oil lines and filter to pass. After the timer expires, the Low Oil Injection Temperature safety is active.

**Communication Failure Detect Timer:**

- This timer forces the compressor to wait for the set time period before displaying “Remote Comm Time-out” Alarm in yellow banner or “Remote Comm Time-out” Trip in red banner when there is no remote communication to Vission 20/20 for configured time.

**Max Restart After Power Failure:**

- This timer forces the compressor to wait for the set time period after a power failure and for the panel’s restart before it can be started automatically. By staggering the time settings of this timer between other compressor panels, the compressors can be allowed to start automatically, one at a time, after a power failure. This will prevent excessive load demand on the power system that could occur if all of the compressor equipment were to start at the same time. The Power-up Auto Re-Start [x]Enable option must be selected on the Configuration screen for this option to be active.

**Hot Starts per Hour:**

- This counter counts compressor starts. After every start, a one-hour timer is reset and starts timing. If the timer times out, the hot starts counter is reset. When the counter reaches its preset value, it will not allow another compressor start until the one-hour timer times out and resets the counter. The hot starts counter, therefore, will be reset when the time between compressor starts total one hour. This counter allows repetitive compressor starts, but once the counter has reached its set point, it requires a one-hour window between compressor starts in order for the counter to be reset.

**True Anti-Recycle Timer:**

- Once the compressor turns off, this timer will keep the compressor off for the setting of the True Anti-Recycle Timer. This timer is used to prevent short cycling of the compressor.

## Section 8 • Timers

Accumulative Anti-Recycle Timer:

- This timer forces a specified time between compressor starts. When the compressor starts, the timer resets and starts timing and accumulates running time. Once the compressor shuts down, it will not be allowed to restart for the remainder of time left on the Accumulative Anti-Recycle Timer. Unlike the True Anti-Recycle Timer, if the compressor has run for a time period that exceeds the setpoint of the Accumulative Anti-Recycle Timer, then when the compressor shuts down, it will be allowed to restart immediately.

Compressor Interlock Bypass:

- Once the Vission 20/20 has sent a command to the compressor starter to start, a return signal is expected. This timer defines how much time to wait for that signal before setting a trip condition.

High Motor Amps Safety Bypass:

- Starting motors can typically pull much more than its rates full load amps for a short time. This timer ignores that sudden inrush of current for the specified

time.

Emergency Stop Timer:

- Defines the amount of time the compressor is in a False start condition before activating the Emergency stop. The emergency stop output can be connected to a shunt-trip in the case of a run away compressor to remove all power to the system.

Low Suction Pressure Safety Bypass:

- Sets the time that the compressor is allowed to run at lower suction pressure than would usually be allowed at start-up.

High Superheat Temp Safety Changeover:

- This timer activates at shutdown and changes the restart parameters if the time has not been met.

Low Pressure Ratio Bypass:

- This timer bypasses the Low Run Pressure Ratio setpoints when compressor is running. After the timer expires, the Cool Compression Low Run Pressure Ratio safety is active.

The screenshot displays the 'Timers Screen - Page 2 (Cool Compression)'. The main area is a table of timer settings:

Parameter	Value
Communication Failure Detect Timer	1 min
Max Restart After Power Failure	5 min
Hot Starts per Hour	5
True Anti-Recycle Timer	20 min
Accumulative Anti-Recycle Timer	20 min
Compressor Interlock Bypass	10 sec
High Motor Amps Safety Bypass	15 sec
Emergency Stop Timer	10 min
Low Suction Pressure Safety Bypass	0 sec
High Superheat Temp Safety Changeover	10 min
Low Pressure Ratio Bypass	30 sec

On the right side, there are control panels for 'Capacity Slide' (0.5%) and 'Volume Slide' (0.0%), along with buttons for 'Stop', 'Remote Lock Out', 'Alarm Reset', and 'Unit Start'. Below these are system status indicators:

- Suction Press Control:** Setpoint 20.0 Psig
- Suction:** Press 45.8 Psig, Temp 60.3 °F
- Discharge:** Press 169.3 Psig, Temp 127.2 °F, Superheat 35.8 °F
- Discharge : Suction:** Press Ratio 3.0
- Oil:** Press Diff 114.3 Psig, Filter Diff 7.9 Psig, Inj Temp 116.9 °F, Sep Temp 110.1 °F
- Motor:** Amperage 0.0 Amps

At the bottom, there are navigation buttons (Maintenance, User Access, Log off, Help), status messages ('No Scheduled Maintenance', 'No Alarm/Trips Present'), and user information (User: admin, Date: 09/08/2016, Time: 09:04:21, Run Hours: 0).

Figure 8-2. Timers Screen - Page 2 (Cool Compression)

## Section 8 • Timers

Reference Figure 8-3.

SOI Low Oil Pressure Safety Bypass:

- This timer bypasses the SOI Low Oil Pressure Safety set-points during start-up. After the timer expires, the SOI Low Oil Pressure safety is active.

SOI Low Pressure Ratio Safety Bypass:

- This timer bypasses the SOI Low Pressure Ratio Safety set-points during start-up. After the timer expires, the SOI Low Pressure Ratio safety is active.

The screenshot displays the 'Timers Screen - Page 2 (SOI Solenoid)'. The interface is divided into several sections:

- Top Header:** Suction Pressure 1, Stopped, 10.5 Psig Δ
- Left Panel:** Setpoint, Max Limit, Min Limit
- Table of Timers:**

Timer Name	Value
Communication Failure Detect Timer	1 min
Max Restart After Power Failure	5 min
Hot Starts per Hour	3
True Anti-Recycle Timer	20 min
Accumulative Anti-Recycle Timer	20 min
Compressor Interlock Bypass	10 sec
High Motor Amps Safety Bypass	15 sec
Emergency Stop Timer	10 min
Low Suction Pressure Safety Bypass	0 sec
High Superheat Temp Safety Changeover	10 min
SOI Low Oil Pressure Safety Bypass	15 sec
SOI Low Pressure Ratio Safety Bypass	60 sec
- Right Panel:** Capacity Slide (0.0%), Volume Slide (0.0%), Stop, Remote Lock Out, Alarm Reset, Unit Start
- System Status:**
  - Suction Press Control: Setpoint 20.0 Psig
  - Suction: Press 30.5 Psig, Temp 53.6 °F
  - Discharge: Press 109.2 Psig, Temp 68.5 °F
  - Discharge : Suction: Press Ratio 2.7
  - Oil: Press Diff 139.2 Psig, Filter Diff 10.3 Psig, Inj Temp 114.0 °F, Sep Temp 111.0 °F
  - Motor: Amperage 0.0 Amps
- Bottom Panel:** Maintenance, User Access, Log off, Help, No Scheduled Maintenance, No Alarm/Trips Present, User admin, 09/29/2014 16:04:56, Run Hours 0

Figure 8-3. Timers Screen - Page 2 (SOI Solenoid)

## Section 8 • Timers

Reference Figure 8-4.

Start Oil Pressure Stage 1 Safety Timer:

- This timer starts when compressor is started. Once this timer is lapsed Oil Pressure will get monitored against Start Oil Pressure Stage 1 Pressure Trip Setpoint. This Setpoint is configurable only when No Pump is selected in Configuration Screen.

Start Oil Pressure Stage 2 Safety Timer:

- This timer starts when compressor is started. Once this timer is lapsed Oil Pressure will get monitored against Start Oil Pressure Stage 2 Pressure Trip Setpoint. This Setpoint is configurable only when No Pump is selected in Configuration Screen.

The screenshot displays the 'Timers Screen - Page 2 (No Oil Pump)'. The interface is divided into several sections:

- Top Bar:** Shows 'Suction Pressure 1', 'Stopped', and '3.4 Psig Δ'. On the right, there are 'Capacity Slide' (2.6%) and 'Volume Slide' (3.3%) controls, along with buttons for 'Stop', 'Remote Lock Out', 'Alarm Reset', and 'Unit Start'.
- Timer Settings Table:** A table with columns for 'Setpoint', 'Max Limit', 'Min Limit', and 'Value'.
 

Setpoint	Max Limit	Min Limit	Value
			Communication Failure Detect Timer: 1 min
			Max Restart After Power Failure: 5 min
			Hot Starts per Hour: 3
			True Anti-Recycle Timer: 20 min
			Accumulative Anti-Recycle Timer: 20 min
			Compressor Interlock Bypass: 10 sec
			High Motor Amps Safety Bypass: 15 sec
			Emergency Stop Timer: 10 min
			Low Suction Pressure Safety Bypass: 0 sec
			High Superheat Temp Safety Changeover: 10 min
			Start Oil Pressure Stage 1 Safety Timer: 5 sec
			Start Oil Pressure Stage 2 Safety Timer: 15 sec
- System Status:**
  - Suction Press Control:** Setpoint 20.0 Psig
  - Suction:** Press 23.4 Psig, Temp 27.4 °F
  - Discharge:** Press 97.4 Psig, Temp 55.9 °F
  - Discharge : Suction:** Press Ratio 2.9
  - Oil:** Press Diff 89.4 Psig, Filter Diff 9.2 Psig, Inj Temp 111.0 °F, Sep Temp 123.1 °F
  - Motor:** Amperage 0.0 Amps
- Navigation and Status:**
  - Page 1 | 2 | Menu
  - Maintenance | User Access | Log off | Help
  - No Scheduled Maintenance
  - No Alarm/Trips Present
  - User: admin
  - Date/Time: 04/05/2016 07:43:21
  - Run Hours: 0

Figure 8-4. Timers Screen - Page 2 (No Oil Pump)

## Section 9 • Compressor Scheduling

### Overview

This menu allows the operator to schedule control setpoint switching during the day and week. This feature can be enabled and disabled from the Compressor Schedule screen. Up to four setpoint “switch” events can be scheduled per day, see Figure 9-1.

### Scheduling Setpoint

Schedule:

- The options for selection are “Enable” & “Disable”. The operator is allowed to configure setpoints related to scheduled events, but only when the schedule is disabled.
- The operator can Enable Compressor Scheduling Feature, only if Time Intervals are in order of Event 1 < Event 2 < Event 3 < Event 4 for all days. If events are not in order, invalid events are marked with caution

symbol to indicate the operator to correct events and then enable feature.

Control Mode:

- These drop-down boxes allow selection of operating modes which get switched once schedule event time is achieved.
- The list of allowable modes depends on the number of controllers selected in the configuration screen. For example, if the number of Suction Pressure Control Setpoints selected is “2” and the number of Process Temperature Control Setpoints selected is “1”, then Control Mode drop-down box will have “Unscheduled”, “Suction Pressure SP1”, “Suction Pressure SP2” and “Process Temperature SP1” as options for selection.
- If Control Mode is selected as “Unscheduled” and Time set in an event is achieved, then control mode will not get switched. Hence Control Mode can be set as “Unscheduled” if operator does not want to use all 4 events per day.

The screenshot displays the Compressor Scheduling interface. At the top, it shows 'Process Control 1', 'Stopped', and '1.6 Psig Δ'. The main area is divided into a scheduling section and a status section.

**Scheduling Section:**

- Schedule:** Radio buttons for 'Enabled' and 'Disabled' (selected).
- Days:** Sunday, Monday, Tuesday, Wednesday, Thursday, Friday, Saturday.
- Control Mode:** Suction Pressure SP1, Process Control SP1, Suction Pressure SP2, Process Control SP2.
- Time:** 01:05 PM, 01:10 PM, 01:15 PM, 01:20 PM.

**Status Section (Right Side):**

- Capacity Slide:** 0.5 % (Stop button)
- Volume Slide:** 0.0 % (Remote Lock Out, Alarm Reset, Unit Start buttons)
- Process Press Control:** Setpoint 20.0 Psig
- Suction:** Press 20.7 Psig, Temp 26.2 °F
- Discharge:** Press 91.6 Psig, Temp 25.5 °F, Superheat -33.7 °F
- Discharge : Suction:** Press Ratio 3.0
- Oil:** Press Diff 141.4 Psig, Filter Diff 4.2 Psig, Inj Temp 97.5 °F, Sep Temp 69.4 °F
- Motor:** Amperage 0.0 Amps

**Bottom Bar:**

- Maintenance, User Access, Log off, Help buttons.
- No Scheduled Maintenance
- No Alarm/Trips Present
- User: admin
- 07/28/2015 01:55:52
- Run Hours: 11

Figure 9-1. Compressor Scheduling Screen

## Section 9 • Compressor Scheduling

---

### Time:

- This setpoint allows selection of Hours, Minutes and AM/PM values for an event. When time set for an event is achieved, control mode will get changed as selected for that event.
- The range of values allowed to set for Hours setpoint is 1– 12 for 12 hour format and 0 – 23 for 24 hour format. The range of values allowed to set for Minutes setpoint is 0 – 59. AM/PM selection is active for selection only when Time Format selected in configuration screen is 12 hour.

When the scheduling feature is enabled and No. of controllers for Suction Pressure Control & Process Temperature Control are changed in configuration screen (which makes control modes selected in compressor scheduling screen invalid), then the feature will get disabled automatically and indication will be sent to operator to correct the setting.

## Section 10 • Compressor Sequencing

### Overview

The compressor sequencing screen is where more than one Vission 20/20 panel can be sequenced in network using Modbus TCP. These settings define how the master compressor should control sequenced Vission 20/20 panels. This feature is enabled from the Configuration Screen, see Section 19 for Compressor Sequencing.

When Compressor Sequencing is running, a status icon will appear on the bottom left corner of the main screen to make the user aware of it.

### Compressor Sequencing Table

The compressor sequencing table's menu allows the operator to view and adjust settings that are used for compressor sequencing, see Figure 10-1.

Device Name:

- This is a read-only value. The device Name can be changed from the Configuration Screen, as long as an actual name is chosen, it can't be empty.

Min Trigger:

- Defines the Master's capacity value in percentage which is used as a trigger to step wise decrease the slave's compressor capacity. Slave compressor capacity is decreased only if the Master is running with capacity lower than set Min Trigger value.

Max Trigger:

- Defines the Master's capacity value in percentage which is used as a trigger to step wise increase the slave's compressor capacity. Slave compressor capacity is increased only if the Master is running with capacity higher than set Max Trigger value.

Equipment:

- Options of this combo box are updated depending on devices shown in Devices List Page. This contains names of all the compressors in the network communicating with the Master compressor. The equipment

The screenshot shows the Compressor Sequencing Screen with the following components:

- Top Bar:** Suction Pressure 1, Stopped, 6.0 Psig Δ, Capacity Slide (0.0%), Stop, Remote Lock Out, Volume Slide (0.0%), Alarm Reset, Unit Start.
- Master Compressor Settings:** Device Name: Master, Min Trigger: 70%, Max Trigger: 85%.
- Equipment Table:**

Equipment	Control	Priority	Step	Min Cap	Max Cap	Status
Slave 1	ON	1	10%	10%	95%	✓
Slave 2	ON	2	10%	10%	95%	✓
Slave 3	ON	3	10%	10%	95%	✓
None	OFF	4	10%	10%	95%	—
None	OFF	5	10%	10%	95%	—
None	OFF	6	10%	10%	95%	—
None	OFF	7	10%	10%	95%	—
None	OFF	8	10%	10%	95%	—
None	OFF	9	10%	10%	95%	—
- Machine Timers:** Start Time: 90 sec, Stop Time: 90 sec, Accelerated Shut Down Timer: 60 sec.
- Page Navigation:** Page 1, 2, 3, 4, 5, 6, Menu.
- Bottom Bar:** Maintenance, User Access, Log off, Help, Master, User: admin, 11/07/2014 18:21:05, Run Hours: 0.
- Real-time Data:**
  - Suction Press Control: Setpoint 20.0 Psig
  - Suction: Press 26.0 Psig, Temp 54.8 °F
  - Discharge: Press 128.4 Psig, Temp 71.2 °F
  - Discharge : Suction: Press Ratio 3.5
  - Oil: Press Diff 144.5 Psig, Filter Diff 9.4 Psig, Inj Temp 113.7 °F, Sep Temp 109.6 °F
  - Motor: Amperage 0.0 Amps
- Status:** No Scheduled Maintenance, No Alarm/Trips Present.

Figure 10-1. Compressor Sequencing Screen - Page 1



## Section 10 • Compressor Sequencing

---

name can be selected from the drop-down list. The same Equipment name should not be configured more than once in the sequencing table.

Control:

- Inclusion/exclusion of compressor partaking in the sequencing can be decided on basis of this toggle button. Compressors can be included/excluded by toggling ON/OFF.

### NOTE

Switching a compressor control to OFF when running in Auto Seq mode puts the respective slave compressor into local auto mode. This feature is used to add or remove slave compressors from the sequence table when running in Auto Seq mode.

Priority:

- This defines the priorities of the compressors on the network. This priority will decide the sequence in which compressors will be turned on and off during the sequence cycle. The lower the priority number, the greater the priority of the compressor.

Step:

- This parameter would decide the stepwise increase or decrease value in percentage of the compressor capacity. In the case the last step makes the total capacity greater than the maximum capacity, total capacity will get reduced to maximum capacity. Same is applicable when the last step makes the total capacity lower than the minimum capacity, then minimum capacity takes priority.

Min Cap:

- Defines the lowest capacity in percentage at which a compressor is allowed to run. Minimum capacity value has precedence over first step value.

Max Cap:

- Defines the highest capacity in percentage at which a compressor is allowed to run. Maximum capacity value has precedence over last step value.

Status Symbols:

- The status symbols show status of Slave compressors on the sequencing table, see Table 10-1. For further details, see Application Notes.

Machine Start Timer:

- Machine Start timer shows the time in seconds that the Master Compressor will hold before starting slave compressor once the Start decision is taken.

Machine Stop Timer:

- Machine Stop timer shows the time in seconds that the Master Compressor will hold before stopping slave compressor once the Stop decision is taken.

Accelerated Shut Down Timer:

- Accelerated Shut Down timer shows the time in sec that the Master Compressor will hold before stopping slave compressors due to Auto-Cycle Stop Setpoint.

## Section 10 • Compressor Sequencing











### Status Symbols

Compressor sequencing status symbols are automatically refreshed every 10 seconds. For symbols, see Table 10-1.

#### NOTE

Before configuring the Sequencing table on the Master Compressor, log on to the slave compressors one by one and enable sequencing in slave mode, and put each slave in Remote mode. Then log on to Master Compressor and wait till all slaves show up under detected devices pop-up screen. Add slaves, which in turn will get shown in Devices List Screen and also in Equipment combo-box.

**Table 10-1. Status Symbols**

Symbol	Description
	Default, If slave Compressor is not present.
	Slave Compressor is configured in sequencing table but is not configured in "Remote" mode or is not detected in network.
	Slave Compressor configured in sequencing table and is in ready to run state.
	Slave Compressor is running with Alarm condition.
	Slave Compressor stopped due to Error Condition.
	Slave Compressor running at maximum capacity without any error.
	Slave Compressor under active control of Master Compressor
	Slave Compressor running into its stop timer, will be stopped.
	Slave Compressor is next in sequence for unloading.
	Slave Compressor running into its start timer, will be started.

## Section 10 • Compressor Sequencing

### Suction Pressure Control Setpoints

The Compressor sequencing screen defines settings that are used by the master compressor for sequencing. For Suction Pressure Control Setpoints see Figure 10-2.

#### PRESSURE SETPOINTS

Start Offset:

- Defines the offset from suction pressure control setpoint to start slave compressor. If suction pressure surpasses start offset setpoint and master compressor's capacity has reached max trigger setpoint, then the sequencing algorithm allows the starting and loading of slave compressors to cater for increasing load requirements.

Setpoint:

- The target setpoint is a read-only value here. This setpoint can be changed by logging on to the "Compressor Control" Screen.

Fast Load Pressure Offset:

- Defines the offset from suction pressure control setpoint to monitor compressor load. If suction pressure surpasses this setpoint's value then sequencing decisions are made according to the Fast Load Timer.

Fast Unload Pressure Offset:

- Defines the offset from suction pressure control setpoint to monitor compressor load. If suction pressure

drops below this setpoint's value then sequencing decisions are made according to Fast Unload Timer.

#### CAPACITY LOAD/UNLOAD TIMERS

One of the following Capacity Load/Unload timers is used to make sequencing decisions periodically. Suction Pressure setpoints are monitored to identify which one of the following timers will be used.

Slow Load Timer:

- If suction pressure surpasses the suction pressure control setpoint then this timer's value is used to make periodic sequencing decisions.

Fast Load Timer:

- If suction pressure surpasses the fast load pressure offset setpoint then this timer's value is used to make periodic sequencing decisions.

Slow Unload Timer:

- If suction pressure drops below the suction pressure control setpoint then this timer's value is used to make periodic sequencing decisions.

Fast Unload Timer:

- If suction pressure drops below the fast unload pressure offset setpoint then this timer's value is used to make periodic sequencing decisions.

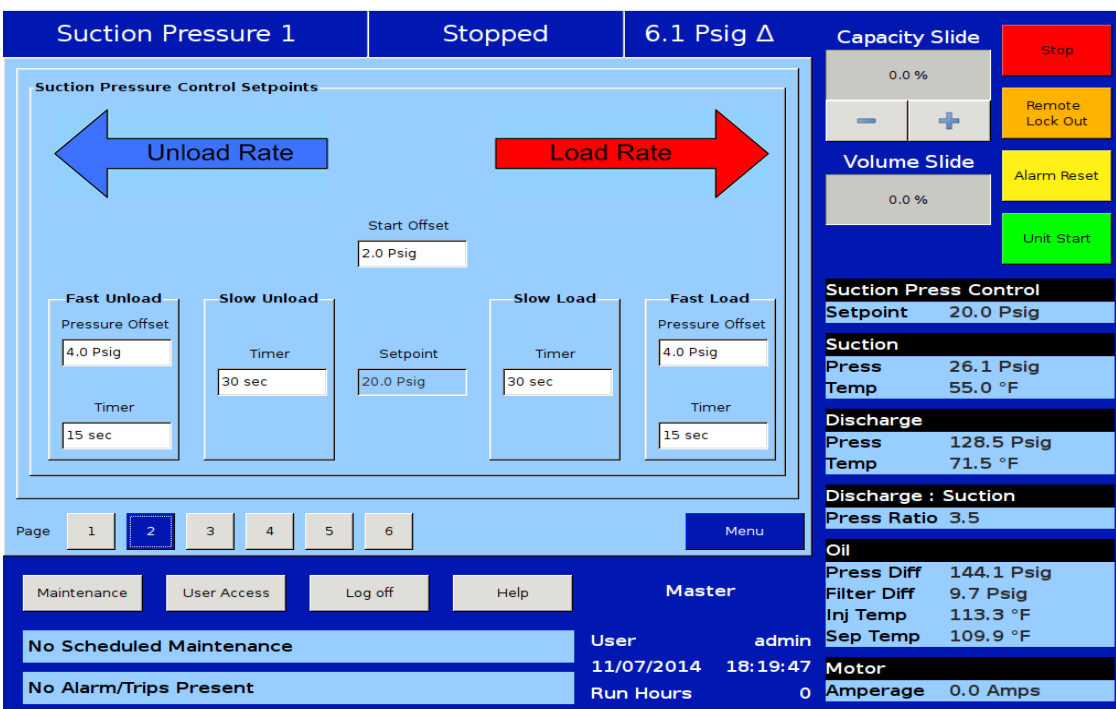

Figure 10-2. Compressor Sequencing Screen - Suction Pressure Control Setpoints (Page 2)

## Section 10 • Compressor Sequencing

### Process Control Setpoints - Temperature

The compressor sequencing screen defines settings that are used by the master compressor for sequencing, depending on the Process Control Mode.

When the Process Control Mode selected is Temperature, sequencing uses temperature setpoints, see Figure 10-3.

#### TEMPERATURE SETPOINTS

Start Offset:

- Defines the offset from the process temperature control setpoint to start the slave compressor. If the process temperature surpasses the start offset setpoint and the master compressor's capacity has reached max trigger setpoint then the sequencing algorithm allows the starting and loading of slave compressors to cater for increasing load requirements.

Setpoint:

- The target setpoint is a read-only value here. This setpoint can be changed by logging on to "Compressor Control" Screen.

Fast Load Temp Offset:

- Defines the offset from the process temperature control setpoint to monitor compressor load. If process temperature surpasses this setpoint's value then the

sequencing decisions are made according to Fast Load Timer.

Fast Unload Pressure Offset:

- Defines the offset from the process temperature control setpoint to monitor compressor load. If process temperature drops below this setpoint's value then the sequencing decisions are made according to Fast Unload Timer.

#### CAPACITY LOAD/UNLOAD TIMERS

One of the following Capacity Load/Unload timers is used to make sequencing decisions periodically. Process Temperature setpoints are monitored to identify which one of the following timers to be used.

Slow Load Timer:

- If process temperature surpasses the process temperature control setpoint then this timer's value is used to make periodic sequencing decisions.

Fast Load Timer:

- If process temperature surpasses the fast load temp offset setpoint then this timer's value is used to make periodic sequencing decisions.

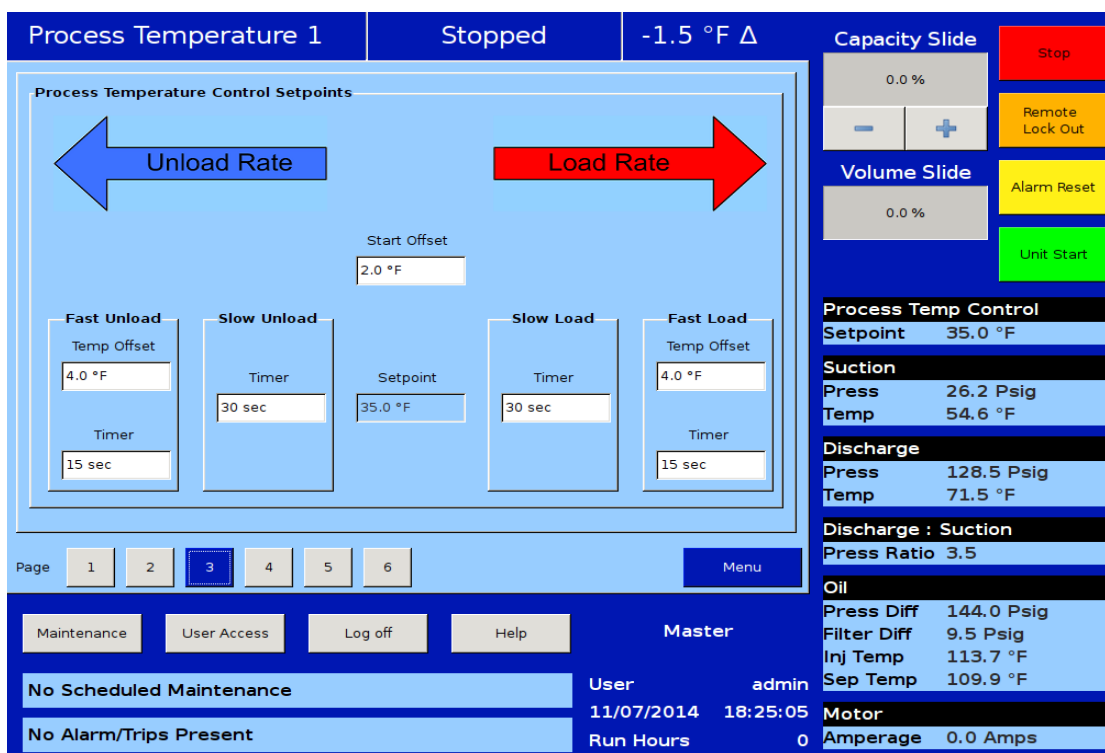

Figure 10-3. Compressor Sequencing Screen - Process Control Setpoints for Temperature

## Section 10 • Compressor Sequencing

Slow Unload Timer:

- If process temperature drops below the process temperature control setpoint then this timer's value is used to make periodic sequencing decisions.

Fast Unload Timer:

- If process temperature drops below the fast unload temp offset setpoint then this timer's value is used to make periodic sequencing decisions.

### Process Control Setpoints - Pressure

The compressor sequencing screen defines settings that are used by the master compressor for sequencing depending on the Process Control Mode.

When the Process Control Mode selected is Pressure, sequencing uses pressure setpoints, see Figure 10-4.

#### PRESSURE SETPOINTS

Start Offset:

- Defines the offset from the process pressure control setpoint to start slave compressor. If the process pressure surpasses the start offset setpoint and master compressor's capacity has reached max trigger setpoint then the sequencing algorithm allows the starting and loading of slave compressors to cater for increasing load requirements.

Setpoint:

- The target setpoint is a read-only value here. This setpoint can be changed by logging on to the "Compressor Control" Screen.

Fast Load Temp Offset:

- Defines the offset from the process pressure control setpoint to monitor compressor load. If process pressure surpasses this setpoint's value then sequencing decisions are made according to Fast Load Timer.

Fast Unload Pressure Offset:

- Defines the offset from the process pressure control setpoint to monitor compressor load. If process pressure drops below this setpoint's value then sequencing decisions are made according to Fast Unload Timer.

#### CAPACITY LOAD/UNLOAD TIMERS

One of the following Capacity Load/Unload timers is used to make sequencing decisions periodically. Process Pressure setpoints are monitored to identify which one of the following timers will be used.

Slow Load Timer:

- If process pressure surpasses the process pressure control setpoint then this timer's value is used to make periodic sequencing decisions.

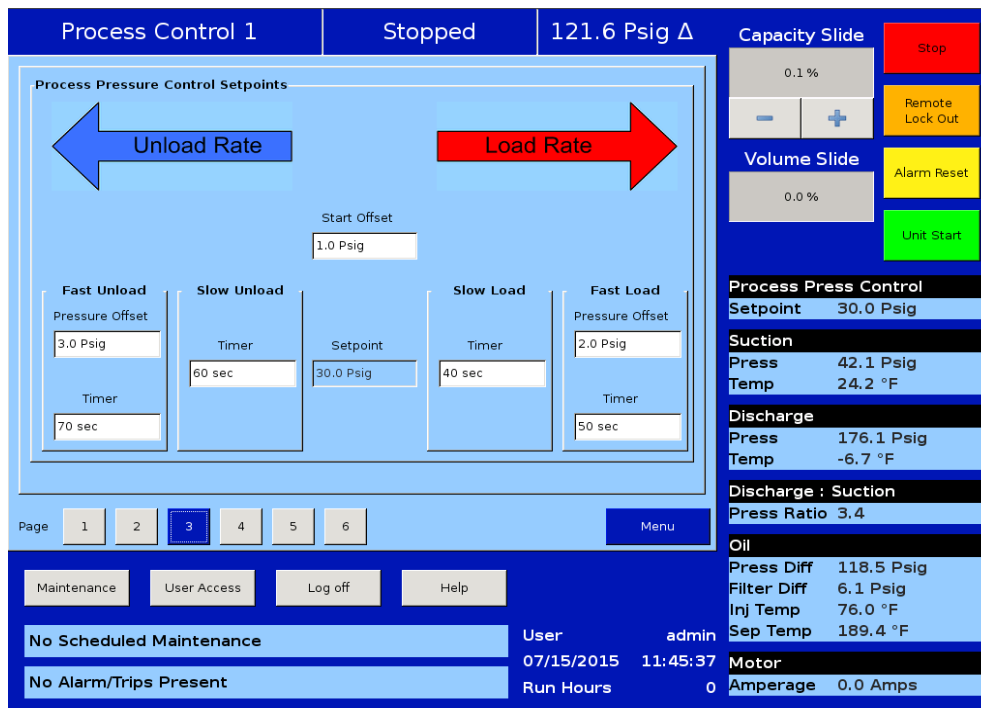

Figure 10-4. Compressor Sequencing Screen - Process Control Setpoints for Pressure

## Section 10 • Compressor Sequencing

Fast Load Timer:

- If process pressure surpasses the fast load temp offset setpoint then this timer's value is used to make periodic sequencing decisions.

Slow Unload Timer:

- If process pressure drops below the process pressure control setpoint then this timer's value is used to make periodic sequencing decisions.

Fast Unload Timer:

- If process pressure drops below the fast unload temp offset setpoint then this timer's value is used to make periodic sequencing decisions.

### Discharge Pressure Control Setpoints

The compressor sequencing screen defines settings those are used by the master compressor for sequencing. For Discharge Pressure Control Setpoints, see Figure 10-5.

#### PRESSURE SETPOINTS

Start Offset:

- Defines the offset from the discharge pressure control setpoint to start the slave compressor. If discharge pressure drops below the start offset setpoint and master compressor's capacity has reached max trigger setpoint then the sequencing algorithm

allows the starting and loading of slave compressors to cater for increasing load requirements.

Setpoint:

- The target setpoint is a read-only value here. This setpoint can be changed by logging on to the "Compressor Control" Screen.

Fast Load Pressure Offset:

- Defines the offset from the discharge pressure control setpoint to monitor compressor load. If the discharge pressure drops below this setpoint's value then sequencing decisions are made according to Fast Load Timer.

Fast Unload Pressure Offset:

- Defines the offset from the discharge pressure control setpoint to monitor compressor load. If the discharge pressure surpasses this setpoint's value then sequencing decisions are made according to Fast Unload Timer.

### Capacity Load/Unload Timers

One of the following Capacity Load/Unload timers is used to make sequencing decisions periodically. Discharge Pressure setpoints are monitored to identify which one of the following timers to be used.

Slow Load Timer:

- If discharge pressure drops below the discharge

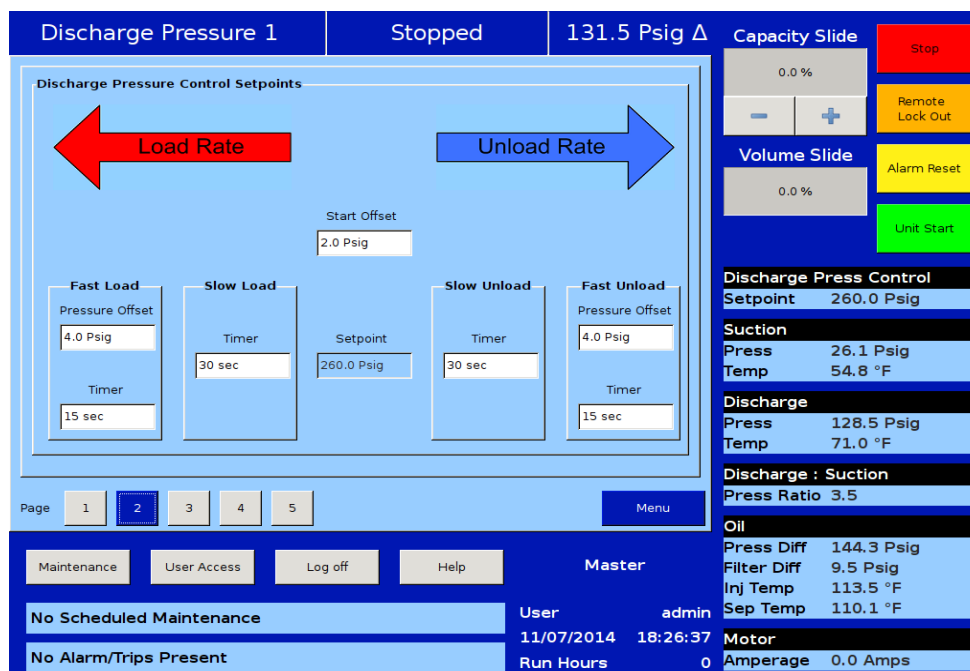

Figure 10-5. Compressor Sequencing Screen - Discharge Pressure Control Setpoints (Page 2)

## Section 10 • Compressor Sequencing

pressure control setpoint then this timer's value is used to make periodic sequencing decisions.

Fast Load Timer:

- If discharge pressure drops below the fast load pressure offset setpoint then this timer's value is used to make periodic sequencing decisions.

Slow Unload Timer:

- If discharge pressure surpasses the discharge pressure control setpoint then this timer's value is used to make periodic sequencing decisions.

Fast Unload Timer:

- If discharge pressure surpasses the fast unload pressure offset setpoint then this timer's value is used to make periodic sequencing decisions.

### Devices List

This screen is designed to add, display, delete and test connection with slave compressors that are used by

the master compressor for sequencing. For Devices List screen see Figure 10-6.

### DEVICES LIST COLUMNS

Device Name:

- Displays the Name of the Slave Compressor.

Device Type:

- Displays the type of the Slave Compressor controller, whether it's Vision 20/20 or Vission.

IP Address:

- Displays the IP Address of the Slave Compressor.

Device ID:

- Displays the Device ID of the Slave Compressor.

CFM:

- Displays the CFM of the Slave Compressor.

The screenshot shows a control interface for a compressor system. At the top, it displays 'Suction Pressure 1', 'Stopped', and '6.1 Psig Δ'. The main area is titled 'Devices List' and contains a table with the following data:

Device Name	Device Type	IP Address	Device ID	CFM
Slave 1	Vission 20/20	192.168.1.95	5	483
Slave 2	Vission 20/20	192.168.1.97	7	483
Slave 3	Vission 20/20	192.168.1.98	8	483

Below the table are buttons for 'View Detected Devices', 'Add Device', 'Delete Device', and 'Test Connection'. The interface also features 'Capacity Slide' and 'Volume Slide' controls, both currently at 0.0%. On the right side, there are buttons for 'Stop', 'Remote Lock Out', 'Alarm Reset', and 'Unit Start'. The bottom right section displays various system parameters:

- Suction Press Control:** Setpoint 20.0 Psig
- Suction:** Press 26.1 Psig, Temp 55.0 °F
- Discharge:** Press 128.4 Psig, Temp 71.5 °F
- Discharge : Suction:** Press Ratio 3.5
- Oil:** Press Diff 144.1 Psig, Filter Diff 9.7 Psig, Inj Temp 113.7 °F, Sep Temp 110.1 °F
- Motor:** Amperage 0.0 Amps

The bottom of the screen shows a navigation bar with 'Page' 1-6 (page 4 is selected), a 'Menu' button, and a status bar with 'Maintenance', 'User Access', 'Log off', and 'Help' buttons. The status bar also indicates 'No Scheduled Maintenance', 'No Alarm/Trips Present', 'Master' status, 'User admin', '11/07/2014 18:29:27', and 'Run Hours 0'.

Figure 10-6. Compressor Sequencing Screen - Device List (Page 4)

## Section 10 • Compressor Sequencing

### VIEW DETECTED DEVICES

This pop-up is displayed when clicking the View Detected Devices button in the Device List Screen. Vision 20/20 slave devices or automatically detected devices are shown by the Master compressor as in Figure 10-7.

Device Name:

- Displays the Name of the Detected Device.

IP Address:

- Displays the IP Address of the Detected Device.

Device ID:

- Displays the Device ID of the Detected Device.

CFM:

- Displays the CFM of the Detected Device.

Add:

- Checkbox to select the Detected Device.

OK:

- This button allows the addition of Detected / Vision 20/20 devices as Slave Compressors.

The screenshot displays the 'View Detected Devices' pop-up window over the main 'Compressor Sequencing Screen'. The pop-up window contains the following table:

Device Name	IP Address	Device ID	CFM	Add
Slave 1	192.168.1.95	5	483	<input type="checkbox"/>
Slave 2	192.168.1.97	7	483	<input type="checkbox"/>
Slave 3	192.168.1.98	8	483	<input type="checkbox"/>

The background screen shows the following information:

- Suction Pressure 1:** Stopped, 6.0 Psig Δ
- Capacity Slide:** 0.0 %
- Volume Slide:** 0.0 %
- Control Panel:** Stop, Remote Lock Out, Alarm Reset, Unit Start
- Control Parameters:** on Press Control, pint 20.0 Psig, on, s 26.0 Psig, 55.0 °F, large, s 128.6 Psig, 71.2 °F, large : Suction, s Ratio 3.5, s Diff 144.3 Psig, Diff 9.7 Psig, s Amp 113.7 °F, Sep Temp 110.1 °F
- Motor Amperage:** 0.0 Amps
- Status:** No Scheduled Maintenance, No Alarm/Trips Present
- User Information:** User admin, 11/07/2014 18:15:31, Run Hours 0

Figure 10-7. Compressor Sequencing Screen - View Detected Devices (Page 4)



## Section 10 • Compressor Sequencing

### Add Device

This screen is displayed when clicking the Add Device button in the Device List Screen. A Vission device can be added as a Slave compressor by the Master compressor from this screen as shown in Figure 10-8.

Device Name:

- Entry box to set the Name of a Vission Device.

IP Address:

- Entry box to set the IP Address of a Vission Device.

Device ID:

- Entry box to set the Device ID of a Vission Device.

CFM:

- Drop-down box to set the CFM of a Vission Device.

OK:

- This button allows the addition of a Vission Device as a Slave Compressor.

The screenshot shows the 'Add Device' screen in a compressor sequencing interface. The main window is titled 'Vission Device Setup' and contains the following fields:

- Device Name:
- IP Address:
- Device ID:
- Compressor Model: 71 (dropdown menu)

Buttons for 'OK' and 'Cancel' are located at the bottom of the dialog. The background interface displays various system parameters and controls:

- Suction Pressure 1:** Stopped, 5.8 Psig Δ
- Capacity Slide:** 0.0% (with - and + buttons)
- Volume Slide:** 0.0% (with - and + buttons)
- Control Buttons:** Stop (red), Remote Lock Out (yellow), Alarm Reset (yellow), Unit Start (green)
- Suction Press Control:** Setpoint 20.0 Psig
- Suction:** Press 25.8 Psig, Temp 55.0 °F
- Discharge:** Press 128.5 Psig, Temp 71.0 °F
- Discharge : Suction:** Press Ratio 3.5
- Oil:** Press Diff 144.5 Psig, Filter Diff 9.7 Psig, Inj Temp 113.5 °F, Sep Temp 110.1 °F
- Motor:** Amperage 0.0 Amps
- Status Bar:** Maintenance, User Access, Log off, Help, Master, User admin, 11/07/2014 18:30:42, Run Hours 0, No Scheduled Maintenance, No Alarm/Trips Present

Figure 10-8. Compressor Sequencing Screen - Add Device (Page 4)

## Section 10 • Compressor Sequencing

### Delete Device

This popup is displayed when clicking the Delete Device button in the Device List Screen. Slave compressors can be removed from the sequencing network by the Master Compressor from this screen, as shown in Figure 10-9.

Yes:

- This button allows the deletion of a Slave Compressor from the Sequencing Network.

No:

- This button cancels the deletion of a Slave Compressor from the Sequencing Network.

The screenshot displays the 'Delete Device' interface. At the top, the status is 'Suction Pressure 1', 'Stopped', and '6.0 Psig Δ'. The 'Devices List' table is as follows:

Device Name	Device Type	IP Address	Device ID	CFM
Slave 1	Vission 20/20	192.168.1.95	5	483
Slave 2	Vission 20/20	192.168.1.97	7	483
Slave 3	Vission 20/20	192.168.1.98	8	483

A confirmation dialog box is shown with the text: 'Do you wish to delete device from list?' and buttons for 'Yes' and 'No'. The 'Delete Device' button in the 'Devices List' is highlighted with a dashed border.

On the right side, there are several control panels:

- Capacity Slide:** 0.0 % with minus and plus buttons, and a red 'Stop' button.
- Volume Slide:** 0.0 % with minus and plus buttons, and a yellow 'Remote Lock Out' button.
- Suction Press Control:** Setpoint 20.0 Psig.
- Suction:** Press 26.0 Psig, Temp 55.0 °F.
- Discharge:** Press 128.5 Psig, Temp 71.5 °F.
- Discharge : Suction:** Press Ratio 3.5.
- Oil:** Press Diff 144.1 Psig, Filter Diff 9.7 Psig, Inj Temp 113.1 °F, Sep Temp 110.1 °F.
- Motor:** Amperage 0.0 Amps.

At the bottom, there are navigation buttons (Page 1-6, Menu), maintenance status (No Scheduled Maintenance, No Alarm/Trips Present), and user information (Master, User admin, 11/07/2014 18:31:46, Run Hours 0).

Figure 10-9. Compressor Sequencing Screen - Delete Device (Page 4)

## Section 10 • Compressor Sequencing

### Test Connection

The Master Compressor offers an easy way to test the physical connection with the slave compressors. This can be mainly used for troubleshooting slave devices in the network. By clicking the Test Connection button, the connection result is displayed as shown in Figure 10-10.

The screenshot displays the Compressor Sequencing interface. At the top, it shows 'Suction Pressure 1' at '5.8 Psig Δ' and the compressor is 'Stopped'. A 'Devices List' table is visible, listing three slave devices. A modal dialog box in the center confirms 'Connection with device tested successfully' with an 'OK' button. The right sidebar contains control sliders for 'Capacity Slide' and 'Volume Slide', both at 0.0%, and buttons for 'Stop', 'Remote Lock Out', 'Alarm Reset', and 'Unit Start'. The bottom right section provides detailed operational data for Suction and Discharge pressures and temperatures, as well as Oil and Motor parameters.

Device Name	Device Type	IP Address	Device ID	CFM
Slave 1	Vission 20/20	192.168.1.95	5	483
Slave 2	Vission 20/20	192.168.1.97	7	483
Slave 3	Vission 20/20	192.168.1.98	8	483

Category	Parameter	Value
Suction Press Control	Setpoint	20.0 Psig
	Press	25.8 Psig
	Temp	55.0 °F
Discharge	Press	128.4 Psig
	Temp	71.2 °F
Discharge : Suction Press Ratio		3.5
Oil	Press Diff	144.2 Psig
	Filter Diff	9.8 Psig
	Inj Temp	113.7 °F
	Sep Temp	109.6 °F
Motor	Amperage	0.0 Amps

Figure 10-10. Compressor Sequencing Screen – Test Connection

## Section 10 • Compressor Sequencing

### Sync Sequencing Parameters

This screen offers the ability to sync Vission device's information with Vission 20/20 slave compressors. This feature is basically used in situations where the Vission 20/20 Compressor role needs to change from a Slave to Master. Hence operator does not require to Add Vission Devices again as Slave Compressors in the Sequencing Network. For the Sync Sequencing Parameters screen see Figure 10-11.

Sync:

- By pressing this button, the Vission device's information is sent over the network to the Vission 20/20 Slave Compressors.

### NOTE

Follow these steps to use this feature:

1. Sync Data by pressing the Sync Button in the Master compressor.
2. Change the intended Vission 20/20 Slave Compressor to Master Compressor from the Configuration Screen.
3. Log on to the Compressor Sequencing Screen to view the Vission devices in the Devices List Screen of the new Master Compressor.

Please make sure at the same time that there is only one Master in the Compressor Sequencing Network to ensure the proper working of the Compressor Sequencing Algorithm.

The screenshot shows a control interface for a compressor. At the top, it displays 'Suction Pressure 1', 'Stopped', and '6.0 Psig Δ'. The main area is divided into several sections:

- Load Balancing:** Includes a 'Load Balance' checkbox, 'Load Balancing Timer' set to '30 min', and 'Efficient Capacity' set to '60%'.
- Sync Sequencing Parameters:** Features a 'Sync Data' section with a 'Sync' button.
- Capacity Slide:** A slider set to '0.0%' with 'Stop', 'Remote Lock Out', and 'Alarm Reset' buttons.
- Volume Slide:** A slider set to '0.0%' with a 'Unit Start' button.
- Suction Press Control:** Shows 'Setpoint 20.0 Psig'.
- Suction:** Shows 'Press 26.0 Psig' and 'Temp 55.0 °F'.
- Discharge:** Shows 'Press 128.4 Psig' and 'Temp 71.0 °F'.
- Discharge : Suction:** Shows 'Press Ratio 3.5'.
- Oil:** Shows 'Press Diff 144.3 Psig', 'Filter Diff 9.7 Psig', 'Inj Temp 113.5 °F', and 'Sep Temp 109.9 °F'.
- Motor:** Shows 'Amperage 0.0 Amps'.

At the bottom, there is a navigation bar with 'Page' buttons (1-6), a 'Menu' button, and a status bar showing 'Master' and 'admin' user. The status bar also displays 'No Scheduled Maintenance', 'No Alarm/Trips Present', 'User 11/07/2014 18:34:15', and 'Run Hours 0'.

Figure 10-11. Compressor Sequencing Screen - Sync Sequencing Parameters (Page 5)

## Section 10 • Compressor Sequencing

### Compressor Sequencing Events Log

This screen is designed to display sequencing events in chronological order. The information available on the screen is valuable to understand the operation of the sequencing feature and for troubleshooting, see Figure 10-12. This screen is divided into four columns and can list up to 256 separate events. The operator can download the information on the sequencing event list through the Data Backup Screen.

Event Type:

- Displays the type of message for a particular listing. The common types are “Error”, “Alarm” and “Info”. These help the operator to understand the meaning of the message in the next column.

Message:

- Displays the informational string that describes the event.

### EVENTS LIST COLUMNS

Date:

- Displays the date of the event in MM-DD-YYYY format.

Time:

- Displays the time of the event in HH:MM:SS format.

The screenshot displays the Compressor Sequencing Events Log interface. At the top, a green header shows 'Suction Pressure 1', 'Auto Sequencing', and '-3.4 Psig Δ'. Below this is a table with columns for Date, Time, Event Type, and Message. The table lists several events from 11-21-2014, including 'Stopped Slave Compressor' and 'Start Slave Compressor' for various slave units. To the right of the table are control sliders for 'Capacity Slide' (0.0%) and 'Volume Slide' (68.4%), along with buttons for 'Stop', 'Remote Lock Out', 'Alarm Reset', and 'Unit Start'. Below the sliders are sections for 'Suction Press Control' (Setpoint 20.0 Psig), 'Suction' (Press 16.6 Psig, Temp 36.3 °F), 'Discharge' (Press 125.7 Psig, Temp 94.1 °F), and 'Discharge : Suction Press Ratio 4.5'. At the bottom, there are buttons for 'Maintenance', 'User Access', 'Log off', and 'Help', along with a 'Master' status indicator. The bottom right corner shows 'Oil' (Press Diff 153.0 Psig, Filter Diff 9.9 Psig, Inj Temp 117.4 °F, Sep Temp 110.5 °F) and 'Motor' (Amperage 1.2 Amps) status. The bottom left corner shows 'No Scheduled Maintenance' and 'No Alarm/Trips Present'. The bottom center shows 'User admin', '11/21/2014 10:36:07', and 'Run Hours 0'.

Date	Time	Event Type	Message
11-21-2014	10:27:01 AM	Info	Stopped Slave Compressor : Slave 1
11-21-2014	10:22:22 AM	Info	Stopped Slave Compressor : Slave 2
11-21-2014	10:19:18 AM	Info	Stopped Slave Compressor : Slave 3
11-21-2014	10:10:21 AM	Info	Start Slave Compressor : Slave 3
11-21-2014	10:07:41 AM	Info	Start Slave Compressor : Slave 2
11-21-2014	10:04:20 AM	Info	Start Slave Compressor : Slave 1
11-21-2014	10:02:22 AM	Info	Stopped Slave Compressor : Slave 1
11-21-2014	09:59:20 AM	Info	Start Slave Compressor : Slave 1

Figure 10-12. Compressor Sequencing Screen - Events Log (Page 5)

## Section 10 • Compressor Sequencing

### Configuration Overview

#### NOTE

Slave Compressors should be configured first, and then configure the Master Compressor.

The Configuration screen allows the operator to:

- Enable / Disable Compressor Sequencing
- Select Slave / Master Mode of operation for the compressor
- Assign a unique compressor name
- Enable Ethernet port
- Select Modbus TCP protocol
- Assign a unique Ethernet IP address

### SETTING UP THE SLAVE COMPRESSORS FOR SEQUENCING

1. Log onto each of the slave compressors one by one and navigate to the Configuration screen, see Figure 10-13.
2. Enable the Ethernet port and select the Modbus TCP protocol.
3. Set up a unique Ethernet IP address for each slave.
4. Set up the Subnet Mask for the IP address.
5. Set up the Gateway address (MUST DO!)
6. Enable the sequencing in slave mode.
7. Select a Network Name for sequencing.
8. Select a Unique Name for each slave compressor.
9. Set the Communications Active Remote Control to “ETHERNET” for each slave compressor.
10. Apply these settings before exiting the Configuration screen.

**Compressor Identification**

Name:

Panel ID:

Temp. Units:

Press. Units:

Order Num.:

Run Hours:

**Time**

Format

24 hour

12 hour

Current

Hour:

Minute:

Second:

**Date**

Year:

Month:

Day:

**Communications**

Active Remote Control:

**On Communication Failure**

Direct I/O

Run Permissive

Serial (Modbus RTU)

Node Address:

Port:

Baud Rate:

Data Bits:  8

Stop Bits:  1  2

Parity:

Ethernet

IP Address:

Subnet Mask:

Gateway:

Protocol:

Node Address:

**VNC Account**

New Password:

Verify New Password:

Port Number:

Enable Web Browser Access

Browser Port Number:

**Anti-Recycle**

**Restart on Power Failure**

Always

Never

Timed

Remote Lock Off

Boot in Remote (Direct I/O)

Compressor Sequencing

Master

Slave

Network Name:

**Language**

Page:

Figure 10-13. Compressor Setup for Compressor Sequencing (Slave)

## Section 10 • Compressor Sequencing

At this point the slave compressor will begin multicasting its status information over the network at a rate of every 15 seconds. (After the Master Compressor is configured, the slave information will be populated in the Sequencing menu of the Master Compressor)

- Exit out of the configuration screen and then put the slave in Remote mode by pressing Unit Start->Remote, see Figure 10-14.

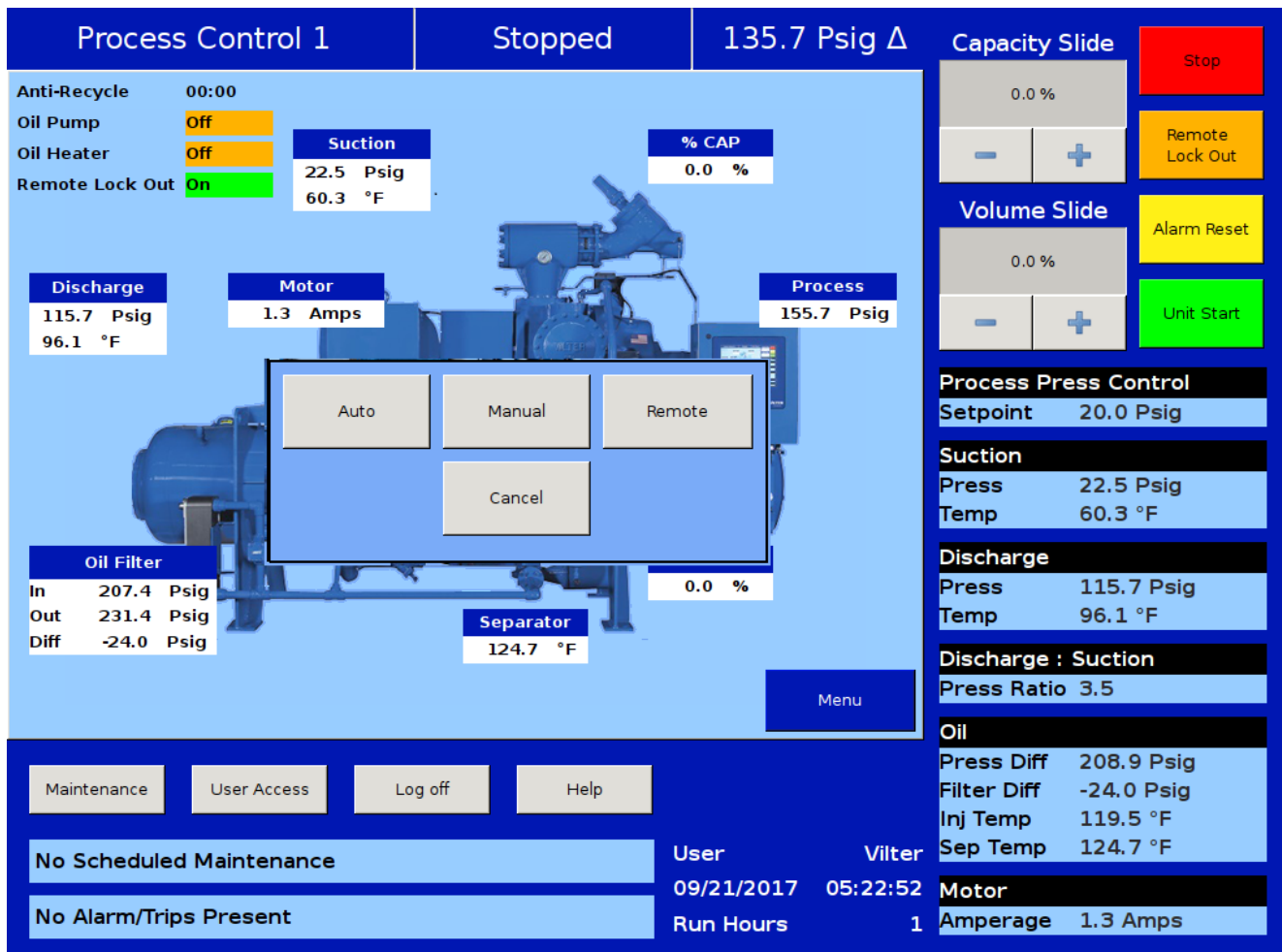

Figure 10-14. Placing Slave Compressors into Remote Mode

## Section 10 • Compressor Sequencing

### SETTING UP THE MASTER COMPRESSOR

#### NOTE

The master compressor will ALWAYS be the highest priority compressor – and act as the trim compressor. So this must be taken into account when deciding which compressor is to act as the master compressor.

Log onto the master compressor and navigate to the Configuration screen, see Figure 10-15.

1. Enable the Ethernet port and select the Modbus TCP protocol.
2. Setup a unique Ethernet IP address for the master.
3. Setup the Subnet Mask for the IP address.
4. Setup the Gateway address. (MUST DO!)
5. Enable the Compressor Sequencing check box and select “Master”.
6. Select a Network Name for the master compressor.

(Network Name must be same for Master & Slave Compressors)

7. Select a Unique Name for the master compressor.
8. Set the Communications Active Remote Control to “ETHERNET”.
9. Apply these settings before exiting the Configuration screen.

At this point, the master will begin receiving the slave compressors information from the network and will populate it in the View Detected Devices pop-up of the Compressor Sequencing screen. If after a couple of minutes you do not see the slave compressors listed under the View Detected Devices list, then power cycle the master compressor panel.

**Compressor Identification**

Name:

Panel ID:

Temp. Units:

Press. Units:

Order Num.:

Run Hours:

**Time**

Format

24 hour

12 hour

Current

Hour:

Minute:

Second:

**Date**

Year:

Month:

Day:

**Communications**

Active Remote Control:

**On Communication Failure**

Direct I/O

Run Permissive

Serial (Modbus RTU)

Node Address:

Port:

Baud Rate:

Data Bits:  8

Stop Bits:  1  2

Parity:

Ethernet

IP Address:

Subnet Mask:

Gateway:

Protocol:

Node Address:

**VNC Account**

New Password:

Verify New Password:

Port Number:

Enable Web Browser Access

Browser Port Number:

**Anti-Recycle**

Hot Starts:

**Restart on Power Failure**

Always

Never

Timed

Remote Lock Off

Boot in Remote (Direct I/O)

Compressor Sequencing

Master

Slave

Network Name:

**Language**

English:

Page:

Apply Close

Figure 10-15. Compressor Setup for Compressor Sequencing Master



# Section 11 • Condenser Control

## Overview

This screen allows the operator to view and adjust condenser setpoint settings associated with condenser operation. This screen will only be active if the Condenser Control option has been enabled from the Configuration Screen, page 2. When Condenser Control is running, a status icon will appear on the bottom left corner of the main screen to make the user aware of it.

The Condenser Control operation allows the cycling of fans and pumps in order to maintain a specific condensing pressure. The five different steps in step control allow selection of fans, pumps and VFD in one or more steps. When a VFD is employed, VFD is allowed to reach maximum speed, if additional capacity is needed, the next fan or pump is turned on. The VFD will modulate down and then once it is back up to 100% again, then the next fan or pump is turned on. This method allows the smoothest condenser control by spacing the VFD between the fan and pump steps, while maintaining a condenser pressure that matches the setpoint.

## Condenser Control Setpoint:

Run Mode:

- Run Mode allows the selection of different modes of operation for condenser control. The choices for selection are:

Run Never

- The mode of operation by default. Condenser Control operation will not be performed when this mode is active.

Run With Comp

- Automatic operation of condenser control selected when control of the condenser is required to only run when the compressor is running.

Run Always

- Automatic operation of condenser control selected when control of the condenser is required to run even when the compressor is off.

**Suction Pressure 1**      **Stopped**      **6.1 Psig Δ**

**Run Mode**

- Run Never
- Run With Comp
- Run Always
- Manual

Condenser Press: 126.1 Psig      Ambient Temp: 0.0 °F

Condenser Setpoint: 120.0 Psig      Wetbulb Temp: 0.0 °F

Upper Deadband: 5.0 Psig      Wetbulb Offset: 5.0 °F

Lower Deadband: 5.0 Psig      Switch Temp: 32.0 °F

Profile: Summer       Summer/Winter Auto Switch

High to Low Speed Fan Delay: 15 sec       Wetbulb Override

Steps	Out #1	Out #2	Out #3	Out #4	VFD	Step Delay	Low Speed Fan	Control
<input type="checkbox"/> Step 1	<input type="checkbox"/>	<input type="checkbox"/>	<input type="checkbox"/>	<input type="checkbox"/>	<input type="checkbox"/>	15 sec	None	OFF
<input type="checkbox"/> Step 2	<input type="checkbox"/>	<input type="checkbox"/>	<input type="checkbox"/>	<input type="checkbox"/>	<input type="checkbox"/>	15 sec	None	OFF
<input type="checkbox"/> Step 3	<input type="checkbox"/>	<input type="checkbox"/>	<input type="checkbox"/>	<input type="checkbox"/>	<input type="checkbox"/>	15 sec	None	OFF
<input type="checkbox"/> Step 4	<input type="checkbox"/>	<input type="checkbox"/>	<input type="checkbox"/>	<input type="checkbox"/>	<input type="checkbox"/>	15 sec	None	OFF
<input type="checkbox"/> Step 5	<input type="checkbox"/>	<input type="checkbox"/>	<input type="checkbox"/>	<input type="checkbox"/>	<input type="checkbox"/>	15 sec	None	OFF

**Capacity Slide**      0.0 %      **Stop**

**Volume Slide**      0.0 %      **Remote Lock Out**

**Suction Press Control**

Setpoint: 20.0 Psig

**Suction**

Press: 26.1 Psig

Temp: 55.0 °F

**Discharge**

Press: 128.5 Psig

Temp: 71.2 °F

**Discharge : Suction**

Press Ratio: 3.5

**Oil**

Press Diff: 144.3 Psig

Filter Diff: 9.5 Psig

Inj Temp: 113.3 °F

Sep Temp: 109.4 °F

**Motor**

Amperage: 0.0 Amps

Page: 1      2      Menu

Maintenance      User Access      Log off      Help      Panel 1

No Scheduled Maintenance      User: admin

No Alarm/Trips Present      11/07/2014 13:10:03

Run Hours: 0

Figure 11-1. Condenser Control Screen - Page 1

## Section 11 • Condenser Control

---

### Manual:

- Mode for controlling condenser operation manually. Operator controls the operation by manual stepping using an on/off toggle button at each step.

### Condenser Press:

- This is a read only parameter and it displays the present value of condenser pressure.

### Condenser Setpoint:

- This is the condenser pressure setpoint that needs to be maintained.

### Upper Deadband:

- This is the condenser pressure setpoint, upper deadband value. No additional condenser capacity is added when the condenser is selected for automatic step control and the condenser pressure falls within this deadband.

### Lower Deadband:

- This is the condenser pressure setpoint, lower deadband value. Condenser capacity is not reduced when the condenser is selected for automatic step control and the condenser pressure falls within this deadband.

### Ambient Temp:

- This is a read-only parameter and it displays the present value of ambient temperature. This is displayed only when Ambient Sensor is enabled from Configuration Screen.

### Wetbulb Temp:

- This is a read-only parameter and it displays the present value of wetbulb temperature. This is displayed only when Wetbulb Sensor is enabled from Configuration Screen.

### Wetbulb Offset:

- This is the offset value from wetbulb temperature as the override point.

### Switch Temp:

- This is the ambient temperature setpoint used for automatic switching of profile from summer to winter and vice-versa.

### Profile Selection:

- Profile selection allows operator to have two different output profiles for summer and winter. Operator can have different selection of fans, pumps & VFD in five steps of step control table. Different profiles allow inclusion/exclusion of water pumps in cold weather when summer/winter auto switch is enabled. This selection is inactive when Run mode is Auto and Summer/Winter Auto Switch is enabled.

### High to Low Speed Fan Delay:

- This is a time delay for the fan spin down in case of 2- speed motor/dual speed fan.

### Summer/Winter Auto Switch:

- This checkbox, when enabled, allows profiles to switch automatically depending on the ambient temperature setpoint when Run Mode is "Auto". When ambient temperature falls below the ambient temperature setpoint, winter profile is used. Similarly when ambient temperature is above the ambient temperature setpoint, summer profile is used.

### Wetbulb Override:

- This checkbox, when enabled, gives the operator a functionality to control energy wastage. When the condenser temperature reaches wetbulb temperature plus the operator given offset, then the condenser control operation does not add additional steps. This is done as it is not possible to lower the temperature anymore, and by adding more fans or pumps controls the operation by manually stepping using an on/off toggle button at each step.

## Step Control

The Step Control allows the operator to setup the manner in which Fans, Pumps & VFD will be turned on/off. Fans & Pumps are connected on digital outputs Out #1 to Out #4. VFD Fan is connected on Analog Output. Each step can have a maximum of five outputs connected to it. Each step can be opted in or out depending on enabling of checkbox.

When Run Mode is Auto and condenser pressure rises above the upper deadband, the condenser step increments from Step 1 up to Step 5 and hence switching on/off Pumps, Fans & VFD connected on outputs. This holds true when decreasing steps from Step 5 to Step 1 when condenser pressure falls below the lower deadband.

### Step Delay:

- Allows operator to set time delays between condenser steps. Condenser Pressure must be outside upper or lower deadband continuously for delay time in order to increase or decrease condenser steps. While in a VFD step, an additional step can only be added once VFD has reached its maximum speed setpoint and the delay timers are satisfied.
- Similarly in a VFD step, a step can only be removed once VFD has reached its minimum speed setpoint and the delay timers are satisfied. Step Delay acts as "ON" timer while loading and acts as "OFF" timer

## Section 11 • Condenser Control

---

while unloading for the same step.

Low Speed Fan:

- Allows steps to have option for time delay in case of fan spin down. Any of Out #1 to Out #4 can be selected as Low Speed Fan through combo box. E.g.: Let's say Out #2 is selected as Low Speed Fan in Step 2. When step 2 becomes active during condenser control operation which is after Step 2 time-out delay, Out #2 is left off for time as set by the operator in High to Low Speed Delay. After low speed fan energizes, then timer for Step 3 starts timing.

Control:

- Toggle any of the steps On/Off during Manual operation of Condenser Control. This button is active only when Run Mode selected is Manual. During Auto operation of Condenser Control, control button for active step will be "ON".

### VFD Settings

This page is active only when Condenser VFD is selected in the Configuration Screen, see Section 19. For VFD controls refer to Figure 11-2. When a VFD Fan is used for condenser control operation, the speed of the VFD is controlled using PID algorithm.

P = Proportional (gain):

- Used to adjust the fan speed action in direct proportion to the difference between the control setpoint and the process variable ( $SP - PV = \text{error}$ ). The proportional term is a unitless quantity and is used for coarse adjustment. This setpoint should be set to the lowest value that gives adequate control system response. Increasing the proportional setting increases the control system's sensitivity to small process fluctuations and the tendency to hunt.

I = Integral (reset):

- Used to adjust the capacity control action, integrating the error over time, to account for a small error that has persisted for a long time. This quantity is used for fine adjustment. This setpoint is used to smooth out process variations. This setpoint should be set high enough to prevent hunting but not too high or it will cause control system overshoot.

D = Derivative (rate):

- Used to adjust the capacity control action, accounting for how fast the error is changing, positively or negatively.

Maximum Speed:

- This setpoint defines the maximum speed in percentage for Condenser VFD Fan at which it should run for continuous step delay time to increase condenser steps. E.g. let's say setpoint is kept at 95%. Then condenser VFD fan will have to run at speed of 95% or more to advance to next step. Maximum Speed can be set as 100%, which is when analog output (at which condenser VFD fan is connected) reaches to 20mA in its normal range of 4-20 mA

Minimum Speed:

- This setpoint defines the minimum speed in percentage for Condenser VFD Fan at which it should run for continuous step delay time to decrease condenser steps. E.g. let's say setpoint is kept at 5%. Then condenser VFD fan will have to run at speed 5% or less to advance to next step. Minimum Speed can be set as 0%, which is when analog output (at which condenser VFD fan is connected) reaches 4mA in its normal range of 4-20 mA.

# Section 11 • Condenser Control

Suction Pressure 1
Stopped
6.0 Psig  $\Delta$

Setpoint

### VFD Settings

P  Minimum Speed

I  Maximum Speed

D

Max Limit

Min Limit

Capacity Slide

0.0 %

-    +

Volume Slide

0.0 %

**Stop**

Remote Lock Out

Alarm Reset

Unit Start

**Suction Press Control**

Setpoint 20.0 Psig

**Suction**

Press 26.0 Psig

Temp 54.6 °F

**Discharge**

Press 128.5 Psig

Temp 71.7 °F

**Discharge : Suction**

Press Ratio 3.5

**Oil**

Press Diff 144.2 Psig

Filter Diff 9.8 Psig

Inj Temp 113.1 °F

Sep Temp 109.6 °F

**Motor**

Amperage 0.0 Amps

Page 1 2
Menu

Maintenance    User Access    Log off    Help

**No Scheduled Maintenance**

**No Alarm/Trips Present**

Panel 1

User admin

11/07/2014 13:12:34

Run Hours 0

Figure 11-2. Condenser Control Screen - Page 2

## Section 12 • Service Options

### Overview

The Service Option screen allows the operator the ability to force individual digital or analog outputs ON. This feature is used for diagnostic purposes during initial setup and/or if the operator suspects an issue with the outputs. The buttons in this screen are not available while the compressor is running.

### Digital Outputs

The digital output buttons are momentary toggle buttons. The output will be active while the operator has his finger on the button. The output will deactivate when the operators finger is removed. The operator can measure the output at the terminal block or view the output by watching the LEDs located on the cards. For Digital Output screens, see Figures 12-1, 12-2, 12-3 and 12-4.

Reference Figure 12-1.

Compressor Start:

- Activates the output assigned to the compressor motor starter. The output is connected to terminal 11 and is the 1st LED on card 1.

Oil Pump Start:

- Activates the output assigned to the oil pump. The output is connected to terminal 12 and is the 2nd LED down on card 1.

Capacity Increase Motor:

- Activates the output assigned to the increase input of the capacity actuator. The output is connected to terminal 13 and is the 3rd LED down on card 1.

Capacity Decrease Motor:

- Activates the output assigned to the decrease input of the capacity actuator. The output is connected to terminal 14 and is the 4th LED down on card 1.

The screenshot shows the 'Digital Outputs' section with the following controls:

Output Name	Status
Compressor Start	OFF
Oil Pump Start	OFF
Capacity Increase	OFF
Capacity Decrease	OFF
Volume Increase	OFF
Volume Decrease	OFF
Oil Separator Heater	OFF
Trip	ON

Additional controls and parameters on the right side of the screen:

- Capacity Slide:** 0.0 %
- Volume Slide:** 0.0 %
- Suction Press Control:** Setpoint 20.0 Psig
- Suction:** Press 26.1 Psig, Temp 55.2 °F
- Discharge:** Press 123.8 Psig, Temp 71.0 °F
- Discharge : Suction:** Press Ratio 3.4
- Oil:** Press Diff 46.0 Psig, Filter Diff 10.0 Psig, Inj Temp 114.9 °F, Sep Temp 110.5 °F
- Motor:** Amperage 0.0 Amps

Navigation and status elements at the bottom include: Page 1, Maintenance, User Access, Log off, Help, Panel 1, User admin, 11/07/2014 15:57:10, Run Hours 0, No Scheduled Maintenance, and No Alarm/Trips Present.

Figure 12-1. Service Options Screen - Digital Outputs (Page 1)

## Section 12 • Service Options

### Volume Increase Motor:

- Activates the output assigned to the increase input of the volume actuator. The output is connected to terminal 15 and is the 5th LED down on card 1.

### Volume Decrease Motor:

- Activates the output assigned to the decrease input of the volume actuator. The output is connected to terminal 16 and is the 6th LED down on card 1.

### Oil Separator Heater

- Activates the output assigned to the oil separator heater. The output is connected to terminal 17 and is the 7th LED down on card 1.

### Trip:

- Deactivates the output during a trip or inhibit condition. This is a inverse acting output. The output is connected to terminal 18 and is the bottom LED on card 1.

Reference Figure 12-2.

### Slide Valve Setpoint # 1 (Economizer):

- Activates the output typically assigned to the economizer solenoid, but can be changed by the operator. The output is connected to terminal 21 and is the 1st LED on card 2.

### Slide Valve Setpoint # 2 (Hot Gas Bypass):

- Activates the output typically assigned to the hot gas bypass solenoid, but can be changed by the operator. The output is connected to terminal 22 and is the 2nd LED on card 2.

### Alarm:

- Activates the output during an alarm condition. This is a inverse acting output. The output is connected to terminal 23 and is the 3rd LED on card 2.

### Economizer Port # 2 :

- Activates the output typically assigned to the economizer solenoid. The output is connected to terminal 24 and is the 4th LED down on card 2.

The screenshot shows a control interface with a blue header and a light blue main area. The header displays 'Suction Pressure 1', 'Stopped', and '6.3 Psig Δ'. The main area is titled 'Digital Outputs' and contains a table of outputs with their status:

Output Name	Status
Slide Valve Setpoint #1	OFF
Slide Valve Setpoint #2	OFF
Alarm	ON
Economizer Port #2	OFF
Liquid Injection #1	OFF
Liquid Injection #2	OFF
Remote Enabled	OFF
Emergency Output	OFF

On the right side, there are several control panels:

- Capacity Slide:** 0.0% with minus and plus buttons, a red 'Stop' button, and a yellow 'Remote Lock Out' button.
- Volume Slide:** 0.0% with minus and plus buttons, a yellow 'Alarm Reset' button, and a green 'Unit Start' button.
- Suction Press Control:** Setpoint 20.0 Psig.
- Suction:** Press 26.3 Psig, Temp 55.2 °F.
- Discharge:** Press 124.0 Psig, Temp 71.5 °F.
- Discharge : Suction:** Press Ratio 3.4.
- Oil:** Press Diff 46.1 Psig, Filter Diff 9.8 Psig, Inj Temp 114.7 °F, Sep Temp 110.5 °F.
- Motor:** Amperage 0.0 Amps.

At the bottom, there are navigation buttons (Page 1, 2, 3, 4, Menu), system status (Maintenance, User Access, Log off, Help), and user information (Panel 1, User admin, 11/07/2014 15:57:59, Run Hours 0). Status messages include 'No Scheduled Maintenance' and 'No Alarm/Trips Present'.

Figure 12-2. Service Options Screen - Digital Outputs (Page 2)

## Section 12 • Service Options

### Liquid Injection # 1:

- Activates the output assigned to the liquid injection solenoid. The output is connected on terminal 25 and is the 5th LED on card 2.

### Liquid Injection # 2:

- Activates the output assigned to the liquid injection solenoid. The output is connected on terminal 26 and is the 6th LED on card 2.

### Remote Enabled:

- Activates the output assigned to notify a central control system of the Vission 20/20 running status. The output is connected to terminal 27 and is the 7th LED on card 2.

### Shunt Trip:

- Activates the output during a false start condition when the emergency stop timer has expired. This output could be wired to a breaker with a shunt trip that feeds power to a starter to force a shutdown.

The output is connected to terminal 28 and is the 8th LED on card 2.

Reference Figure 12-3 and Figure 12-4.

### Condenser / Remote Oil Cooler Step # 1:

- Activates the output assigned to the 1st step of the Condenser / Remote Oil Cooler. The output is connected to terminal 41 and is the 1st LED on card 4.

### Condenser / Remote Oil Cooler Step # 2:

- Activates the output assigned to the 2nd step of the Condenser / Remote Oil Cooler. The output is connected to terminal 42 and is the 2nd LED down on card 4.

### Condenser / Remote Oil Cooler Step # 3:

- Activates the output assigned to the 3rd step of the Condenser / Remote Oil Cooler. The output is connected to terminal 43 and is the 3rd LED down on card 4.

The screenshot shows a control interface for a Vission 20/20 system. The top status bar indicates 'Suction Pressure 1', 'Stopped', and '6.5 Psig Δ'. The main 'Digital Outputs' section lists eight outputs, all of which are currently 'OFF'. On the right side, there are two sliders: 'Capacity Slide' at 0.0% and 'Volume Slide' at 0.0%. Below these are several control panels: 'Suction Press Control' with a setpoint of 20.0 Psig; 'Suction' parameters (Press 26.5 Psig, Temp 55.0 °F); 'Discharge' parameters (Press 124.0 Psig, Temp 71.5 °F); 'Discharge : Suction Press Ratio' at 3.4; 'Oil' parameters (Press Diff 46.2 Psig, Filter Diff 9.7 Psig, Inj Temp 115.3 °F, Sep Temp 110.1 °F); and 'Motor' parameters (Amperage 0.0 Amps). The bottom navigation bar includes buttons for 'Maintenance', 'User Access', 'Log off', and 'Help', along with a 'Menu' button. The bottom right corner displays 'Panel 1', user 'admin', date '11/07/2014', time '15:59:25', and 'Run Hours 0'. Two status messages are shown: 'No Scheduled Maintenance' and 'No Alarm/Trips Present'.

Figure 12-3. Service Options Screen - Digital Outputs (Page 3)

## Section 12 • Service Options

Condenser / Remote Oil Cooler Step # 4:

- Activates the output assigned to the 4th step of the Condenser / Remote Oil Cooler. The output is connected to terminal 44 and is the 4th LED down on card 4.

The screenshot displays the 'Service Options' screen for the Remote Oil Cooler. The main area is titled 'Digital Outputs' and shows a table of outputs, all of which are currently 'OFF'. The table includes Remote Oil Cooler Steps #1 through #4, and Digital Aux outputs 1 through 4. The status of each output is shown in a button labeled 'OFF'. Above the table, the system is labeled 'Suction Pressure 1', 'Stopped', and '6.5 Psig Δ'. To the right of the table are several control panels: 'Capacity Slide' (0.0%), 'Volume Slide' (0.0%), 'Suction Press Control' (Setpoint 20.0 Psig), 'Discharge' (Press 123.8 Psig, Temp 71.0 °F), 'Oil' (Press Diff 46.0 Psig, Filter Diff 9.7 Psig, Inj Temp 114.4 °F, Sep Temp 109.6 °F), and 'Motor' (Amperage 0.0 Amps). At the bottom, there are navigation buttons (Maintenance, User Access, Log off, Help), a 'Panel 1' label, and system status information (User: admin, Date/Time: 11/07/2014 16:02:45, Run Hours: 0). A 'Menu' button is also present.

Output Name	Status
Remote Oil Cooler Step #1	OFF
Remote Oil Cooler Step #2	OFF
Remote Oil Cooler Step #3	OFF
Remote Oil Cooler Step #4	OFF
Digital Aux out 1	OFF
Digital Aux out 2	OFF
Digital Aux out 3	OFF
Digital Aux out 4	OFF

Figure 12-4. Service Options Screen - Digital Outputs for Remote Oil Cooler (Page 3)



## Section 12 • Service Options

### Analog Outputs

The Analog Output (AO) selections allow the operator to enter a desired value of the output then turn on the output, see Figure 12-5. The operator will have to measure the output using a meter capable of measuring a 4-20mA signal.

Compressor VFD:

- Sets the analog output assigned to the compressor VFD. The output is connected to AO #1 on card 10.

Condenser / Remote Oil Cooler VFD:

- Sets the analog output assigned to the Condenser / Remote Oil Cooler VFD. The output is connected to AO #2 on card 10.

% Slide Valve Position

- Sets the analog output assigned to the Slide Valve position used to inform a central control system of the capacity position. The output is connected to AO #3 on card 10.

Liquid injection Motorized Valve:

- Sets the analog output assigned to the liquid injection motorized valve position. The output is connected to AO #4 on card 10.

**Suction Pressure 1**      **Stopped**      **6.5 Psig Δ**

### Analog Outputs

	Value	Status
Compressor VFD	0 %	OFF
Condenser VFD	0 %	OFF
% Slide Valve Position	0 %	OFF
Liquid Injection Motorized Valve	0 %	OFF
Analog Aux out 1	0 %	OFF
Analog Aux out 2	0 %	OFF
Analog Aux out 3	0 %	OFF
Analog Aux out 4	0 %	OFF

Page: 1 2 3 **4** Menu

Maintenance User Access Log off Help      **Panel 1**

**No Scheduled Maintenance**      User: admin  
**No Alarm/Trips Present**      11/07/2014 16:00:48  
Run Hours: 0

**Capacity Slide** 0.0 %      Stop  
- +      Remote Lock Out

**Volume Slide** 0.0 %      Alarm Reset  
Unit Start

**Suction Press Control**  
Setpoint 20.0 Psig

**Suction**  
Press 26.5 Psig  
Temp 54.8 °F

**Discharge**  
Press 124.2 Psig  
Temp 70.8 °F

**Discharge : Suction**  
Press Ratio 3.4

**Oil**  
Press Diff 46.0 Psig  
Filter Diff 9.7 Psig  
Inj Temp 115.6 °F  
Sep Temp 110.3 °F

**Motor**  
Amperage 0.0 Amps

Figure 12-5. Service Options Screen - Analog Outputs (Page 4)

## Section 13 • Instruments Calibration

### Overview

The Instrument Calibration screen allows the operator to define how the Vission 20/20 will interpret the signal from any devices attached to the panel's analog inputs. The instrument calibration screen is organized in up to six pages. Each page is then divided into several left side selected tabs. Each tab will be headed with an information bar labeled "I/O" that gives the basic information for that device. The "A/D bit Value" display box shows the unmodified value read by the Vission 20/20 analog to digital converters. This display box is not affected by any changes to the calibrations settings. As long as a device is connected to the associated input, there will be a value in this display box. The "Calibrated Value" display box shows the end result of the calibration process. Therefore, any changes to the calibration setpoint will effect what value is shown.

All instruments are calibrated using a two point linear calibration process. Any device that has a non-linear response to environmental stimuli will not be able to be calibrated through the Vission 20/20.

### Pressure and Temperature Inputs

The most commonly used instruments are temperature and pressure sensors. The first two pages of the Instrument Calibration screen are dedicated to these instruments; see Figures 13-1 and 13-2.

Each tab on these two pages is divided into two sections, Device Calibration and Channel Calibration. The device calibration section is where the operation parameters of the instrument are defined. The channel calibration defines the type of signal sent by the instrument.

Default Devices:

- By selecting this option, the operator will have access via a drop-down box to several common devices. The devices are predefined and if one is selected, then all the setpoints will be set for the operator.

Custom Device:

- This option allows the operator to choose the minimum and maximum value of the instrument being used.

The screenshot shows the 'Analog Inputs' section for 'Suction Pressure 1'. The 'I/O' bar shows 'A/D bit Value' as 1139 and 'Calibrated Value' as 26.5 Psig. The 'Device Calibration' section is set to 'Default Devices' with a dropdown menu showing '0-414.5 psia (4-20ma)'. The 'Channel Calibration' section includes 'Offset' (Adjustment: 0.0, Total Offset: 0.0), 'Range' (I/O jumpers selection: 4ma - 20ma), and 'Min/Max' values (4.0 ma / 20.0 ma). On the right, there are 'Capacity Slide' and 'Volume Slide' controls, both at 0.0%, and buttons for 'Stop', 'Remote Lock Out', 'Alarm Reset', and 'Unit Start'. The 'Suction Press Control' section shows a 'Setpoint' of 20.0 Psig. Below this, 'Suction' and 'Discharge' status are shown: Suction Press 26.6 Psig, Temp 55.2 °F; Discharge Press 124.2 Psig, Temp 71.7 °F. The 'Discharge : Suction Press Ratio' is 3.4. The bottom status bar shows 'Oil' (Press Diff 46.0 Psig, Filter Diff 9.8 Psig, Inj Temp 115.1 °F, Sep Temp 110.5 °F) and 'Motor' (Amperage 0.0 Amps). Navigation buttons for 'Page 1-6' and 'Menu' are visible, along with 'Maintenance', 'User Access', 'Log off', and 'Help' buttons.

Figure 13-1. Instruments Calibration Screen - Analog Inputs (Page 1)

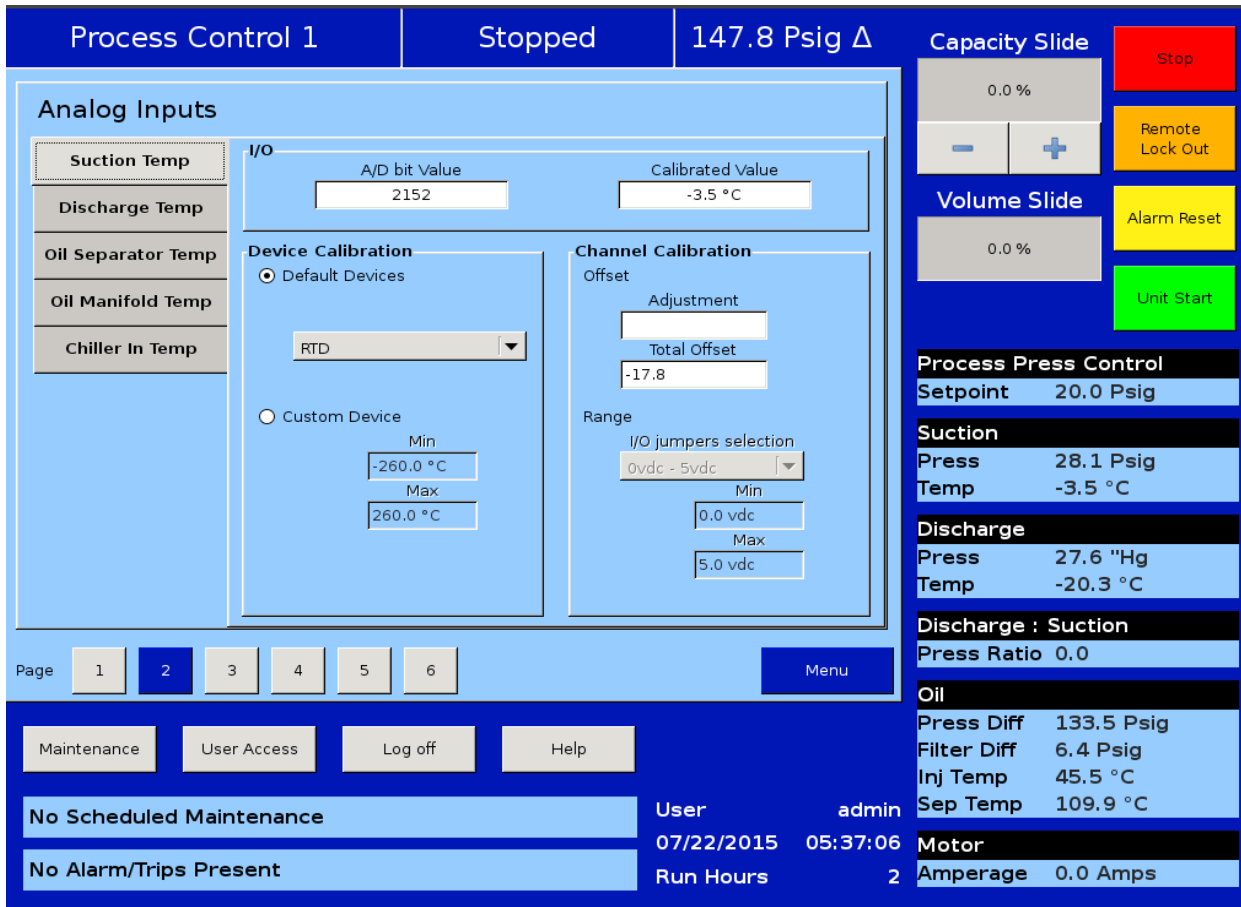

Figure 13-2. Instruments Calibration Screen - Analog Inputs (Page 2)

Offset:

- Once the two point calibration is completed, it is not uncommon for a small error to exist. By entering the value of the error from the calibrated value and the actual value into the adjustment entry box, that error will be added/subtracted from the total offset. The offset is applied to the calibrated value which should correct the error.

Range:

- This option is available when the custom device option is chosen. Here the operator defines the signal type and range transmitted by the instrument. The operator can choose from several predefined ranges in the drop-down box or enter a value.

## Process Control Inputs

Page three of the Instrument Calibration screen is dedicated to instruments used for Process Control; see Figures 13-3 and 13-4.

The Process Control tab on this page will display either Temperature or Pressure depending on the

selected control model. The tab is divided into two sections, Device Calibration and Channel Calibration with Default and Custom Devices as well as Offset and Range Calibration features as described for the standard Pressure and Temperature Inputs.

## Motor Current

The Vision 20/20 has two options for measuring motor current. A 4-20mA signal transmitted from an external device or a 0-5Amp AC current Transformer. The type of device being used is selected in the Configuration Screen, an Motor Current Device in Section 19.

The motor current tab has the ability to calibrate both measurement options through the 4-20mA scale and current transformer ratio sections, see Figure 13-5. Instruments Calibration Screen - Analog Inputs (Page 3). However, the type of device that is selected in the configuration screen will be the only section available to the operator.

The calibration differs from all other calibration procedures in that the motor current must be calibrated while the compressor is running at close to full load amps as

## Section 13 • Instruments Calibration

much as possible. In addition, the operator will need to enter a value into the “Enter Desired Value” entry box that is equal to the measured value in amps by a calibrating measurement device. After entering the measured value, the displayed motor current may still be off slightly. In this case re-enter the desired value and the displayed value should get progressively closer.

### 4-20mA Scale:

- 4mA:
  - Not editable by the operator. Defines the minimum value in amps represented by a 4mA input.
- 20mA:
  - Defines the maximum value in amps represented by a 20mA input.
- Enter Desired Value:
  - The operator enters the correct current value. Each entry will recalculate the point-slope calculations of the current calibration.
- Total Error:
  - Not editable by the operator. Displays the total error offset of the entries from the “Enter Desired Value” setpoint.

### Current Transformer Ratio:

- Primary
  - Defines the upper value of the current transformer.
- Secondary:
  - Not editable by the operator. Defines the minimum value of the current transformer.
- Enter Desired Value:
  - The operator enters the value of the correct current value. Each entry will recalculate the point-slope calculations of the current calibration.
- Total Error:
  - Not editable by the operator. Displays the total error offset of entries from the “Enter Desired Value” setpoint.

The screenshot shows a control interface for process temperature calibration. At the top, it indicates 'Suction Pressure 1' is 'Stopped' at '23.9 Psig Δ'. The main area is titled 'Analog Inputs' and contains several calibration sections:

- Motor Current:** Remote Capacity %
- Process Temp:** I/O A/D bit Value (2137), Calibrated Value (22.3 °F)
- Device Calibration:** Default Devices selected, RTD selected, Min: -436.0 °F, Max: 500.0 °F
- Channel Calibration:** Offset: 0.0, Range: 0vdc - 5vdc

On the right side, there are control slides for Capacity (0.1%) and Volume (0.0%), along with buttons for Stop, Remote Lock Out, Alarm Reset, and Unit Start. Below these are sections for Suction Press Control (Setpoint: 20.0 Psig), Suction (Press: 43.9 Psig, Temp: 27.1 °F), Discharge (Press: 177.9 Psig, Temp: -3.5 °F), and Discharge : Suction Press Ratio (3.3). The bottom of the screen shows system status: Maintenance (No Scheduled Maintenance), Alarm/Trips (No Alarm/Trips Present), User (admin), Date (07/15/2015), Time (11:33:43), Run Hours (0), and Motor Amperage (0.0 Amps).

Figure 13-3. Instruments Calibration Screen - Process Temperature (Page 3)

# Section 13 • Instruments Calibration

**Process Control 1** | **Stopped** | **123.0 Psig Δ**

**Analog Inputs**

Motor Current	I/O	A/D bit Value	Calibrated Value
Remote Capacity %		2135	153.0 Psig

**Device Calibration**

Default Devices

0-414.5 psia (4-20ma)

Custom Device

Min: 29.9 "Hg  
Max: 400.0 Psig

**Channel Calibration**

Offset Adjustment: 0.0

Range: I/O jumpers selection: 4ma - 20ma

Min: 4.0 ma  
Max: 20.0 ma

Page: 1 2 **3** 4 5 6 | Menu

Maintenance | User Access | Log off | Help

No Scheduled Maintenance | User: admin | 07/15/2015 11:46:06 | Run Hours: 0

No Alarm/Trips Present | Run Hours: 0

**Capacity Slide**: 0.1% | Stop | Remote Lock Out

**Volume Slide**: 0.0% | Alarm Reset | Unit Start

**Process Press Control**: Setpoint 30.0 Psig

**Suction**: Press 42.9 Psig, Temp 25.5 °F

**Discharge**: Press 177.0 Psig, Temp -5.1 °F

**Discharge : Suction**: Press Ratio 3.3

**Oil**: Press Diff 118.8 Psig, Filter Diff 5.8 Psig, Inj Temp 78.3 °F, Sep Temp 190.5 °F

**Motor**: Amperage 0.0 Amps

Figure 13-4. Instruments Calibration Screen - Process Pressure (Page 3)

**Suction Pressure 1** | **Stopped** | **6.2 Psig Δ**

**Analog Inputs**

Motor Current	I/O	A/D bit Value	Calibrated Value
Remote Capacity %		19	1.2 Amps

**4-20ma Scale**

4ma: 0 Amps | 20ma: 250.0 Amps

Enter Desired Value: [ ] | Total Error: 0 | Clear Error

**Current Transformer Ratio**

Primary: 250.0 Amps | Secondary: 5 Amps

Enter Desired Value: [ ] | Total Error: 0 | Clear Error

Page: 1 2 **3** 4 5 6 | Menu

Maintenance | User Access | Log off | Help

No Scheduled Maintenance | User: Vilter | 06/29/2017 03:01:59 | Run Hours: 0

No Alarm/Trips Present | Run Hours: 0

**Capacity Slide**: 0.6% | Stop | Remote Lock Out

**Volume Slide**: 0.0% | Alarm Reset | Unit Start

**Suction Press Control**: Setpoint 20.0 Psig

**Suction**: Press 26.2 Psig, Temp 42.9 °F

**Discharge**: Press 119.2 Psig, Temp 175.7 °F

**Discharge : Suction**: Press Ratio 3.3

**Oil**: Press Diff 138.6 Psig, Filter Diff 9.8 Psig, Inj Temp 112.6 °F, Sep Temp 110.1 °F

**Motor**: Amperage 1.2 Amps

Figure 13-5. Instruments Calibration Screen - Motor Current (Page 3)

## Section 13 • Instruments Calibration

### Remote Capacity

The remote capacity input allows a system controller (such as a PLC) to control the capacity position during direct I/O control.

Control Input:

- This dropdown box is not used at this time.

Scale:

- Defines the minimum and maximum Capacity position between 0% & 100% for the 4-20ma input.

Offset:

- Used to correct any error in the capacity position. By entering a value into the Adjustment entry box, that value will be added to the total offset displayed in the “total offset” entry box.

### Analog Inputs

This section of the Calibration screen allows the operator to define the parameters of an installed auxiliary analog instrument. These instruments are usually not part of a typical compressor set-up but Vission 20/20 provides a way for the operator to add additional capabilities. The layout of this screen is typical to the pressure and temperature calibration screens. For Analog Inputs screens, see Figures 13-6 and 13-7.

Device Calibration:

- These setpoints allow the operator to define what the input from the auxiliary instrument means in terms of units and range. If a temperature measuring instrument is connected, then the operator would select temperature from the Unit drop-down box then set the maximum and minimum value for the scale.

The screenshot shows the 'Analog Inputs' calibration screen. At the top, it indicates 'Suction Pressure 1' is 'Stopped' at '6.6 Psig Δ'. The main area is divided into 'Device Calibration' and 'Channel Calibration' sections. The 'Device Calibration' section includes a 'Units' dropdown set to 'Temperature', and 'Min' and 'Max' input fields both set to '0.0 °F'. The 'Channel Calibration' section includes an 'Offset' section with an 'Adjustment' field and a 'Total Offset' field both set to '0.0', and a 'Range' section with an 'I/O jumpers selection' dropdown set to '4ma - 20ma', and 'Min' and 'Max' input fields set to '4.0 ma' and '20.0 ma' respectively. On the right side, there are 'Capacity Slide' and 'Volume Slide' controls, both set to '0.0 %', and a 'Unit Start' button. Below these are 'Suction Press Control' and 'Discharge' status indicators. The bottom of the screen features a navigation bar with 'Page' buttons (1-6), a 'Menu' button, and a status bar with 'Maintenance', 'User Access', 'Log off', and 'Help' buttons. The status bar also displays 'No Scheduled Maintenance', 'No Alarm/Trips Present', 'User: admin', '11/07/2014 14:08:26', 'Run Hours: 0', and 'Panel 1'. On the far right, a vertical panel shows 'Suction Press Control' with a 'Setpoint' of '20.0 Psig', 'Suction' with 'Press' at '26.6 Psig' and 'Temp' at '55.0 °F', 'Discharge' with 'Press' at '124.2 Psig' and 'Temp' at '71.5 °F', 'Discharge : Suction' with 'Press Ratio' at '3.4', 'Oil' with 'Press Diff' at '46.2 Psig', 'Filter Diff' at '9.5 Psig', 'Inj Temp' at '115.3 °F', and 'Sep Temp' at '110.3 °F', and 'Motor' with 'Amperage' at '0.0 Amps'.

Figure 13-6. Instruments Calibration Screen - Analog Inputs (Page 4)

## Section 13 • Instruments Calibration

Offset:

- Once the two-point calibration is completed, it is not uncommon for a small error to exist. By entering the value of the error from the calibrated value and the actual value into the adjustment entry box, that error will be added/subtracted from the total offset. The offset is applied to the calibrated value which should correct the error.

Range:

- Here the operator defines the signal type and range transmitted by the instrument. The operator can choose from several predefined ranges in the drop-down box or enter a value.

The screenshot shows the 'Analog Inputs' calibration screen. At the top, it indicates 'Suction Pressure 1' is 'Stopped' at '6.6 Psig Δ'. The main area is divided into several sections:

- Analog Inputs List:** A list of inputs from Aux 9 to Aux 16.
- I/O Section:** Shows 'A/D bit Value' as 0 and 'Calibrated Value' as 0.0 °F.
- Device Calibration:** Includes a 'Units' dropdown set to 'Temperature' and 'Min' and 'Max' values both set to 0.0 °F.
- Channel Calibration:** Includes 'Offset' (0.0), 'Adjustment' (empty), 'Total Offset' (0.0), 'Range' (4.0 ma to 20.0 ma), and 'I/O jumpers selection' (4ma - 20ma).

On the right sidebar, there are control buttons: 'Stop' (red), 'Remote Lock Out' (yellow), 'Alarm Reset' (yellow), and 'Unit Start' (green). Below these are status indicators for 'Capacity Slide' (0.0%) and 'Volume Slide' (0.0%).

The bottom section of the screen displays system information:

- Suction Press Control:** Setpoint 20.0 Psig.
- Suction:** Press 26.6 Psig, Temp 55.2 °F.
- Discharge:** Press 124.0 Psig, Temp 71.5 °F.
- Discharge : Suction:** Press Ratio 3.4.
- Oil:** Press Diff 46.2 Psig, Filter Diff 9.8 Psig, Inj Temp 115.6 °F, Sep Temp 110.5 °F.
- Motor:** Amperage 0.0 Amps.

At the very bottom, there are buttons for 'Maintenance', 'User Access', 'Log off', and 'Help'. The status shows 'No Scheduled Maintenance' and 'No Alarm/Trips Present'. User information includes 'User: admin', '11/07/2014 14:09:24', and 'Run Hours: 0'.

Figure 13-7. Instruments Calibration Screen - Analog Inputs (Page 5)



## Section 13 • Instruments Calibration

### Analog Outputs

The Analog output card of the Vission 20/20 generates a 4–20mA signal to any attached devices. However, it is not uncommon that a small difference in the board components might result in a small difference in the output. So this screen offers the operator the ability to fine tune the upper and lower output values, see Figure 13-8.

Test Limits:

- By pressing either the Test Min or Test Max buttons, the output will go to either 4mA or 20 mA. The operator can then measure the output for accuracy.

Min (mA):

- If the 4mA output has an unacceptable amount of error, the operator can use the “+” & “-” buttons to adjust the output.

Max (mA):

- If the 20mA output has an unacceptable amount of error, the operator can use the “+” & “-” buttons to adjust the output

Offset (mA):

- By entering the value of the error from the calibrated value and the actual value into the offset entry box, that error will be added/subtracted from the mA value. The offset is applied to the mA value which should correct the error. Resolution of error should not be less than 0.01.

Apply Changes:

- Min (mA) and Max (mA) values are stored to database on by pressing this button. The offset (mA) value which is used to correct 4mA or 20mA output is hence not saved until this button is pressed.

**Suction Pressure 1**      **Stopped**      **6.6 Psig Δ**

**Capacity Slide**      **Stop**  
0.0 %

**Volume Slide**      **Remote Lock Out**  
0.0 %

**Alarm Reset**  
**Unit Start**

**Suction Press Control**  
**Setpoint 20.0 Psig**

**Suction**  
**Press 26.6 Psig**  
**Temp 55.2 °F**

**Discharge**  
**Press 124.3 Psig**  
**Temp 71.2 °F**

**Discharge : Suction**  
**Press Ratio 3.4**

**Oil**  
**Press Diff 45.9 Psig**  
**Filter Diff 9.5 Psig**  
**Inj Temp 115.3 °F**  
**Sep Temp 110.1 °F**

**Motor**  
**Amperage 0.0 Amps**

**Analog Outputs**

	Test Limits		Min (mA)	Offset (mA)	Max (mA)	Offset (mA)
Compressor VFD	Test Min	Test Max	4.0		20.0	
Condenser VFD	Test Min	Test Max	4.0		20.0	
% Slide Valve Pos.	Test Min	Test Max	4.0		20.0	
Liquid Inj. Motorized Valve	Test Min	Test Max	4.0		20.0	
Aux 1 : Analog Aux out 1	Test Min	Test Max	4.0		20.0	
Aux 2 : Analog Aux out 2	Test Min	Test Max	4.0		20.0	
Aux 3 : Analog Aux out 3	Test Min	Test Max	4.0		20.0	
Aux 4 : Analog Aux out 4	Test Min	Test Max	4.0		20.0	

Apply Changes

Page 1 2 3 4 5 6 Menu

Maintenance User Access Log off Help Panel 1

**No Scheduled Maintenance**      User admin  
11/07/2014 14:10:56

**No Alarm/Trips Present**      Run Hours 0

Figure 13-8. Instruments Calibration Screen - Analog Outputs (Page 6)



## Section 14 • Slide Calibration

### Overview

The Slide Calibration screen is used for calibration of the slide actuators and to establish Vission 20/20 control parameters. It is important that the operator uses caution while operating in this screen, see Figure 14-1. The normal safety checks that prevent the slide from colliding with the mechanical stops are overridden. When the calibration process is completed and the operator exits the screen, both actuators will return the slides back to their minimum positions.

### Capacity Slide Valve Potentiometer

This section provides critical information and control parameters related to the capacity slide actuator. The “% cap” display shows the actual value in percent of the capacity slide without any conditioning that might be applied to the other capacity position displays. In addition,

this section displays the value of the actuator’s signal in millivolts in the “input Value” display box.

“-” Button:

- When the operator presses and holds this button, the output associated with capacity slide decrease is energized. If the actuator does not turn in the correct direction when this button is pressed, then the operator will have to alter how the actuator is wired to the panel.

“+” Button:

- When the operator presses and holds this button, the output associated with capacity slide increase is energized. If the actuator does not turn in the correct direction when this button is pressed, then the operator will have to alter how the actuator is wired to the panel.

Software limit setpoint:

- The Vission 20/20 uses the “Min Limit” and “Max Limit” setpoints to define an area within the

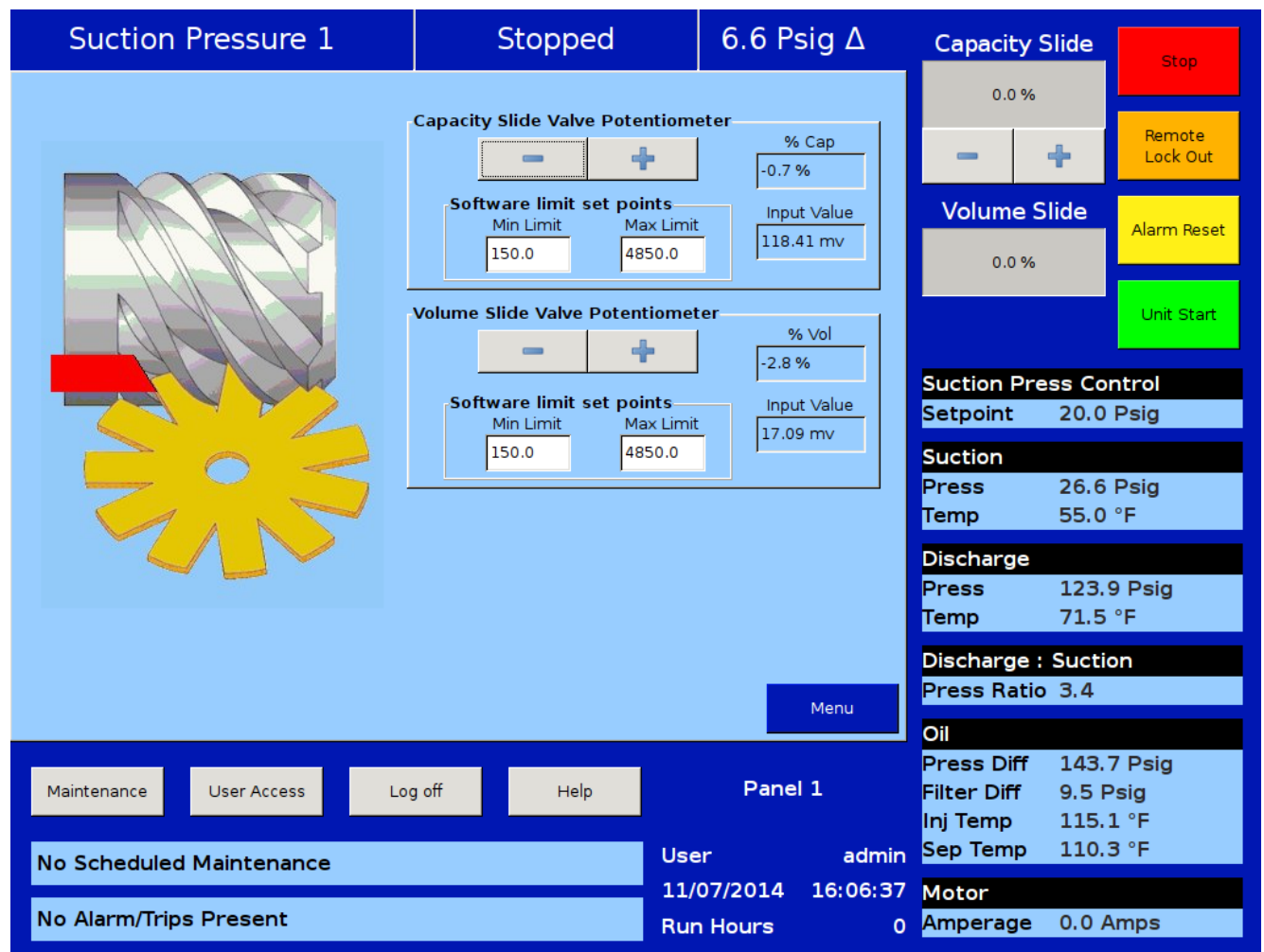

Figure 14-1. Slide Calibration Screen

## Section 14 • Slide Calibration

---

mechanical stops for normal slide travel. These software limits' purpose is to prevent the slide from actually hitting the mechanical stops which could result in a number of undesirable consequences. By default, the software limits are set to 150mV from either end point. The position percentage is calculated from the software limits. Therefore, it is possible to read a value greater than 100% or less than 0% if inertia carries the slides after these limits are reached.

### Volume Slide Valve Potentiometer

This section provides critical information and control parameters related to the volume slide actuator. The "% Vol" display shows the actual value in percent of the volume slide without any conditioning that might be applied to the other volume position displays. In addition, this section displays the value of the actuator's signal in millivolts in the "input Value" display box.

"-" Button:

- When the operator presses and holds this button, the output associated with volume slide decreases is energized. If the actuator does not turn in the correct direction when this button is pressed, then the operator will have to alter how the actuator is wired to the panel.

"+" Button:

- When the operator presses and holds this button, the output associated with volume slide increase is energized. If the actuator does not turn in the correct direction when this button is pressed, then the operator will have to alter how the actuator is wired to the panel.

Software limit setpoint:

- The Vission 20/20 uses the "Min Limit" and "Max Limit" setpoints to define an area within the mechanical stops for normal slide travel. These software limits' purpose is to prevent the slide from actually hitting the mechanical stops which could result in a number of undesirable consequences. By default, the software limits are set to 150mV from either end point. The position percentage is calculated from the software limits. Therefore It is possible to read a value greater than 100% or less than 0% if inertia carries the slides after these limits are reached.

### Slide Valve Operation

The slide valve actuator is a gear-motor with a position sensor. The motor is powered in the forward and reverse directions from the main computer in the control panel. The position sensor tells the main computer the position of the slide valve. The main computer uses the position and process information to decide where to move the slide valve next.

During calibration, the position sensor records the high and low count of motor turns. The operator tells the position sensor when the actuator is at the high or low position with the push button. Refer to the calibration instructions for the detailed calibration procedure.

The position sensor can get "lost" if the motor is moved while the position sensor is not powered. To prevent this, the motor can only be moved electrically while the position sensor is powered. When the position sensor loses power, power is cut to the motor. A capacitor stores enough energy to keep the position sensor circuitry alive long enough for the motor to come to a complete stop and then save the motor position to non-volatile EEPROM memory. When power is restored, the saved motor position is read from EEPROM memory and the actuators resumes normal function.

This scheme is not foolproof. If the motor is moved manually while the power is off or the motor brake has failed, allowing the motor to freewheel for too long after the position sensor loses power, the actuator will lose its calibrated position.

A brake failure can sometimes be detected by the position sensor. If the motor never stops turning after a power loss, the position sensor detects this, knows it will be lost, and goes immediately into calibrate mode when power is restored.

## Section 14 • Slide Calibration

### Calibrate Slide Valve Actuators

Assuming that the actuator's motors have not been calibrated, the transmitter output of the actuator motor will fluctuate wildly until they are calibrated. To prevent damage to actuator's motors, do not connect the Power Cable (Yellow TURCK cable) or the Position Transmitter Cable (Gray TURCK cable) until instructed to do so in this procedure.

1. Open the plastic cover of the capacity motor by removing four screws. Gently lift the cover and tilt it toward the TURCK connectors. Raise the cover enough to be able to press the blue calibrate button and to be able to see the red LED on the top of the assembly, see Figure 14-2.
2. Log into the Vission 20/20.
3. From the main screen select the Menu button, and then the Slide Calibration button, see Figure 14-3.
4. When the "Slide Calibration" screen appears, then you can safely connect the Power Cable (Yellow TURCK cable) and the Position Transmitter Cable (Gray TURCK cable) to the Capacity motor.
5. Press "+" or "-" to move the slide valves to check the rotation, see Table 14-1 for proper shaft rotation. If for any reason the "+" or "-" command on the panel does not correspond to the slide increase or decrease, swap the blue & brown wires of the Yellow TURCK cable in the control panel to reverse the rotation of the motor.

### CAUTION

**DO NOT CONTINUE TO ENERGIZE THE ACTUATOR MOTOR AFTER THE SLIDE HAS REACHED THE MECHANICAL STOP. Doing so may cause mechanical damage to the motor or shear the motor shaft key. When the slide has reached the mechanical stop position, press the button in the center of the photo-chopper to release the brake, and thereby release the tension on the actuator motor.**

6. Quickly press and release the BLUE CALIBRATION BUTTON on the ACTUATOR motor once, see Figure 14-4. This instructs the ACTUATOR motor to enter the calibration mode. The red LED on the actuator control board will begin flashing. Use the "-" button on the Vission 20/20 panel to drive the capacity slide to its minimum mechanical stop position. This will be apparent by a slowing of the motor rotation and a winding sound from the actuator motor. When you hear the motor wind-up, release the "-" button.

Then use the "+" button to pulse the motor so that the capacity slide is "just off" of its minimum position and there is no tension on the motor shaft.

7. Quickly press and release the BLUE CALIBRATION BUTTON on the ACTUATOR motor once. The red LED will now flash at a slower rate. This now instructs the ACTUATOR motor that this point is the minimum slide position. This point will correspond to 0 volts AFTER the ACTUATOR calibration procedure is completed.

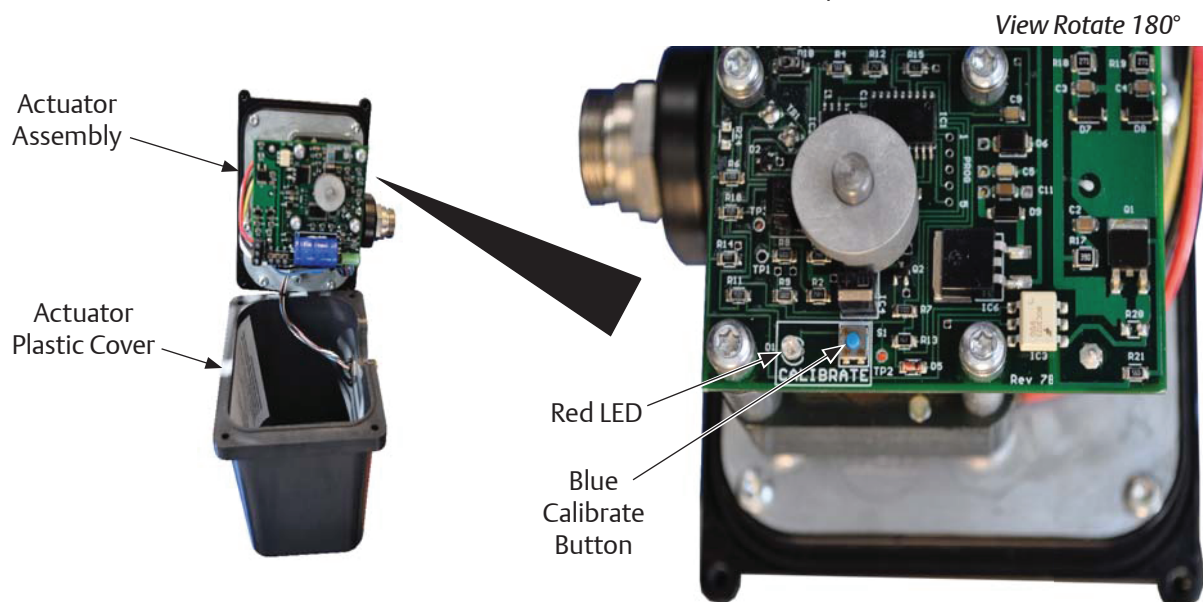

Figure 14-2. Actuator Assembly

# Section 14 • Slide Calibration

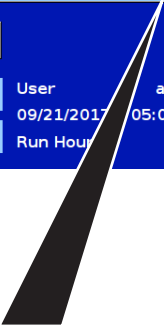

Figure 14-3. Menu Screen and Slide Calibration Button (Vision 20/20)

## Section 14 • Slide Calibration

8. Use the “+” button on the Vission 20/20 to drive the capacity slide to its maximum mechanical stop position. This will be apparent by a slowing of the motor rotation and a winding sound from the actuator motor. When you hear the motor wind-up, release the “+” button.
9. Quickly press and release the BLUE CALIBRATION BUTTON on the ACTUATOR motor once. The RED LED will stop flashing. This now instructs the ACTUATOR motor that this point is the maximum slide position. This point corresponds to 5 volts. The ACTUATOR calibration procedure is completed.  
  
Now the Capacity Channel is automatically calibrated based on the calibration settings made to the actuator.
10. Gently lower the plastic cover to where it contacts the base and O-ring seal. After making sure that the cover is not binding, gently tighten the four screws.
11. Repeat the same procedure for the Volume slide motor.

### CAUTION

**Do not over tighten screws. Failure to comply may result in damage to equipment.**

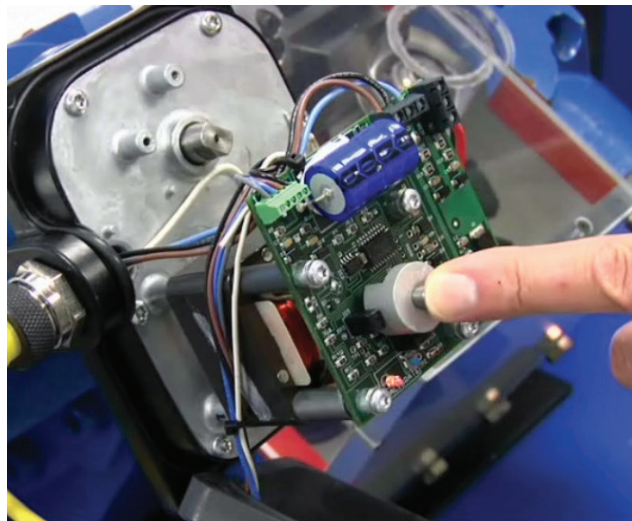

**Figure 14-4. Photo-chopper**

*Press down on Photo-chopper to release tension from motor mount.*



## Section 14 • Slide Calibration

### Command Shaft Rotation

The following table describes the rotation direction required by the actuator. Every optical actuator has the ability to be wired to rotate in either direction. Energizing the blue actuator wire results in a CCW rotation and energizing the brown wire results in a CW rotation, see Table 14-1. Command Shaft Rotation Required By Actuator.

**Table 14-1. Command Shaft Rotation Required By Actuator**

Compressor Model	Command Shaft Rotation				Number of Turns / Rotation Angle / Slide Travel					
	Capacity		Volume		Capacity			Volume		
	INC	DEC	INC	DEC	Turns	Angle	Travel	Turns	Angle	Travel
VSR 111	CW	CCW	CW	CCW	0.91	328	3.568"	0.52	187	2.045"
VSR 151	CW	CCW	CW	CCW	0.91	328	3.568"	0.52	187	2.045"
VSR 221	CW	CCW	CW	CCW	0.91	328	3.568"	0.52	187	2.045"
VSR 301	CW	CCW	CW	CCW	0.91	328	3.568"	0.52	187	2.045"
VSS 451	CW	CCW	CW	CCW	0.91	328	3.568"	0.52	187	2.045"
VSS 601	CW	CCW	CW	CCW	0.91	328	3.568"	0.52	187	2.045"
VSS 751	CCW	CW	CCW	CW	1.09	392	4.283"	0.63	227	2.473"
VSS 901	CCW	CW	CCW	CW	1.09	392	4.283"	0.63	227	2.473"
VSS 1051	CCW	CW	CCW	CW	1.22	439	4.777"	0.74	266	2.889"
VSS 1201	CCW	CW	CCW	CW	1.22	439	4.777"	0.74	266	2.889"
VSS 1301	CCW	CW	CCW	CW	1.22	439	4.777"	0.74	266	2.889"
VSS 1501	CCW	CW	CCW	CW	1.36	490	5.325"	0.82	295	3.200"
VSS 1551	CCW	CW	CCW	CW	1.48	533	5.823"	0.87	313	3.433"
VSS 1801	CCW	CW	CCW	CW	1.36	490	5.325"	0.82	295	3.200"
VSS 1851	CCW	CW	CCW	CW	1.48	533	5.823"	0.87	313	3.433"
VSS 2101	CCW	CW	CCW	CW	1.48	533	5.823"	0.87	313	3.433"
VSS 2401	CCW	CW	CCW	CW	1.80	648	7.072"	1.36	490	5.341"
VSS 2601	CCW	CW	CCW	CW	1.80	648	7.072"	1.36	490	5.341"
VSS 2801	CCW	CW	CCW	CW	1.80	648	7.072"	1.36	490	5.341"
VSS 3001	CCW	CW	CCW	CW	1.80	648	7.072"	1.36	490	5.341"
VSM 71	CW	CCW	CW	CCW	0.80	288	3.141"	0.45	162	1.767"
VSM 91	CW	CCW	CW	CCW	0.80	288	3.141"	0.45	162	1.767"
VSM 101	CW	CCW	CW	CCW	0.80	288	3.141"	0.45	162	1.767"
VSM 151	CW	CCW	CW	CCW	0.80	288	3.141"	0.45	162	1.767"
VSM 181	CW	CCW	CW	CCW	0.80	288	3.141"	0.45	162	1.767"
VSM 201	CW	CCW	CW	CCW	0.80	288	3.141"	0.45	162	1.767"
VSM 301	CW	CCW	CW	CCW	0.80	288	3.141"	0.45	162	1.767"
VSM 361	CW	CCW	CW	CCW	0.80	288	3.141"	0.45	162	1.767"
VSM 401	CW	CCW	CW	CCW	0.80	288	3.141"	0.45	162	1.767"
VSM 501	CCW	CW	CCW	CW	0.91	328	3.568"	0.52	187	2.045"
VSM 601	CCW	CW	CCW	CW	0.91	328	3.568"	0.52	187	2.045"
VSM 701	CCW	CW	CCW	CW	0.91	328	3.568"	0.52	187	2.045"

## Section 14 • Slide Calibration

### Slide Valve Troubleshooting Guide

The Analog output card of the Vission 20/20 produces a 4–20mA signal to any attached devices. However, it is not uncommon that small differences in the board components might result in small differences in the output. So this screen offers the operator the ability to fine tune the upper and lower output values, see Table 14-2, Slide Valve Troubleshooting Guide.

**Table 14-2. Slide Valve Troubleshooting Guide (1 of 3)**

Problem	Reason	Solution
The actuator cannot be calibrated.	Dirt or debris is blocking one or both optocoupler slots.	Clean the optocoupler slots with a cotton swab and rubbing alcohol.
	The photo-chopper fence extends less than about half way into the optocoupler slots.	Adjust the photo-chopper so that the fence extends further into the optocoupler slots. Make sure the motor brake operates freely and the photo-chopper will not contact the optocouplers when the shaft is pressed down.
	The white calibrate wire in the grey Turck cable is grounded.	Tape the end of the white wire in the panel and make sure that it cannot touch metal.
	Dirt and/or condensation on the position sensor boards are causing it to malfunction.	Clean the boards with an electronics cleaner or compressed air.
	The calibrate button is stuck down.	Try to free the stuck button.
	The position sensor has failed.	Replace the actuator.
	Push button is being held down for more that ¼ second when going through the calibration procedure.	Depress the button quickly and then let go. Each ¼ second the button is held down counts as another press.

## Section 14 • Slide Calibration

Table 14-2. Slide Valve Troubleshooting Guide (2 of 3)

Problem	Reason	Solution
The actuator goes into calibration mode spontaneously.	The white calibrate wire in the grey Turck cable is grounding intermittently.	Tape the end of the white wire in the panel and make sure that it cannot touch metal.
	A very strong source of electromagnetic interference (EMI), such as a contactor, is in the vicinity of the actuator or grey cable.	Increase the distance between the EMI source and the actuator. Install additional metal shielding material between the EMI source and the actuator or cable.
	There is an intermittent failure of the position sensor	Replace the actuator.
The actuator goes into calibration mode every time power is restored after a power loss	The motor brake is not working properly.	Get the motor brake to where it operates freely and recalibrate.
	The position sensor's EEPROM memory has failed	Replace the actuator.
The actuator does not transmit the correct position after a power loss.	The motor was manually moved while the position sensor was not powered.	Recalibrate.
	The motor brake is not working properly.	Get the motor brake to where it operates freely and recalibrate.
	The position sensor's EEPROM memory has failed	Replace the actuator.
There is a rapid clicking noise when the motor is operating.	The photo-chopper is misaligned with the slotted optocouplers.	Try to realign or replace the actuator.
	The photo-chopper is positioned too low on the motor shaft.	Adjust the photo-chopper so that the fence extends further into the optocoupler slots.
	A motor bearing has failed	Replace the actuator.
The motor operates in one direction only	There is a loose connection in the screw terminal blocks.	Tighten
	There is a loose or dirty connection in the yellow Turck cable.	Clean an tighten
	The position sensor has failed.	Replace the actuator.
	There is a broken motor lead or winding	Replace the actuator.



## Section 14 • Slide Calibration

Table 14-2. Slide Valve Troubleshooting Guide (3 of 3)

Problem	Reason	Solution
The motor will not move in either direction	The thermal switch has tripped because the motor is overheated	The motor will resume operation when it cools. This could be caused by a malfunctioning control panel. Consult the factory.
	Any of the reasons listed in “The motor operates in one direction only”	See above.
	The command shaft is jammed.	Free the command shaft.
	Broken gears in the gear-motor.	Replace the actuator.
	Blown relays or fuses.	Check and replace blown relays and/or fuse
The motor operates intermittently, several minutes on, several minutes off.	Motor is overheating and the thermal switch is tripping.	This could be caused by a malfunctioning control panel. Consult the factory.
The motor runs sporadically	Bad thermal switch.	Replace the actuator.
	Any of the reasons listed in “The motor operates in one direction only”	See above.
The motor runs but output shaft will not turn.	Stripped gears inside the gear rotor, or the armature has come unpressed from the armature shaft.	Replace the actuator.

# Section 14 • Slide Calibration

## Slide Valve Actuator Troubleshooting Guide Blink Code

Vilter™ actuators communicate problems discovered by the internal diagnostics to the technician by LED blink codes. Only one blink code is displayed, even though it is possible that more than one problem has been detected. The actuator motor will not operate until the error code is cleared by pressing the blue bottom, see Table 14-3. LED Blink Codes and Troubleshooting Guide.

**Table 14-3. LED Blink Codes and Troubleshooting Guide (1 of 2)**

Flash Pattern * = ON - = OFF	Meaning
*_*_*_*_*_*_*_*_*_*_*_*_*_*	Calibration step 1.
*_*_*_*_*_*_*_*_*_*_*_*_*_*	Calibration step 2.
*_*-----	<p>This indicates a zero span. This error can only occur during calibration. The typical cause is forgetting to move the actuator when setting the upper limit of the span. If this is the case, press the blue button to restart the calibration procedure. This error can also occur if either or both of the slotted optocouplers are not working. If this is the case, the slide valve actuator will have to be replaced. The operation of the slotted optocouplers can be tested as follows:</p> <ol style="list-style-type: none"> <li>1. Manually rotate the motor shaft until the aluminum photo-chopper fence is not blocking either of the optocoupler slots.</li> <li>2. Using a digital multimeter, measure the DC voltage between terminal 3 of the small terminal block and TP1 on the circuit board (see Note 1). The measurement should be between 0.1 and 0.2 Volts.</li> <li>3. Next, measure the DC voltage between terminal 3 and TP2 on the circuit board. You should measure between 0.1 and 0.2 Volts.</li> </ol>
*-----	<p>This error means that the slide valve actuator is no longer transmitting accurate position information. The actuator should be recalibrated as soon as possible, after the cause of the over-speed is identified and corrected. This error will not clear until the actuator is re-calibrated.</p> <p>This code can be caused by:</p> <ol style="list-style-type: none"> <li>1. The motor speed exceeding the position sensors ability to measure it at some time during operation. A non-functioning motor brake is usually to blame.</li> <li>2. The actuator is being operated where strong infrared light can falsely trigger the slotted optocouplers, such as direct sunlight. Shade the actuator when the cover is off for service and calibration. Do not operate the actuator with the cover off.</li> </ol>

## Section 14 • Slide Calibration

Table 14-3. LED Blink Codes and Troubleshooting Guide (2 of 2)

Flash Pattern * = ON - = OFF	Meaning
*_*_*-----	<p>The motor is overheated. The actuator motor will not run until it cools. Once the motor cools, the actuator will resume normal operation.</p> <p>Motor overheating is sometimes a problem in hot humid environments when process conditions demand that the slide valve actuators reposition often. Solutions are available; consult your Vilter™ authorized distributor for details.</p> <p>Another possible cause for this error is a stuck motor thermal switch. The thermal switch can be tested by measuring the DC voltage with a digital multimeter between the two TS1 wire pads (see Note 2). If the switch is closed (normal operation) you will measure 0 Volts.</p>
*****	<p>The 24V supply voltage is low. This will occur momentarily when the actuator is powered up and on power down. If the problem persists, measure the voltage using a digital multimeter between terminals 3 and 4 of the small terminal block. If the voltage is less than 24V, the problem is in the supply to the board. If the voltage is <math>\geq</math> 24V, replace the actuator.</p>
_*****	<p>The EEPROM data is bad. This is usually caused by loss of 24V power before the calibration procedure was completed. The actuator will not move while this error code is being displayed. To clear the error, calibrate the actuator. If this error has occurred and the cause was not loss of 24V power during calibration, possible causes are:</p> <ol style="list-style-type: none"> <li>1. The EEPROM memory in the micro-controller is bad.</li> <li>2. The large blue capacitor is bad or has a cracked lead.</li> </ol>
****_*-----	<p>Micro-controller program failure. Please notify your Vilter™ authorized distributor.</p>

\* There are two versions of slide valve actuators, version A and B. Only version B is able to display LED blink codes. Slide valve actuator version B can be distinguished by only having a single circuit board as supposed to two circuit boards in version A.

Note 1: TP1 and TP2 are plated-thru holes located close to the slotted optocouplers on the board. They are clearly marked on the board silkscreen legend.

Note 2: The TS1 wire pads are where the motor thermal switch leads solder into the circuit board. They are clearly marked on the board's silkscreen legend and are oriented at a 45 degree angle.

## Section 15 • Trend Chart

### Overview

This screen allows the operator to view and adjust settings for the trend chart, see Figure 15-1. The trending feature can be started & stopped from this screen. Up to four variables can be selected for plotting on screen. Each variable is assigned one of four colors; the plotted trace and the vertical axis labels for a variable will be in its assigned color. The operator can select from viewing the plot to which variables and time intervals to show as often as necessary. The vertical axis scaling and offset for each variable plotted is based on its range of values over the entire data plotted on screen. The data available for display is 120 hours maximum.

### Chart Operation

Pen Selection:

- Pen selection allows the operator to select up to four different variables to plot on the screen (In red, blue, green or orange). The operator can select “None” as an option to disable the plotting of data for a particular pen. The options in the pen selection drop-down boxes will depend on the channels selected in the Trend Setup screen.

Start/Stop:

- This button allows the operator to start/stop the trend feature. When the trend feature is not running, the button will display “Start” and will be green in color. While the trend feature runs, the button will display “Stop” and will be red in color. When the “Stop” button is pressed, the trend data is saved to a file.



Figure 15-1. Trend Chart Screen

## Section 15 • Trend Chart

---

### Zoom In/Out:

- These buttons allow the operator to adjust the number of data points plotted on the screen. At maximum zoom level the operator can view 3 minutes of trend data and the Zoom In button will be inactive. At minimum zoom level the operator can view full 120 hours of trend data and the Zoom Out button will be inactive.

### Back/Forward:

- These buttons allow the operator to move the plot and view trend data at different time intervals.
- The forward button will be inactive when the operator is viewing the first data point plotted on the screen (i.e. when the displayed time interval is 0:00). The back button will be inactive when the operator is viewing the last data point on the screen (i.e. when the displayed time interval is 20:00). At minimum zoom level, both Back & Forward buttons will be inactive.

### Trace:

- This button allows the operator to move a white cursor line across all four trend lines and receive a read-out of all four variables at that point in time. When the Trace button is pressed, the cursor position is displayed along with value of all four variables on the screen.

### Hold:

- This button allows the operator to stop the data from advancing on the display without stopping the trend feature. When the Hold button is pressed, the Hold Time is displayed on the screen.

### Trace Back( < ) / Forward ( > ):

- These buttons allow the operator to move a white cursor line across trend lines and to view trend data values at that point. These buttons will only be active when the trace button is pressed. When these buttons are pressed, the cursor is moved and the trace position is updated on the screen.

### Setup:

- This button allows the operator to open the Trend Setup screen. This button is inactive when the trend feature is running.

## Trend Data Storage

The trend analysis screen shows recorded data for problem analysis or tuning improvements. A logging buffer holds 5 minutes of data sampled at 10 second intervals.

When the logging buffer fills with 5 minutes of data, it is automatically transferred to a temp .csv file. A temp trend file will hold up to 1MB of accumulated data. When the temp file has accumulated 1MB of data, the data from the temp file is written to new trend file and the temp file is overwritten with new data in the logging buffer till next 1MB of data. When a total of 15MB of trend data is accumulated, and the logging buffer has filled with another 5 minutes of data to write, the file with the oldest trend data is deleted.

Note: Trend data will be stored with either temperature or pressure units depending on the selected Process Control Mode.

## Section 15 • Trend Chart

### Setup

The operator can modify trending options through the Trend Setup screen, see Figure 15-2.

Trend Setup screen can be accessed by pressing the Setup button when the trending feature is not running. Trend Setup screen allows the operator to select a maximum of 10 analog I/O channels for trending. The operator can also set a path for the trend data files from the drop-down box in the setup screen. A USB drive will appear as an option in the drop-down box only when it's already mounted on the panel.

If there is no space available on the USB, the trend data files will be written to hard disk.

If the operator changes Press/Temp units or switches Process Control Modes from the configuration screen when running the trending feature, then the background trending will stop.

The screenshot displays the Trend Setup screen with the following components:

- Header:** Suction Pressure 1, Stopped, 23.7 Psig Δ
- Trend Setup Panel:**
  - Checked Items:** Motor Current, Suction Press, Discharge Press, Oil Filter Press, Oil Manifold Press, Suction Temp, Discharge Temp, Oil Separator Temp, Oil Manifold Temp, Process Control.
  - Unchecked Items:** Condenser Press, Remote Capacity %, Economizer Press, Capacity Slide, Volume Slide, Chiller Temp, Auxiliary Input #1-12, Auxiliary Input #13-16, Compressor VFD, Condenser VFD, Slide Valve Position, Liquid Injection, Auxiliary Output #1-4, Suction Superheat Temp.
  - Trend Files Location:** Hard Disk (selected)
  - Buttons:** OK
- Control Sliders:**
  - Capacity Slide:** 0.1% (with Stop, Remote Lock Out, and Alarm Reset buttons)
  - Volume Slide:** 0.0% (with Unit Start button)
- Process Control Data:**
  - Suction Press Control:** Setpoint 20.0 Psig
  - Suction:** Press 43.7 Psig, Temp 26.5 °F
  - Discharge:** Press 177.9 Psig, Temp -3.7 °F
  - Discharge : Suction:** Press Ratio 3.3
  - Oil:** Press Diff 118.9 Psig, Filter Diff 5.5 Psig, Inj Temp 78.6 °F, Sep Temp 191.4 °F
  - Motor:** Amperage 0.0 Amps
- Footer:**
  - Buttons: Maintenance, User Access, Log off, Help
  - Status: No Scheduled Maintenance, No Alarm/Trips Present
  - User: admin
  - Date/Time: 07/15/2015 11:34:19
  - Run Hours: 0

Figure 15-2. Trend Setup Screen

## Section 16 • Event List

### Overview

This screen is designed to display compressor events in chronological order. The information available on the screen is valuable to understand the operation of the compressor and troubleshooting, see Figure 16-1. This screen is divided into four columns and can list up to 128 separate events. The operator can download the information on the event list through the Data Backup Screen.

### Event list Columns

Date:

- Displays the date of the event in MM-DD-YYYY format.

Time:

- Displays the time of the event in HH:MM:SS format.

Event Type:

- Displays the type of message for a particular listing. Common types are “Start”, “Stop”, “Trip”, “Inhibit”, “Alarm”, “Info” and “System”. These help the operator to understand the meaning of the message in the next column.

Message:

- Displays the informational string that describes the event.

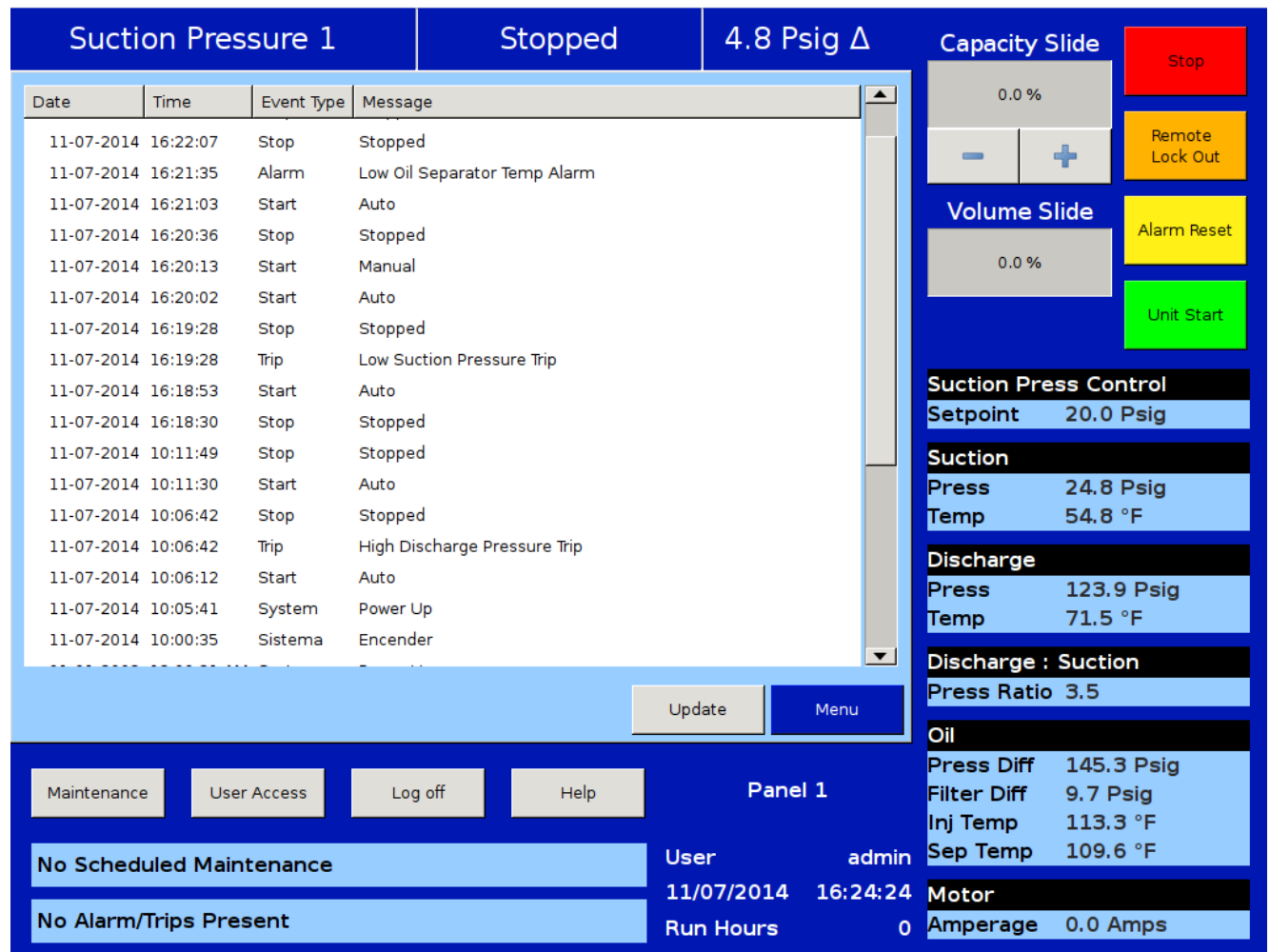

Figure 16-1. Event List Screen

## Section 17 • Input / Output

### Overview

This screen displays “Live Data” for all the analog points and digital points being monitored. There are four pages of Input / Outputs (I/O) available for viewing, see Figures 17-1, 17-2, 17-3, 17-4, 17-5 and 17-6. This screen also takes a snapshot of all the I/O points. If the compressor experiences a trip condition, it saves this data as Freeze pages, for example, see Figure 17-7. Up to five Freeze pages can be saved. The oldest Freeze page will be removed when more than five Freeze events occur. These Freeze events can be downloaded to a USB drive through the Data Backup screen, see Section 20.

Process Temperature or Process Pressure values will be displayed depending on Process Control Mode selection in Configuration Screen. Refer to Figures 17-1 and 17-2.

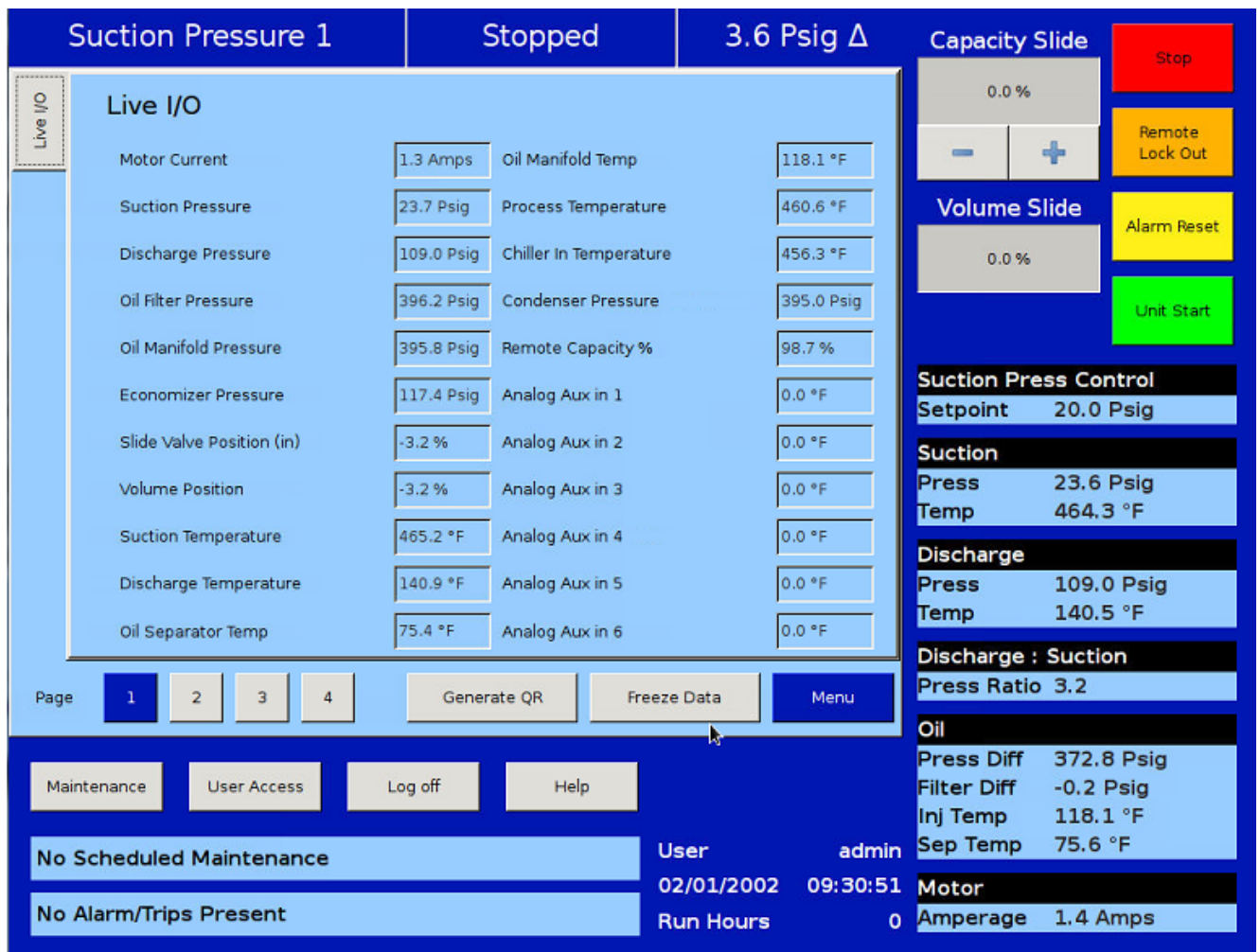

Figure 17-1. Input/Output Screen - Page 1



# Section 17 • Input / Output



Figure 17-2. Input/Output Screen - Page 1 (Process Pressure)

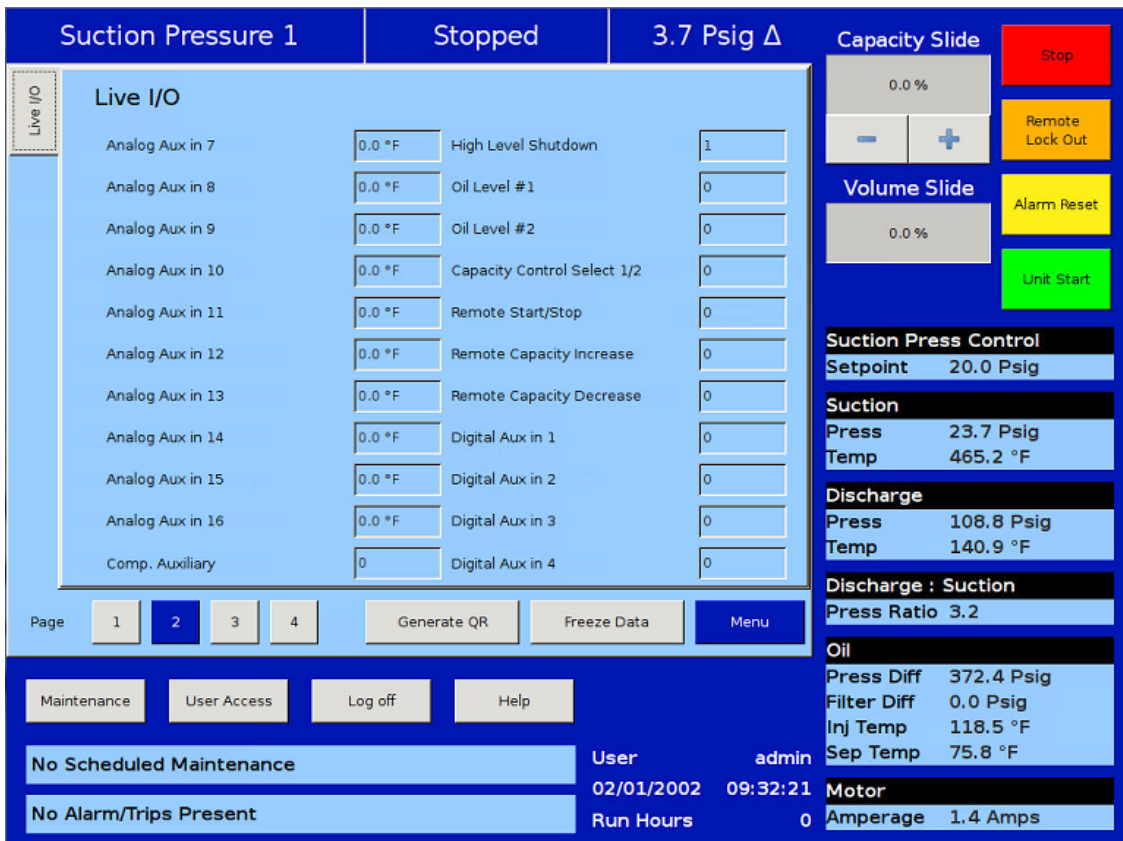

Figure 17-3. Input/Output Screen - Page 2

# Section 17 • Input / Output

**Suction Pressure 1**      **Stopped**      **3.7 Psig Δ**

**Live I/O**

Digital Aux in 5	0	Capacity Decrease	0
Digital Aux in 6	0	Volume Increase	0
Digital Aux in 7	0	Volume Decrease	0
Digital Aux in 8	0	Oil Separator Heater	1
Compressor VFD	4.0 mA	Trip	1
Condenser VFD	4.0 mA	Slide Valve Setpoint #1	0
Slide Valve Position (out)	4.0 mA	Slide Valve Setpoint #2	0
Liquid Injection	4.0 mA	Alarm	1
Compressor Start	0	Economizer Port #2	0
Oil Pump Start	0	Liquid Injection #1	0
Capacity Increase	0	Liquid Injection #2	0

Page: 1 2 3 4      Generate QR      Freeze Data      Menu

Maintenance      User Access      Log off      Help

No Scheduled Maintenance      User: admin  
02/01/2002 09:33:17  
No Alarm/Trips Present      Run Hours: 0

**Capacity Slide**  
0.0 %      Stop      Remote Lock Out

**Volume Slide**  
0.0 %      Alarm Reset      Unit Start

**Suction Press Control**  
Setpoint 20.0 Psig

**Suction**  
Press 23.7 Psig  
Temp 465.2 °F

**Discharge**  
Press 108.9 Psig  
Temp 140.9 °F

**Discharge : Suction**  
Press Ratio 3.2

**Oil**  
Press Diff 372.6 Psig  
Filter Diff 0.0 Psig  
Inj Temp 118.1 °F  
Sep Temp 75.8 °F

**Motor**  
Amperage 1.4 Amps

Figure 17-4. Input/Output Screen - Page 3

**Suction Pressure 1**      **Stopped**      **3.7 Psig Δ**

**Live I/O**

Remote Enabled	0	Analog Aux out 2	4.0 mA
Emergency Output	0	Analog Aux out 3	4.0 mA
Condenser Step #1	0	Analog Aux out 4	4.0 mA
Condenser Step #2	0		
Condenser Step #3	0		
Condenser Step #4	0		
Digital Aux out 1	0		
Digital Aux out 2	0		
Digital Aux out 3	0		
Digital Aux out 4	0		
Analog Aux out 1	4.0 mA		

Page: 1 2 3 4      Generate QR      Freeze Data      Menu

Maintenance      User Access      Log off      Help

No Scheduled Maintenance      User: admin  
02/01/2002 09:33:59  
No Alarm/Trips Present      Run Hours: 0

**Capacity Slide**  
0.0 %      Stop      Remote Lock Out

**Volume Slide**  
0.0 %      Alarm Reset      Unit Start

**Suction Press Control**  
Setpoint 20.0 Psig

**Suction**  
Press 23.7 Psig  
Temp 465.2 °F

**Discharge**  
Press 108.9 Psig  
Temp 140.7 °F

**Discharge : Suction**  
Press Ratio 3.2

**Oil**  
Press Diff 372.8 Psig  
Filter Diff -0.1 Psig  
Inj Temp 118.1 °F  
Sep Temp 75.6 °F

**Motor**  
Amperage 1.3 Amps

Figure 17-5. Input/Output Screen - Page 4

# Section 17 • Input / Output

**Suction Pressure 1**      **Stopped**      **3.7 Psig Δ**

**Capacity Slide**      **Stop**  
0.0 %      **Remote Lock Out**

**Volume Slide**      **Alarm Reset**  
0.0 %      **Unit Start**

**Freeze Data 02/01/2002 09:37:47 PM**

Remote Enabled	0	Analog Aux out 2	4.0 mA
Emergency Output	0	Analog Aux out 3	4.0 mA
Condenser Step #1	0	Analog Aux out 4	4.0 mA
Condenser Step #2	0		
Condenser Step #3	0		
Condenser Step #4	0		
Digital Aux out 1	0		
Digital Aux out 2	0		
Digital Aux out 3	0		
Digital Aux out 4	0		
Analog Aux out 1	4.0 mA		

**Suction Press Control**  
Setpoint 20.0 Psig

**Suction**  
Press 23.7 Psig  
Temp 465.2 °F

**Discharge**  
Press 108.9 Psig  
Temp 140.9 °F

**Discharge : Suction**  
Press Ratio 3.2

**Oil**  
Press Diff 372.6 Psig  
Filter Diff -0.2 Psig  
Inj Temp 118.3 °F  
Sep Temp 75.8 °F

**Motor**  
Amperage 1.5 Amps

Page 1 2 3 **4**      Generate QR      Menu

Maintenance      User Access      Log off      Help

No Scheduled Maintenance      User admin  
02/01/2002 09:40:57

No Alarm/Trips Present      Run Hours 0

Figure 17-6. Input/Output Screen - Page 4 (Remote Oil Cooler Enabled)

**Suction Pressure 1**      **Stopped**      **3.7 Psig Δ**

**Capacity Slide**      **Stop**  
0.0 %      **Remote Lock Out**

**Volume Slide**      **Alarm Reset**  
0.0 %      **Unit Start**

**Freeze Data 02/01/2002 09:37:47 PM**

Remote Enabled	0	Analog Aux out 2	4.0 mA
Emergency Output	0	Analog Aux out 3	4.0 mA
Condenser Step #1	0	Analog Aux out 4	4.0 mA
Condenser Step #2	0		
Condenser Step #3	0		
Condenser Step #4	0		
Digital Aux out 1	0		
Digital Aux out 2	0		
Digital Aux out 3	0		
Digital Aux out 4	0		
Analog Aux out 1	4.0 mA		

**Suction Press Control**  
Setpoint 20.0 Psig

**Suction**  
Press 23.7 Psig  
Temp 465.2 °F

**Discharge**  
Press 108.8 Psig  
Temp 140.9 °F

**Discharge : Suction**  
Press Ratio 3.2

**Oil**  
Press Diff 372.6 Psig  
Filter Diff 0.0 Psig  
Inj Temp 118.3 °F  
Sep Temp 75.8 °F

**Motor**  
Amperage 1.3 Amps

Page 1 2 3 **4**      Generate QR      Menu

Maintenance      User Access      Log off      Help

No Scheduled Maintenance      User admin  
02/01/2002 09:37:58

No Alarm/Trips Present      Run Hours 0

Figure 17-7. Input/Output Screen - Freeze Data Page

## Section 17 • Input / Output

### QR code

This feature generates a QR code containing the values of the present configuration for:

- Standard Analog Input/ Output
- Auxiliary Analog Input/ Output
- Standard Digital Input/ Output
- Auxiliary Digital Input/ Output
- Calculated values

in the future, the Vilter App will be able to read this code and translate it into the information it contains, making it readily available for the user (see Figure 17-8).

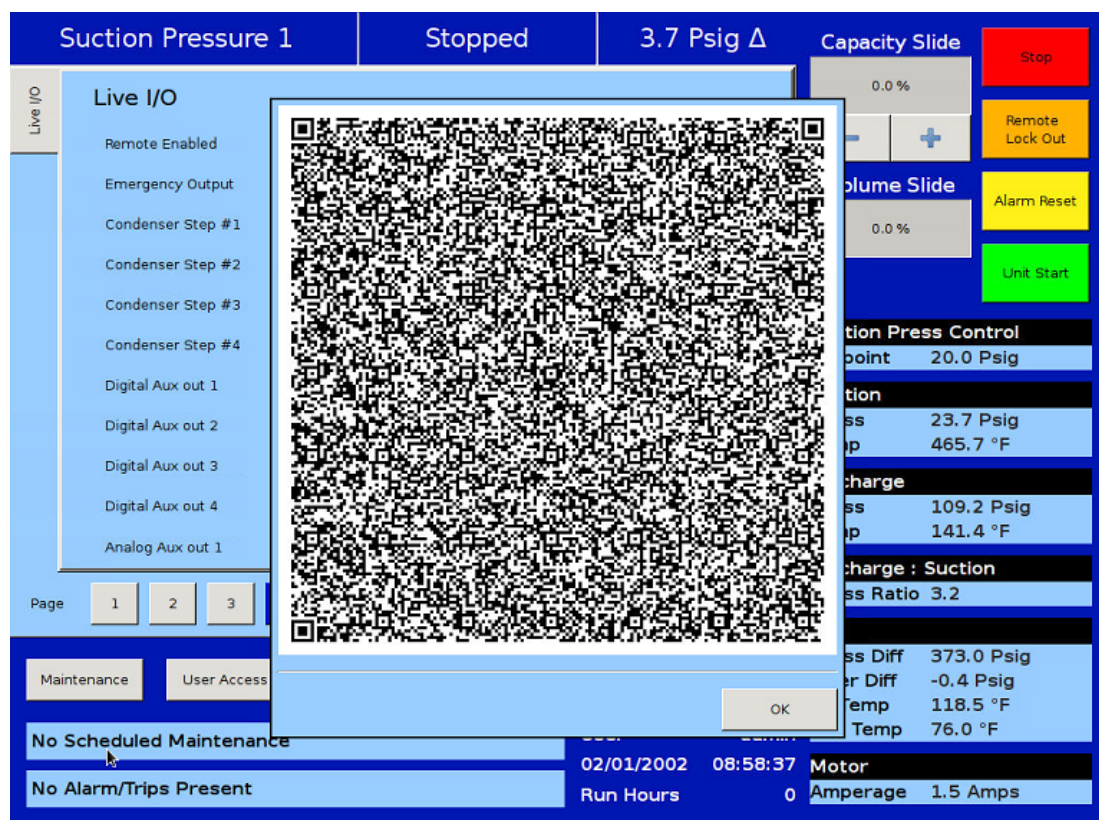

Figure 17-8. QR Code



## Section 18 • Auxiliary Input / Output

### Overview

The Auxiliary Input/Output (I/O) section of the Vission 20/20 gives the operator flexibility to add peripheral instruments and/or devices such as motors, valves and solenoids. With these additions, customer configurable I/Os are useful to expand the functions of the Vission 20/20 where it was not explicitly designed to control.

Setting up one or more of the auxiliary inputs or outputs starts with the configuration screen. In order to enable the auxiliary I/O, the Vission 20/20 must first be equipped with one of the available expandable I/O cards, and the card must be selected on page 6 of the configuration screen. Once the appropriate card is available, then the operator will be permitted to enable and name the desired auxiliary I/O. The operator can then navigate to the Auxiliary I/O screen where the operation of that I/O can be defined.

### Digital Inputs

The Digital Inputs section of the auxiliary I/O allows an operator to configure the auxiliary digital inputs, see Figure 18-1. The digital input can be configured to produce an alarm, a trip, and an inhibit on either a high or

low input. A low input is 0VAC and a high is 120VAC on the enabled input. Leaving all options in their default setting will mean no action will be taken on an enabled input. The input will simply be available to view at the panel or by communications.

Trip/Alarm Check:

- Selecting this checkbox enables the alarms and/or trip functions of the Vission 20/20 for the desired digital input. The accompanying drop-down box gives the operator the flexibility to choose whether the alarm and/or trip occurs if the input is high or low.

Inhibit Check:

- Selecting this checkbox enables the inhibit function of the Vission 20/20 for the desired digital input. An inhibit check prevents the compressor from starting if there exists a condition where a trip will shut down the compressor after it starts. The inhibit can be selected to act on a high or low input and can be selected to work with or without the alarm and trip function.

The screenshot displays the 'Digital Inputs' configuration screen. It features a grid of eight input configurations, each with checkboxes for 'Trip/Alarm Check' and 'Inhibit Check', and a dropdown menu for selecting the input type (None, High, Low). The screen also includes a 'Capacity Slide' and 'Volume Slide' on the right, and a 'Suction Press Control' section with a setpoint of 20.0 Psig. At the bottom, there are navigation buttons (Maintenance, User Access, Log off, Help) and a status bar showing 'No Scheduled Maintenance', 'No Alarm/Trips Present', and system parameters like 'User: admin', 'Run Hours: 0', and 'Motor Amperage: 0.0 Amps'.

Figure 18-1. Auxiliary I/O Screen - Digital Inputs (Page 1)

## Section 18 • Auxiliary Input / Output

### Digital Outputs

The digital outputs section of the Auxiliary I/O screen allows an operator to configure the auxiliary digital outputs, see Figure 18-2. The digital output can be configured to activate (go High, 120VAC) based on either a digital input or a specified level on an analog input. Every digital and analog input in the Vission 20/20 is made available to control a digital output.

#### Analog Input:

- Selecting the Analog Input radio button fills the Active Input drop-down box with all available analog inputs. One of the analog inputs can then be selected to control the digital outputs.

#### Digital Input:

- Selecting the Digital Input radio button fills the Active Input drop-down box with all available digital inputs. One of the digital inputs can then be selected to control the digital outputs.

#### Run Always:

- Selecting this checkbox enables the function that controls the digital output to operate only when the compressor is running or runs all the time.
- N/O & N/C:
  - Choosing the Normally Open (N/O) or Normally Closed (N/C) radio buttons defines what the output will be above or below the trigger value. In the N/O setting, the output will be off (0VAC) while the input value is below the trigger value. In the N/C setting, the output will be high (120VAC) while the input value is below the trigger value.

#### Analog Trigger:

- The analog trigger toggles the digital output based on a specified value plus the specified differential value. These options will be available only when Analog Input is selected.

#### Analog Trigger value:

- This defines the specified value in which the output will toggle. This is an absolute value and not based on units. For example, 100 could mean temperature or pressure depending on the type of input selected.

#### Differential:

- This is the differential around the trigger value. For example, if a trigger value of 100 is entered with a differential of 1, then as the value increases to 101, the output will be triggered. If the value decreases to 99, then the output will be toggled in the opposite direction.

#### Enable Timer:

- Selecting this checkbox enables the function that controls the digital output when activated on the basis of ON Time and OFF Time.

#### Timers:

- ON Time:
  - This defines the ON Time for the digital output when it is activated.
- OFF Time:
  - This defines the OFF Time for the digital output when it is activated.
  - For example, if an analog input is selected with a trigger value of 100 and differential of 1 and ON Time and OFF Time of 1 min each and N/O setting, then as the analog input value increases to 101, the output will be high (120VAC) for 1 min and then the output will be low (0VAC) for 1 min. The output will keep on toggling from high to low and then low to high until the analog input value decreases to 99.

### Analog Inputs

The Analog inputs section of the auxiliary I/O screen allows an operator to define the function of an instrument connected to the Vission 20/20. For Auxiliary Analog Inputs Screens, see Figure 18-3, 18-4 and 18-5. The analog inputs can be configured to simply monitor an input for informational purposes or used as a control input for the auxiliary digital and analog outputs. The analog inputs can also be configured to alarm, trip, and inhibit on specified values.

- Alarm / Trip:
  - This drop-down box allows the operator to select whether the analog input should generate an alarm, trip, or both when the input value exceeds the limits entered into the alarm and trip entry boxes.
- Inhibit:
  - Selecting this checkbox will prevent a start if the input value exceeds the alarm limit values.
- Low Alarm:
  - This defines the lower limit of the input value that when exceeded will generate an alarm.
- High Alarm:
  - This defines the upper limit of the input value, that when exceeded will generate an alarm.

# Section 18 • Auxiliary Input / Output

**Suction Pressure 1** | **Stopped** | **6.2 Psig Δ**

**Digital Outputs**

**Digital Aux out 1**  
 Analog Input  Digital Input  
 Active input: None  
 Run Always  N/O  N/C  
 Analog Trigger Value: 0.0 Diff: 5.0  
 Enable Timer  
 ON Time: 1.0 min OFF Time: 1.0 min

**Digital Aux out 2**  
 Analog Input  Digital Input  
 Active input: None  
 Run Always  N/O  N/C  
 Analog Trigger Value: 0.0 Diff: 5.0  
 Enable Timer  
 ON Time: 1.0 min OFF Time: 1.0 min

**Digital Aux out 3**  
 Analog Input  Digital Input  
 Active input: None  
 Run Always  N/O  N/C  
 Analog Trigger Value: 0.0 Diff: 5.0  
 Enable Timer  
 ON Time: 1.0 min OFF Time: 1.0 min

**Digital Aux out 4**  
 Analog Input  Digital Input  
 Active input: None  
 Run Always  N/O  N/C  
 Analog Trigger Value: 0.0 Diff: 5.0  
 Enable Timer  
 ON Time: 1.0 min OFF Time: 1.0 min

Page 1 2 3 4 5 6 7 Menu

Maintenance User Access Log off Help Panel 1

No Scheduled Maintenance User admin  
 11/07/2014 19:55:09  
 No Alarm/Trips Present Run Hours 0

**Capacity Slide** 0.0% Stop  
 Remote Lock Out  
**Volume Slide** 0.0% Alarm Reset  
 Unit Start

**Suction Press Control**  
 Setpoint 20.0 Psig

**Suction**  
 Press 26.2 Psig  
 Temp 55.0 °F

**Discharge**  
 Press 128.4 Psig  
 Temp 71.5 °F

**Discharge : Suction**  
 Press Ratio 3.5

**Oil**  
 Press Diff 144.0 Psig  
 Filter Diff 9.8 Psig  
 Inj Temp 113.3 °F  
 Sep Temp 110.3 °F

**Motor**  
 Amperage 0.0 Amps

Figure 18-2. Auxiliary I/O Screen - Digital Outputs (Page 2)

**Suction Pressure 1** | **Stopped** | **6.1 Psig Δ**

**Analog Inputs**

**Analog Aux in 1**  
 Alarm / Trip: Neither  Inhibit  
 Low Alarm: 0.0 °F High Alarm: 0.0 °F  
 Low Trip: 0.0 °F High Trip: 0.0 °F  
 Delay: 5 sec

**Analog Aux in 2**  
 Alarm / Trip: Neither  Inhibit  
 Low Alarm: 0.0 °F High Alarm: 0.0 °F  
 Low Trip: 0.0 °F High Trip: 0.0 °F  
 Delay: 5 sec

**Analog Aux in 3**  
 Alarm / Trip: Neither  Inhibit  
 Low Alarm: 0.0 °F High Alarm: 0.0 °F  
 Low Trip: 0.0 °F High Trip: 0.0 °F  
 Delay: 5 sec

**Analog Aux in 4**  
 Alarm / Trip: Neither  Inhibit  
 Low Alarm: 0.0 °F High Alarm: 0.0 °F  
 Low Trip: 0.0 °F High Trip: 0.0 °F  
 Delay: 5 sec

**Analog Aux in 5**  
 Alarm / Trip: Neither  Inhibit  
 Low Alarm: 0.0 °F High Alarm: 0.0 °F  
 Low Trip: 0.0 °F High Trip: 0.0 °F  
 Delay: 5 sec

**Analog Aux in 6**  
 Alarm / Trip: Neither  Inhibit  
 Low Alarm: 0.0 °F High Alarm: 0.0 °F  
 Low Trip: 0.0 °F High Trip: 0.0 °F  
 Delay: 5 sec

Page 1 2 3 4 5 6 7 Menu

Maintenance User Access Log off Help Panel 1

No Scheduled Maintenance User admin  
 11/07/2014 19:57:25  
 No Alarm/Trips Present Run Hours 0

**Capacity Slide** 0.0% Stop  
 Remote Lock Out  
**Volume Slide** 0.0% Alarm Reset  
 Unit Start

**Suction Press Control**  
 Setpoint 20.0 Psig

**Suction**  
 Press 26.1 Psig  
 Temp 55.0 °F

**Discharge**  
 Press 128.4 Psig  
 Temp 71.2 °F

**Discharge : Suction**  
 Press Ratio 3.5

**Oil**  
 Press Diff 144.2 Psig  
 Filter Diff 9.5 Psig  
 Inj Temp 113.7 °F  
 Sep Temp 110.1 °F

**Motor**  
 Amperage 0.0 Amps

Figure 18-3. Auxiliary I/O Screen - Analog Inputs (Page 3)

## Section 18 • Auxiliary Input / Output

- Low Trip:
  - Defines the lower limit of the input value that when exceeded will generate a trip.
- High Trip:
  - Defines the upper limit of the input value that when exceeded will generate a trip.
- Delay:
  - Defines the time period for which input value is checked with alarm/trip setpoints before showing alarm or trip. If the input value is continuously above or below the alarm or trip setpoints, only then an alarm or trip is generated.

### Analog Outputs

This screen gives the ability to map any standard analog input or auxiliary input to any of the four analog auxiliary outputs. There are two pages of auxiliary output configuration; each consists of two analog auxiliary outputs. For Auxiliary Outputs Screens, see Figures 18-6 and 18-7.

- Active Input:
  - The active Input can be selected from the available standard analog inputs or auxiliary inputs. The selected Active Input gets mapped to auxiliary output.
- Run Always:
  - “Run Always” option can be selected to enable the mapped auxiliary output irrespective of the compressor’s run state. If “Run Always” is not selected then the mapped auxiliary output is enabled only when the compressor is running.
- Trigger:
  - Trigger configuration is used to enable / disable an auxiliary output according to the configured trigger input. The trigger input can be selected from the available standard analog inputs, auxiliary analog inputs or digital inputs. Trigger value and differential in combination with trigger type (“enable if above / On” or “enable if below / Off”) enables or disables the auxiliary output.

### Control

Auxiliary outputs can be PID Controlled or Scalable Controlled.

PID Control:

P = Proportional (gain):

- Used to adjust the auxiliary output in direct proportion to the difference between the control setpoint and the active input. The proportional term is a unitless quantity and is used for coarse adjustment. This setpoint should be set to the lowest value that gives adequate control system response. Increasing the proportional setting increases the control system’s sensitivity to small process fluctuations and the tendency to hunt.

I = Integral (reset):

- Used to integrate the error over time, to account for a small error that has persisted for a long time. This quantity is used for fine adjustment. This setpoint is used to smooth out process variations. This setpoint should be set high enough to prevent hunting but not too high or it will cause control system overshoot.

D = Derivative (rate):

- Used to account for how fast the error is changing, positively or negatively.

Setpoint :

- Setpoint used by PID engine.

Inverse:

- This option is used to inverse an Analog Aux Output , to vary its output from 20 mA to 4 mA. Typically used where normally open solenoids are to be operated.

Negative Error:

- The negative Error option is used when PID should be active only if a negative error is present (Setpoint is greater than Process Variable).

Scalable Control:

- Minimum Input / Maximum Input:
  - These setpoints define minimum and maximum Input range for a configured active input .
- Minimum Output / Maximum Output:
  - These setpoints define minimum and maximum output. The Auxiliary output produces a linear value based on these settings.



# Section 18 • Auxiliary Input / Output

**Suction Pressure 1**      **Stopped**      **6.0 Psig Δ**

**Analog Inputs (cont.)**

**Analog Aux in 7**  
 Alarm / Trip: Neither  Inhibit  
 Low Alarm: 0.0 °F    High Alarm: 0.0 °F  
 Low Trip: 0.0 °F    High Trip: 0.0 °F  
 Delay: 5 sec

**Analog Aux in 10**  
 Alarm / Trip: Neither  Inhibit  
 Low Alarm: 0.0 °F    High Alarm: 0.0 °F  
 Low Trip: 0.0 °F    High Trip: 0.0 °F  
 Delay: 5 sec

**Analog Aux in 8**  
 Alarm / Trip: Neither  Inhibit  
 Low Alarm: 0.0 °F    High Alarm: 0.0 °F  
 Low Trip: 0.0 °F    High Trip: 0.0 °F  
 Delay: 5 sec

**Analog Aux in 11**  
 Alarm / Trip: Neither  Inhibit  
 Low Alarm: 0.0 °F    High Alarm: 0.0 °F  
 Low Trip: 0.0 °F    High Trip: 0.0 °F  
 Delay: 5 sec

**Analog Aux in 9**  
 Alarm / Trip: Neither  Inhibit  
 Low Alarm: 0.0 °F    High Alarm: 0.0 °F  
 Low Trip: 0.0 °F    High Trip: 0.0 °F  
 Delay: 5 sec

**Analog Aux in 12**  
 Alarm / Trip: Neither  Inhibit  
 Low Alarm: 0.0 °F    High Alarm: 0.0 °F  
 Low Trip: 0.0 °F    High Trip: 0.0 °F  
 Delay: 5 sec

Page: 1 2 3 **4** 5 6 7      Menu

Maintenance    User Access    Log off    Help      Panel 1

No Scheduled Maintenance      User: admin  
 11/07/2014 19:58:19  
 No Alarm/Trips Present      Run Hours: 0

**Capacity Slide**  
 0.0 %    Stop  
 -    +    Remote Lock Out

**Volume Slide**  
 0.0 %    Alarm Reset  
 Unit Start

**Suction Press Control**  
 Setpoint: 20.0 Psig

**Suction**  
 Press: 26.0 Psig  
 Temp: 55.2 °F

**Discharge**  
 Press: 128.6 Psig  
 Temp: 71.5 °F

**Discharge : Suction**  
 Press Ratio: 3.5

**Oil**  
 Press Diff: 144.2 Psig  
 Filter Diff: 9.8 Psig  
 Inj Temp: 113.5 °F  
 Sep Temp: 110.1 °F

**Motor**  
 Amperage: 0.0 Amps

Figure 18-4. Auxiliary I/O Screen - Analog Inputs (Page 4)

**Suction Pressure 1**      **Stopped**      **6.0 Psig Δ**

**Analog Inputs (cont.)**

**Analog Aux in 13**  
 Alarm / Trip: Neither  Inhibit  
 Low Alarm: 0.0 °F    High Alarm: 0.0 °F  
 Low Trip: 0.0 °F    High Trip: 0.0 °F  
 Delay: 5 sec

**Analog Aux in 15**  
 Alarm / Trip: Neither  Inhibit  
 Low Alarm: 0.0 °F    High Alarm: 0.0 °F  
 Low Trip: 0.0 °F    High Trip: 0.0 °F  
 Delay: 5 sec

**Analog Aux in 14**  
 Alarm / Trip: Neither  Inhibit  
 Low Alarm: 0.0 °F    High Alarm: 0.0 °F  
 Low Trip: 0.0 °F    High Trip: 0.0 °F  
 Delay: 5 sec

**Analog Aux in 16**  
 Alarm / Trip: Neither  Inhibit  
 Low Alarm: 0.0 °F    High Alarm: 0.0 °F  
 Low Trip: 0.0 °F    High Trip: 0.0 °F  
 Delay: 5 sec

Page: 1 2 3 4 **5** 6 7      Menu

Maintenance    User Access    Log off    Help      Panel 1

No Scheduled Maintenance      User: admin  
 11/07/2014 19:59:27  
 No Alarm/Trips Present      Run Hours: 0

**Capacity Slide**  
 0.0 %    Stop  
 -    +    Remote Lock Out

**Volume Slide**  
 0.0 %    Alarm Reset  
 Unit Start

**Suction Press Control**  
 Setpoint: 20.0 Psig

**Suction**  
 Press: 26.0 Psig  
 Temp: 54.6 °F

**Discharge**  
 Press: 128.5 Psig  
 Temp: 70.8 °F

**Discharge : Suction**  
 Press Ratio: 3.5

**Oil**  
 Press Diff: 144.1 Psig  
 Filter Diff: 9.9 Psig  
 Inj Temp: 113.3 °F  
 Sep Temp: 110.1 °F

**Motor**  
 Amperage: 0.0 Amps

Figure 18-5. Auxiliary I/O Screen - Analog Inputs (Page 5)

# Section 18 • Auxiliary Input / Output

**Suction Pressure 1**      **Stopped**      **6.1 Psig Δ**

**Analog Outputs**

**Analog Aux out 1**  
 Standard Input    Auxiliary Input  
 Run Always   Active Input: None  
 Trigger  
 Trigger Input:  Analog Input    Digital Input  
 None   Enable If Above / 0  
 Trigger Value: 0.0   Differential: 2.0

**Analog Aux out 2**  
 Standard Input    Auxiliary Input  
 Run Always   Active Input: None  
 Trigger  
 Trigger Input:  Analog Input    Digital Input  
 None   Enable If Above / 0  
 Trigger Value: 0.0   Differential: 2.0

**Control Method**  
 PID Control    Scalable Control  
 P (Gain): 0.0   Min Input: 4.0   Min Output: 4.0  
 I (Reset): 0.0  
 D (Rate): 0.0   Max Input: 20.0   Max Output: 20.0  
 Setpoint: 0.0  
 Inverse    Negative Error

Page: 1 2 3 4 5 **6** 7      Menu

Maintenance   User Access   Log off   Help      **Panel 1**

**No Scheduled Maintenance**      User: admin  
**No Alarm/Trips Present**      11/07/2014 20:00:51  
 Run Hours: 0

**Capacity Slide** 0.0%   **Stop**  
 -   +   **Remote Lock Out**

**Volume Slide** 0.0%   **Alarm Reset**  
**Unit Start**

**Suction Press Control**  
 Setpoint: 20.0 Psig

**Suction**  
 Press: 26.1 Psig  
 Temp: 54.6 °F

**Discharge**  
 Press: 128.6 Psig  
 Temp: 71.5 °F

**Discharge : Suction**  
 Press Ratio: 3.5

**Oil**  
 Press Diff: 143.8 Psig  
 Filter Diff: 10.0 Psig  
 Inj Temp: 113.5 °F  
 Sep Temp: 110.1 °F

**Motor**  
 Amperage: 0.0 Amps

Figure 18-6. Auxiliary I/O Screen - Analog Outputs (Page 6)

**Suction Pressure 1**      **Stopped**      **6.1 Psig Δ**

**Analog Outputs (cont.)**

**Analog Aux out 3**  
 Standard Input    Auxiliary Input  
 Run Always   Active Input: None  
 Trigger  
 Trigger Input:  Analog Input    Digital Input  
 None   Enable If Above / 0  
 Trigger Value: 0.0   Differential: 2.0

**Analog Aux out 4**  
 Standard Input    Auxiliary Input  
 Run Always   Active Input: None  
 Trigger  
 Trigger Input:  Analog Input    Digital Input  
 None   Enable If Above / 0  
 Trigger Value: 0.0   Differential: 2.0

**Control Method**  
 PID Control    Scalable Control  
 P (Gain): 0.0   Min Input: 4.0   Min Output: 4.0  
 I (Reset): 0.0  
 D (Rate): 0.0   Max Input: 20.0   Max Output: 20.0  
 Setpoint: 0.0  
 Inverse    Negative Error

Page: 1 2 3 4 5 6 **7**      Menu

Maintenance   User Access   Log off   Help      **Panel 1**

**No Scheduled Maintenance**      User: admin  
**No Alarm/Trips Present**      11/07/2014 20:02:13  
 Run Hours: 0

**Capacity Slide** 0.0%   **Stop**  
 -   +   **Remote Lock Out**

**Volume Slide** 0.0%   **Alarm Reset**  
**Unit Start**

**Suction Press Control**  
 Setpoint: 20.0 Psig

**Suction**  
 Press: 26.1 Psig  
 Temp: 54.8 °F

**Discharge**  
 Press: 128.4 Psig  
 Temp: 71.2 °F

**Discharge : Suction**  
 Press Ratio: 3.5

**Oil**  
 Press Diff: 144.3 Psig  
 Filter Diff: 9.4 Psig  
 Inj Temp: 113.7 °F  
 Sep Temp: 110.3 °F

**Motor**  
 Amperage: 0.0 Amps

Figure 18-7. Auxiliary I/O Screen - Analog Outputs (Page 7)

## Section 19 • Configuration

### Overview

The configuration screen is where most of the Vission 20/20 features are enabled and configured. The initial setup of the Vission 20/20 will generally start here, see Figure 19-1. Depending on what is selected, different portions of the Vission 20/20 will be available to the operator.

### Compressor Identification

This section sets the identification for a Vission 20/20 unit.

Name:

- Unique identifier that is used for all Vission 20/20 units.

Panel ID:

- Panel Identifier used by the controller when communicating with multiple panels.

### Units

This section sets how values will be represented throughout the program.

Temp Units:

- Drop-down box to select the temperature units from Fahrenheit and Celsius. Once selected, all screen temperatures will be displayed in the chosen units.

Press Units:

- Drop-down Box to select the pressure units. Psig, Bar, and Kpa are the possible selections and the units will be displayed for every pressure value throughout the screens.

Order Num:

- Identifies the Order number of the purchase of the compressor. This Number will be needed if the operator requires help from Vilter™.

Run Hours:

- Offers the ability to change the compressor run

**Compressor Identification**

Name:

Panel ID:

Temp. Units:

Press. Units:

Order Num.:

Run Hours:

**Time**

Format

24 hour

12 hour

Current

Hour:

Minute:

Second:

**Date**

Year:

Month:

Day:

**Communications**

Active Remote Control:

**On Communication Failure**

Direct I/O

Run Permissive

Serial (Modbus RTU)

Node Address:

Port:

Baud Rate:

Data Bits:  8

Stop Bits:  1  2

Parity:

Ethernet

IP Address:

Subnet Mask:

Gateway:

Protocol:

Node Address:

**VNC Account**

New Password:

Verify New Password:

Port Number:

Enable Web Browser Access

Browser Port Number:

**Anti-Recycle**

**Restart on Power Failure**

Always

Never

Timed

Remote Lock Off

Boot in Remote (Direct I/O)

Compressor Sequencing

Master

Slave

Network Name:

**Language**

Page:

Figure 19-1. Configuration Screen - Initial Setup (Page 1)

## Section 19 • Configuration

---

hours. This is typically used when replacing an older micro controller on an existing compressor with a new Vission 20/20.

### Time & Date

This section sets the time and date of the Vission 20/20. Accurate time and date are essential for accurate logging and troubleshooting. Setting these parameters will set the hardware clock embedded in the Vission 20/20 CPU. If the time is not retained after powering down the panel, the operator should check and/or replace the coin style battery on the panel SBC behind the touchscreen.

Format:

- Selection to choose between 12 hour or 24 hours clock.

Hour:

- Entry box to set the clock hours. AM or PM drop-down box will available if the 12 hour format is selected.

Minute:

- Entry Box to set the clock minutes.

Second:

- Entry Box to set the clock seconds.

Year:

- Entry Box to set the current year.

Month:

- Entry Box to set the current month.

Day:

- Entry Box to set the current date.

### Communications

The communication section is the control center for all communications to the Vission 20/20 panel. It is possible to have multiple modes of communications enabled and used. However, only one mode can be used to control the Vission 20/20, which would be the one selected in the “Active Remote Control” drop-down box. For a complete list of communication registers, please refer to the Vission 20/20 communication table.

Active Remote Control:

- Selects the mode of remote control. The operator can select between Direct I/O, Serial, or Ethernet.

On Communication Failure

- This feature of the Vission 20/20 offers the ability to

define how the Vission 20/20 will handle a communication failure.

- a) Revert to Local Control:
  - Once the compressor has been running in Remote mode, a communication failure detection timer, as configured in the Timers screen, will start. If no further communication with the 20/20 takes place for the configured time, the 20/20 will be placed in Local Auto mode, a yellow banner will be displayed on the 20/20's screen to show that a “Remote Comm Time-out” occurred, and the Event List will get populated with a time-stamped “Remote Comm Time-out” event.
- b) Stop Compressor with Trip:
  - Once the compressor has been running in Remote mode, a communication failure detection timer, as configured in the Timers screen, will start. If no further communication with the 20/20 takes place for the configured time, the 20/20 will be stopped, a red banner will be displayed on the 20/20's screen to show that a “Remote Comm Time-out” occurred, and the Event List will get populated with a time-stamped “Remote Comm Time-out” event.

### Direct I/O

Enables the Direct I/O inputs. Once selected, a pop-up will be displayed and the operator will need to choose one of the three Direct I/O options

### Run Permissive

- When this checkbox is enabled, it monitors the Remote Start/Stop Digital Input (6th Digital Input on Digital Input Board 1). If this digital input is energized, the Compressor is allowed to start in the selected run mode (Auto / Manual / Remote). If the Remote Start/Stop digital input is de-energized the compressor will wait until the Digital Input is Energized.

- When this checkbox is disabled, the Remote Start/Stop Digital Input State is not monitored during Compressor Start

## Section 19 • Configuration

---

### Serial (Modbus RTU)

Enables the Serial Modbus RTU protocol. Once selected, the remainder of the serial setpoints will be available for editing.

Node Address:

- Address used by the controller when communicating with multiple panels.

Port:

- The Vission 20/20 has two ways to communicate on serial bus. Either via the built in serial port, P12, or through one of the USB ports. This drop-down box allows the operator to choose which one will be used.

Baud Rate:

- Sets the Baud Rate for the serial communication.

Data Bits:

- Fixed at 8 Data bits.

Stop Bits:

- Identifies the end of character for re-synchronizing.

Parity:

- Identifies the type of error detection.

### Ethernet

Enables the Ethernet port. Once selected, the remainder of the Ethernet setpoints will be available for editing.

IP Address:

- Entry box to set the IP address.

Subnet Mask:

- Entry box to set the Subnet Mask.

Gateway:

- Entry box to set the Gateway address.

Protocol:

- Drop-down box to select the type of protocol used to remotely control the Vission 20/20.

Node Address:

- Address used by the controller when communicating with multiple panels.

### VNC Account

Vission 20/20 panels can be accessed remotely by using a VNC client over TCP/IP network. This section allows the operator to change default VNC Password and VNC Port number, Enable Web browser access and change the browser port number, see Figure 19-1.

New Password:

- The operator will add the password by touching the entry box and typing the password via the pop-up keyboard.

Verify New Password:

- The operator will re-enter the password by touching the entry box and typing the password via the pop-up keyboard.

Port Number:

- The operator will change the port number for VNC server by touching the entry box and typing via the pop-up keyboard. Default port number is 5900. Operator can assign port number ranging from 5900 to 6000.

Enable Web Browser Access

- Enables the web browser access for Vission 20/20 Panels. Once selected, the Browser Port Number will be available for editing.

Browser Port Number:

- The operator will change the browser port number for the VNC server by touching the entry box and typing via the pop-up keyboard. The default port number is 5901. The operator can assign port numbers ranging from 5901 to 6000.

Notes:

1. Port Number and Browser Port Number cannot have the same value.
2. When Web Browser access is enabled then SSVNC desktop client will be required to connect to the VNC server from a desktop machine.
3. When web browser access is not enabled any normal VNC client can be used to connect to a Vission 20/20.
4. Web browser (Internet Explorer, Firefox, Google Chrome, Edge, Safari, etc.) should be Java Enabled to access Vission 20/20 Panels.
5. Currently only Java Version 6 and below is supported when accessing Vission 20/20 Panels over Web browser.

### Anti-Recycle

Anti-Recycle defines the method of motor protection due to repeated motor starts. The operator has 3 choices of protection. “Hot starts” allow only a certain number of starts per hour before setting the anti-recycle timer to one hour. The number of starts is set in the timer page. “Accumulative” immediately adds time to the anti-recycle timer once the compressor is started and the time can be set in the timers screen. “True anti-recycle” adds to the anti-recycle timer once the compressor is shut-down. The motor of the compressor cannot be restarted if there is anti-recycle time left, and the operator can view this time on the top left corner of the main screen.

### Restart On Power Failure

This feature of the Vission 20/20 offers the ability to define how the Vission 20/20 will handle a power failure. This can also be useful to allow a system controller to regain control of the Vission panel without the need of operator intervention.

Always:

- When selected, initiates a start after the panel powers back up after a power failure, but only if the compressor was running before the power failure and starts the compressor in Auto mode.

Never:

- When selected, prevents any automatic action once the panel powers back up after a power failure.

Timed:

- When selected, initiates a start after the panel powers back up after a power failure and the operator-set timer runs out. When there are multiple compressors in a larger system, it is recommended for the operator to give each compressor a different start time. A restart will only occur if the compressor was running before the power failure and starts the compressor in Auto mode.

Remote Lock Off:

- When selected, turns the remote lock out off when the panel powers up. Select this option if the operator wishes a system controller to regain control of the Vission 20/20 without human interference.

Boot in Remote (Direct I/O):

- When selected, places the panel into Remote mode when the panel powers up. Select this option when under Direct I/O control and the system controller is to gain control of the Vission 20/20 without human interference.

## Section 19 • Configuration

### Compressor Sequencing

The compressor sequencing feature of the Vision 20/20 allows the operator to setup as many as five compressors to automatically start, stop and maintain system loads. The compressor designated as the master will monitor system parameters and make decisions on how many compressors are required to meet the load as efficiently as possible.

Compressor Sequencing:

- Enables the compressor sequencing algorithms and allows access to the compressor sequencing screen.

Master:

- Identifies the panel as the master while in sequencing control.

Slave:

- Identifies the panel as a slave while in sequencing

control.

Compressor Name:

- Unique identifier that is broadcasted to all other Vision 20/20 units in the sequencing network.

### Language

Allows the operator to select the language to be displayed on screen.

### Model & Refrigerant

The values in this section provide the Vision 20/20 algorithm critical information on how to efficiently and safely control the compressor, see Figures 19-2 and 19-3 & 19-4.

Compressor: VSS  
Model: 451  
Refrigerant: R717

**Compressor Control**

# Controllers

Suction Pressure Control 2  
 Process Control 1  
 Temperature  
 Pressure  
 Discharge Pressure Control 1

**Optional Function Selection**

Compressor VFD  
 Oil Restriction Solenoid

**Superheat**

Suction Superheat Monitor  
 Discharge Superheat Monitor

**Condenser Control**

Ambient Sensor  
 Wetbulb Sensor  
 VFD Fan

**Touchscreen**

Calibrate  
Washdown  
 Screen Saver  
 Display Background Image

**Motor Current Device**

Current Transformer  
 4-20ma Transmitter

**Alarms and Trips**

Idle Time Trip

**Daily Auto Backup Settings**

Time  
Hour: 12 AM  
Minute: 0

**Oil Pump**

No Pump  
 Cycling  
 Full Time

**Oil Cooling**

Thermosyphon  
 H2O Oil Cooler  
 Liquid Injection  
 Solenoids  
 Motorized Valve  
 Remote Oil Cooler  
 VFD Fan

Page: 1 2 3 4 5 6 7 8 Apply Close

Figure 19-2. Configuration Screen - Compressor Control (Page 2)  
(Compressor Type – VSS)



## Section 19 • Configuration

---

Compressor:

- Drop-down box to select the compressor type. This selection is critical for proper volume slide control.

Model:

- Drop-down box to select the compressor size. This selection is critical for proper volume slide control. When the selection is VRS, such as in Figure 19-3, the “Model” option becomes the compressor’s CFM.

Refrigerant:

- Drop-down box to select the type of refrigerant. This selection is critical for proper volume slide control.

### Compressor Control

Vilter™ compressors typically run in one of three control modes: Suction Pressure, Process Temperature or Discharge Pressure Control, see Figure 19-2. Discharge Pressure Control is mutually exclusive with Suction Pressure Control & Process Control. When Discharge Pressure Control is selected, Suction Pressure Control and Process Control are grayed out and cannot be selected. Similarly if Suction Pressure Control and/or Process Control are selected, Discharge Pressure Control is grayed out and cannot be selected.

Suction Pressure Control:

- This defines the Suction Pressure input as the process variable and all controls will be based on Suction Pressure. The operator has the option to select up to two controllers where each can have its own set of setpoints.

Process Control:

- This defines the Process Control input as the process variable and all controls will be based on either Process Temperature or Process Pressure. The operator has the option to select up to two controllers where each can have its own set of setpoints. The operator has to select one of the process control modes, either temperature or pressure, as a process variable. Temperature and pressure configurations are mutually exclusive. The default setting will have temperature as process control variable.

Discharge Pressure Control:

- This defines the discharge pressure input as the process variable and all controls will be based on discharge pressure. The operator has the option to

select up to two controllers where each can have its own set of setpoints.

### Optional Function Selection

The following options are additional features of the Vission 20/20 that can be selected. Some of these options will not be available for selection unless the proper I/O cards are installed and enabled, see Figure 19-2.

Compressor VFD:

- Enables the compressor motor’s VFD option.

Oil Restriction Solenoid:

- Enables the Oil Restriction Solenoid option.

Suction Superheat Monitor:

- Enables the suction superheat safety algorithms. Suction superheat monitor works only with R717 and R507. Suction superheat monitor and Discharge superheat monitor features are mutually exclusive.

Discharge Superheat Monitor:

- Enables the discharge superheat safety algorithms. Discharge superheat monitor works only with R717. Discharge superheat monitor and suction superheat monitor features are mutually exclusive.

### Condenser Control

The set of values in this section enables the condenser control feature of the Vission 20/20. Once selected the checkboxes will become available for selection and the condenser control screen will be available via the menu screen. Some of the options’ check boxes in this section may not be available for selection unless the proper I/O cards are installed and enabled, see Figures 19-2 and 19-3.

Ambient Sensor:

- Enables the ambient temperature option for the condenser control algorithm.

Wetbulb Sensor:

- Enables the wetbulb temperature override option for the condenser control algorithm.

VFD Fan:

- Enables the VFD output option for the condenser control algorithm.



## Section 19 • Configuration

### Touchscreen

The “Calibrate” button puts the screen into calibration mode. Calibrating the touchscreen is only required if the operator finds that the pointer’s arrow no longer follows his finger. The calibration mode requires the operator to touch the four corners of the touchscreen and then the Accept button.

The “Washdown” button will “blank” the screen for 30 seconds. Once this time elapses, a “Close” button will appear to close the blank screen.

Screen Saver check box:

- Enables the option for the Screen Saver.
- The default State of the check box is Enabled.
- If the check box is enabled, then after 15 minutes of inactivity, a blank screen will be displayed as a screen

saver.

- If the check box is disabled, then the blank Screen will not be displayed.

Display Background Image:

- The default State of the check box is Enabled.
- If the check box is enabled, then the Main Screen will show the compressor Image and its related parameters.
- If the check box is disabled, the Main Screen will not show the Compressor’s Image, instead it will only show compressor related parameters. The table at top left corner will be fixed at the Digital Output table and the other three will be user configurable tables.

Compressor: VRS  
CFM: 600  
Refrigerant: R717

**Compressor Control** # Controllers

Suction Pressure Control 2  
 Process Control 1  
• Temperature  
• Pressure  
 Discharge Pressure Control 1

**Optional Function Selection**

Compressor VFD  
 Oil Restriction Solenoid

**Superheat**

Suction Superheat Monitor  
 Discharge Superheat Monitor

**Condenser Control**

Ambient Sensor  
 Wetbulb Sensor  
 VFD Fan

**Touchscreen**

Calibrate  
Washdown  
 Screen Saver  
 Display Background Image

**Oil Pump**

No Pump  
 Cycling  
 Full Time

**Oil Cooling**

Thermosyphon  
 H2O Oil Cooler  
 Liquid Injection  
• Solenoids  
 Motorized Valve  
 Remote Oil Cooler  
 VFD Fan

**Motor Current Device**

Current Transformer  
 4-20ma Transmitter

**Alarms and Trips**

Idle Time Trip

**Daily Auto Backup Settings**

Time  
Hour: 12 AM  
Minute: 0

Page: 1 2 3 4 5 6 7 8 Apply Close

Figure 19-3. Configuration Screen - Compressor Control (Page 2)  
(Compressor Type – VRS)

## Section 19 • Configuration

---

### Oil Pump

This section defines how the Vission 20/20 will control the oil pump, see Figures 19-2 and 19-3.

No Pump:

- The Oil Pump digital output will be turned off.

Stal:

- This option is only available for VRS. The Oil pump is cycled on and off depending on compressor's differential pressure. See Figure 19-3.

Cycling:

- Enables the option to cycle the oil pump. The Oil pump is cycled on and off depending on compressor's differential pressure.

Full Time:

- Enables the option for full time oil pump. The Oil pump will always be running while the compressor is running.

### Oil Cooling

The section defines how the Vission 20/20 will monitor and/or control the temperature of the compressor oil, see Figures 19-2 and 19-3.

Thermosyphon:

- This defines the compressor oil cooling method as thermosyphon.

H2O Oil Cooler:

- This defines the compressor oil cooling method as water heat exchange.

Liquid Injection:

- This defines the compressor oil cooling method as liquid refrigerant injection.

Solenoids:

- Enables the solenoid for liquid injection control.

Motorized Valve:

- Enables the motorized valve for liquid injection controlled by PID settings.

Remote Oil Cooler:

- Defines the compressor oil cooling method as Remote Oil Cooler. A Remote Oil Cooler VFD fan can be enabled when the Auxiliary Output board is installed and enabled. The rest of the Remote Oil

Cooler setpoints can be defined by navigating to the Remote Oil Cooler Screen. The Remote Oil Cooler and Condenser Control feature are mutually exclusive.

### Motor Current Device

The Vission 20/20 can read the motor current in a couple of different ways. The following selections define the method, see Figures 19-2 and 19-3.

Current Transformer:

- This defines the input used for motor current when a current transformer is used.

4-20mA Transformer:

- This defines the input used for motor current.

### Alarms and trips

The “Idle time trip” check box works in conjunction with the High Level Shutdown digital input. If selected, when the compressor is in idle state and this digital input is off, the compressor should give a “High Level Shutdown Trip” message.

### Special Compressor Settings

The following options are special features of the Vission 20/20 that can be only configured by a Vilter™ user, see Figure 19-4.

Cool Compression:

- Enables Cool Compression Algorithm to cool oil. A blanket of liquid ammonia is used on top of oil in the Oil Separator.

Rapid Cycling VFD:

- Enables the Rapid Cycling VFD Algorithm to control the Compressor VFD Analog Output.

Suction Oil Injection Solenoid:

- Enables the SOI Solenoid Algorithm. A SOI Solenoid is used when the Oil Pump is not present in the system.

Oil Flow Control:

- Enables the option for oil flow control. Oil flow control will vary the analog output to control the Danfoss valve's opening % depending on the capacity slide position. The Oil flow control output will be regulated only when the compressor is running and the start condition is over, i.e. low oil pressure timer is elapsed,

## Section 19 • Configuration

pumpdown control operation is not running and oil injection temperature is above the oil injection temperature override setpoint. If any of the above conditions are not satisfied, then the oil flow analog output will be 4mA, which corresponds to 100 % valve open.

Heat Pump:

- Enables the option for Heat Pump. The maintenance Schedule for a Heat Pump Compressors is different & hence the maintenance Chart is modified when the Heat Pump option is selected

Discharge Pressure (Psig):

- This setpoint defines a value for the Discharge Pressure. This is typically used to determine the service interval to Inspect a compressor's Maintenance Item in the Maintenance Chart Page of the Maintenance Screen.

Differential Pressure (Psig):

- This setpoint defines the value for the Differential Pressure. This is typically used to determine the service interval to Inspect a compressor's Maintenance Item in the Maintenance Chart Page of the Maintenance Screen.

### Daily Auto Backup Settings

The Vission 20/20 can backup the database every day at a configured time. The following section defines the time setpoints for database backup activity, see Figure 19-4.

Hour:

- Entry box to set the database backup hours. AM or PM drop-down box will be available if the 12 hour format is selected.

The screenshot displays the 'Special Compressor Settings' section of the configuration interface. It includes several sub-sections with various controls:

- Compressor:** VSS (dropdown), Model 451 (dropdown), Refrigerant R717 (dropdown).
- Compressor Control:** Suction Pressure Control (checked, 1), Process Control (unchecked, 1), Temperature (selected), Pressure (radio), Discharge Pressure Control (unchecked, 1).
- Optional Function Selection:** Compressor VFD (unchecked), Oil Restriction Solenoid (unchecked).
- Superheat:** Suction Superheat Monitor (unchecked), Discharge Superheat Monitor (checked).
- Condenser Control:** Ambient Sensor (unchecked), Wetbulb Sensor (unchecked), VFD Fan (unchecked).
- Touchscreen:** Calibrate, Washdown, Screen Saver (checked), Display Background Image (checked).
- Oil Pump:** No Pump (selected), Cycling, Full Time.
- Oil Cooling:** Thermosyphon, H2O Oil Cooler, Liquid Injection (selected), Solenoids (selected), Motorized Valve, Remote Oil Cooler, VFD Fan (unchecked).
- Motor Current Device:** Current Transformer (selected), 4-20ma Transmitter (radio).
- Alarms and Trips:** Idle Time Trip (unchecked).
- Special Compressor Settings:** Cool Compression (unchecked), Rapid Cycling VFD (unchecked), Suction Oil Injection Solenoid (unchecked), Oil Flow Control (unchecked), Heat Pump (checked), Discharge Pressure (Psig) 460, Differential Pressure (Psig) 380.
- Daily Auto Backup Settings:** Time: Hour 12, AM (dropdown), Minute 0.

At the bottom, there is a page navigation bar (Page 1-6) and 'Apply' and 'Close' buttons.

Figure 19-4. Configuration Screen - Compressor Control (Page 2)  
(Special Compressor Settings)

## Section 19 • Configuration

Minute:

- Entry box to set database backup minutes.

### Configurable Main Screen Settings

Configuration screen's pages 3 and 4 will allow users to configure parameters to display on the Main Screen. These pages will be available for selection only if the Display Background Image option is Disabled.

Name:

- Entry box to set the name of the table which is displayed on Main Screen.

Each row will have two combo boxes. The first combo box will have options to select the type of value to be displayed on the Main Screen, i.e. Standard Analog / Digital Inputs & Outputs, Auxiliary Analog / Digital Inputs & Outputs or Calculated Values. Based on the first combo box selection, the second combo box will show list of values for selection. The value set from the second

combo-box will get displayed on Main Screen

Table 1 will have 12 different rows for the selected data to be displayed on the Main Screen. Table 2 & 3 will have 8 different rows for the selected data to be displayed on the Main Screen. Please see Figures 19-5 & 19-6.

### Digital Inputs

The Vission 20/20 has several Digital inputs for which the operator can choose the use. Once an input is enabled, the Auxiliary I/O screen will be available from the menu screen where the operator can further define the input's operation, see Figure 19-7 and also reference Section 18.

Enable Input #:

- Enables the selected digital input.

Set Name:

- Allows the operator to assign a name to the input.

The screenshot shows a configuration window titled "Configurable Main Screen Settings". At the top, there is a section for "Table 1" with a "Name" input field. Below this, there are 12 rows, each labeled "Row 1" through "Row 12". Each row contains two dropdown menus. The first dropdown menu in each row is set to "Standard Analog Input/Output", and the second is set to "None". At the bottom of the window, there is a "Page" indicator showing "1 2 3 4 5 6 7 8", with "3" highlighted. To the right of the page indicator are "Apply" and "Close" buttons.

Figure 19-5. Configuration Screen – Configurable Main Screen Settings (Page 3)

### Analog Inputs

The Vision 20/20 has several Analog inputs for which the operator can choose the use. Once an input is enabled, the Auxiliary I/O screen will be available from the menu screen where the operator can further define the input's operation, see Figure 19-8 and also reference Section 18.

Enable Input #:

- Enables the selected analog input.

Set Name:

- Allows the operator to assign a name to the input.

**Configurable Main Screen Settings (cont.)**

**Table 2**  
Name

<b>Row 1</b> Standard Analog Input/Output ▼ None ▼	<b>Row 5</b> Standard Analog Input/Output ▼ None ▼
<b>Row 2</b> Standard Analog Input/Output ▼ None ▼	<b>Row 6</b> Standard Analog Input/Output ▼ None ▼
<b>Row 3</b> Standard Analog Input/Output ▼ None ▼	<b>Row 7</b> Standard Analog Input/Output ▼ None ▼
<b>Row 4</b> Standard Analog Input/Output ▼ None ▼	<b>Row 8</b> Standard Analog Input/Output ▼ None ▼

**Table 3**  
Name

<b>Row 1</b> Standard Analog Input/Output ▼ None ▼	<b>Row 5</b> Standard Analog Input/Output ▼ None ▼
<b>Row 2</b> Standard Analog Input/Output ▼ None ▼	<b>Row 6</b> Standard Analog Input/Output ▼ None ▼
<b>Row 3</b> Standard Analog Input/Output ▼ None ▼	<b>Row 7</b> Standard Analog Input/Output ▼ None ▼
<b>Row 4</b> Standard Analog Input/Output ▼ None ▼	<b>Row 8</b> Standard Analog Input/Output ▼ None ▼

Page 1 2 3 4 5 6 7 8 Apply Close

Figure 19-6. Configuration Screen – Configurable Main Screen Settings (Page 4)

## Section 19 • Configuration

### Analog Outputs

The Vision 20/20 has several Analog outputs for which the operator can choose the use. Once an output is enabled, the Auxiliary I/O screen will be available from the menu screen where the operator can further define the output's operation, see Figure 19-9 and also reference Section 18.

Enable Output #:

- Enables the selected analog output.

Set Name:

- Allows the operator to assign a name to the output.

### Digital Outputs

The Vision 20/20 has several Digital outputs for which the operator can choose the use. Once an output is enabled, the Auxiliary I/O screen will be available from the menu screen where the operator can further define the output's operation, see Figure 19-9 and also reference Section 18.

Enable Output #:

- Enables the selected digital output.

Set Name:

- Allows the operator to assign a name to the output

**Digital Auxiliaries**

**Digital Inputs**

<input checked="" type="checkbox"/> Enable Input #1	Set Name <input type="text" value="Digital Aux in 1"/>	<input type="checkbox"/> Enable Input #5	Set Name <input type="text" value="Digital Aux in 5"/>
<input type="checkbox"/> Enable Input #2	Set Name <input type="text" value="Digital Aux in 2"/>	<input type="checkbox"/> Enable Input #6	Set Name <input type="text" value="Digital Aux in 6"/>
<input type="checkbox"/> Enable Input #3	Set Name <input type="text" value="Digital Aux in 3"/>	<input type="checkbox"/> Enable Input #7	Set Name <input type="text" value="Digital Aux in 7"/>
<input type="checkbox"/> Enable Input #4	Set Name <input type="text" value="Digital Aux in 4"/>	<input type="checkbox"/> Enable Input #8	Set Name <input type="text" value="Digital Aux in 8"/>

Page

Figure 19-7. Configuration Screen - Digital Auxiliaries (Page 5)

## Section 19 • Configuration

### I/O Configuration

If any additional I/O cards are added to the Vission 20/20, this is where these cards are enabled for use by the its algorithms. Some features of the Vission 20/20 will not be available unless specific expansion cards are selected, see Figure 19-10.

#### Digital Output 1:

- Not editable by the operator. Identifies that the Digital Output card 1 is enabled.

#### Digital Output 2:

- Not editable by the operator. Identifies that the Digital Output card 2 is enabled.

#### Digital Input 1:

- Not editable by the operator. Identifies that the Digital Input card 1 is enabled.

#### Digital Input/Output 1:

- Enables the optional digital input/output card 1.

#### Digital Input/Output 2:

- Enables the optional digital input/output card 2.

#### Analog Input 1:

- Not editable by the operator. Identifies that the Analog Input card 1 is enabled.

#### Analog Input 2:

- Not editable by the operator. Identifies that the Analog Input card 2 is enabled.

#### Analog Input 3:

- Enables the optional Analog input card 3.

#### Analog Input 4:

- Enables the optional Analog input card 4.

#### Analog Output:

- Enables the optional Analog Output card.

**Analog Auxiliaries**

**Analog Inputs**

<input type="checkbox"/> Enable Input #1	Set Name <input type="text" value="Analog Aux in 1"/>	<input type="checkbox"/> Enable Input #9	Set Name <input type="text" value="Analog Aux in 9"/>
<input type="checkbox"/> Enable Input #2	Set Name <input type="text" value="Analog Aux in 2"/>	<input type="checkbox"/> Enable Input #10	Set Name <input type="text" value="Analog Aux in 10"/>
<input type="checkbox"/> Enable Input #3	Set Name <input type="text" value="Analog Aux in 3"/>	<input type="checkbox"/> Enable Input #11	Set Name <input type="text" value="Analog Aux in 11"/>
<input type="checkbox"/> Enable Input #4	Set Name <input type="text" value="Analog Aux in 4"/>	<input type="checkbox"/> Enable Input #12	Set Name <input type="text" value="Analog Aux in 12"/>
<input type="checkbox"/> Enable Input #5	Set Name <input type="text" value="Analog Aux in 5"/>	<input type="checkbox"/> Enable Input #13	Set Name <input type="text" value="Analog Aux in 13"/>
<input type="checkbox"/> Enable Input #6	Set Name <input type="text" value="Analog Aux in 6"/>	<input type="checkbox"/> Enable Input #14	Set Name <input type="text" value="Analog Aux in 14"/>
<input type="checkbox"/> Enable Input #7	Set Name <input type="text" value="Analog Aux in 7"/>	<input type="checkbox"/> Enable Input #15	Set Name <input type="text" value="Analog Aux in 15"/>
<input type="checkbox"/> Enable Input #8	Set Name <input type="text" value="Analog Aux in 8"/>	<input type="checkbox"/> Enable Input #16	Set Name <input type="text" value="Analog Aux in 16"/>

Page

Figure 19-8. Configuration Screen - Analog Auxiliaries (Page 6)

## Section 19 • Configuration

**Auxiliary Outputs**

**Analog Outputs**

Enable Output #1    Set Name:

Enable Output #2    Set Name:

Enable Output #3    Set Name:

Enable Output #4    Set Name:

**Digital Outputs**

Enable Output #1    Set Name:

Enable Output #2    Set Name:

Enable Output #3    Set Name:

Enable Output #4    Set Name:

Page:

Figure 19-9. Configuration Screen - Auxiliary Outputs (Page 7)

**I/O Configuration**

Digital Output 1

OPEN			
o	o	o	
			X
4	3	2	1

Analog Input 1

OPEN			
o			o
	X	X	
4	3	2	1

Digital Output 2

OPEN			
o	o	o	o
		X	
4	3	2	1

Analog Input 2

OPEN			
o			
	X	X	X
4	3	2	1

Digital Input 1

OPEN			
o	o		
		X	X
4	3	2	1

Analog Input 3

OPEN			
	o	o	o
X			
4	3	2	1

Digital Input/Output 1

OPEN			
o		o	o
	X		
4	3	2	1

Analog Input 4

OPEN			
	o	o	
X			X
4	3	2	1

Digital Input/Output 2

OPEN			
o		o	
	X		X
4	3	2	1

Analog Output

OPEN			
	o		o
X		X	
4	3	2	1

Page:

Figure 19-10. Configuration Screen - I/O Configuration (Page 8)



## Section 20 • Data Backup

### Overview

The database backup screen provides the operator a way to extract information out of the Vission 20/20 for backup purposes or diagnostics, see Figure 20-1. Through this screen, the operator can download all the Setpoint Databases, Maintenance Logs, Event Lists, Freeze Data, Trend Data and Compressor Run Hours to a portable USB flash drive. That information can then be uploaded back to the Vission 20/20 in the case of data corruption or to update the Vission program. The built-in Migrate function examines the previous setpoint databases, compares them with newer program setpoint database, and moves the old information into the new program. In addition, this screen also allows the operator to reset all values to the factory defaults.

All of the information saved to the USB flash drive is open information, meaning none of it is encrypted and the operator is free to examine it. The log files are all saved as simple ASCII text and the databases can be examined with SQLite.

Refresh:

- The Refresh button is used to initiate a scan of the USB ports and list any devices found in the “Available Devices” window.

### Save / Load

Save / Load section is where the operator can either save the Vission 20/20 setpoints and log information to a USB flash drive or load from a USB flash drive back to the Vission 20/20.

Save:

- Selecting save allows the operator to save the Vission 20/20 data to a USB flash drive using the information provided further down the screen. The bottom button will be labeled “Save” when this is selected.

The screenshot displays the 'Save / Load' interface. At the top, the status bar shows 'Suction Pressure 1', 'Stopped', and '6.3 Psig Δ'. The main 'Save / Load' panel has 'Save' selected. It features an 'Available Devices' list with '/media/usb0' selected, a 'Select Folder/File' list with 'b99.zip', 'b98.zip', and 'b97.zip', and a 'Filename' field containing '/media/usb0/'. Below this are 'Settings' (All selected) and 'Data Items' (Run Hours, Maintenance Logs, Event List, Freeze Data, Trend Data, Setpoints Report). A 'Refresh' button is at the bottom right of the panel. The right-hand control panel includes 'Capacity Slide' (0.0%), 'Volume Slide' (0.0%), and buttons for 'Stop', 'Remote Lock Out', 'Alarm Reset', and 'Unit Start'. The bottom status bar shows 'Maintenance', 'User Access', 'Log off', 'Help', 'Panel 1', 'User: admin', '11/07/2014 14:42:07', 'Run Hours: 0', 'No Scheduled Maintenance', 'No Alarm/Trips Present', and a 'Motor' section with 'Amperage: 0.0 Amps'. The 'Suction Press Control' section shows 'Setpoint: 20.0 Psig'. The 'Suction' section shows 'Press: 26.3 Psig' and 'Temp: 54.8 °F'. The 'Discharge' section shows 'Press: 123.8 Psig' and 'Temp: 71.2 °F'. The 'Discharge : Suction' section shows 'Press Ratio: 3.4'. The 'Oil' section shows 'Press Diff: 46.4 Psig', 'Filter Diff: 9.5 Psig', 'Inj Temp: 114.7 °F', and 'Sep Temp: 110.1 °F'.

Figure 20-1. Data Backup Screen - Save/Load

## Section 20 • Data Backup

---

### Load:

- Selecting Load allows the operator to load data from a USB flash drive to the Vission 20/20 using the information provided further down the screen. The bottom button will be labeled “Load” when this is selected.

### Available Devices:

- This window displays any USB flash drive plugged into one of the Vission 20/20 USB ports. Once one of the available devices is selected, then the drive’s contents will be displayed in the “Select Folder / File” window. If the USB flash drive that is plugged in by the operator is not showing up, then the operator can try pressing the “Refresh” button at the bottom of the screen. Unfortunately, not all USB flash drives are compatible with the Vission 20/20 and will never show up as an available device.

### Select Folder/File:

- This window displays the folders and files contained in the USB flash drive selected in the “Available Devices” window. The information from the Vission 20/20 will be contained into a .zip file. So a zip file will have to be selected to load or overwritten when saved. Once a zip files is selected, the name will be shown in the filename window.

### Unmount:

- By pressing the Unmount button, any USB drive selected in the “Available Devices” window will be disconnected from the operating system and can be safely removed from the USB port.

### Back:

- The back button returns the operator to the preceding window display of files and folders.

### Filename:

- This window is where the operator can give a name to a saved backup file. This field will automatically be populated if a file is selected in the “Select Folder/ File” window.

### Settings:

- Using this table, the operator can choose to save or load all or part of the information contained in the Vission 20/20.

### Data Items:

- Using these checkboxes, the operator can choose to save or load all or part of the information contained in the Vission 20/20 according to the selection of options.

### Save / Load Button:

- This button initiates the save or load process.

## Migrate

Loading data from an older version of the Vision 20/20 software to a newer one can be complicated due to differences in databases. This migrate function closely examines each field in the database being loaded and determines whether it can be used in the new program. The Migrate function is executed automatically when data is loaded from a USB flash drive. The only time an operator should have to use the migrate button is if a new Vision 20/20 program is loaded over an existing Flash card, see Figure 20-2.

Migrate:

- This button initiates the migrate function.

## Factory Reset

The Factory reset button offers the operator the ability to reset all the Vision 20/20 setpoints back to the factory default settings or a specific database. If the operator finds that a screen will not load when selected, it is likely that the database associated with that screen has been corrupted. Unfortunately, data corruption is always a possibility in any system. So this function was designed to help the operator to regain control, see Figure 20-2.

Reset:

- This button initiates the process to revert the Vision 20/20 back to the factory default settings.

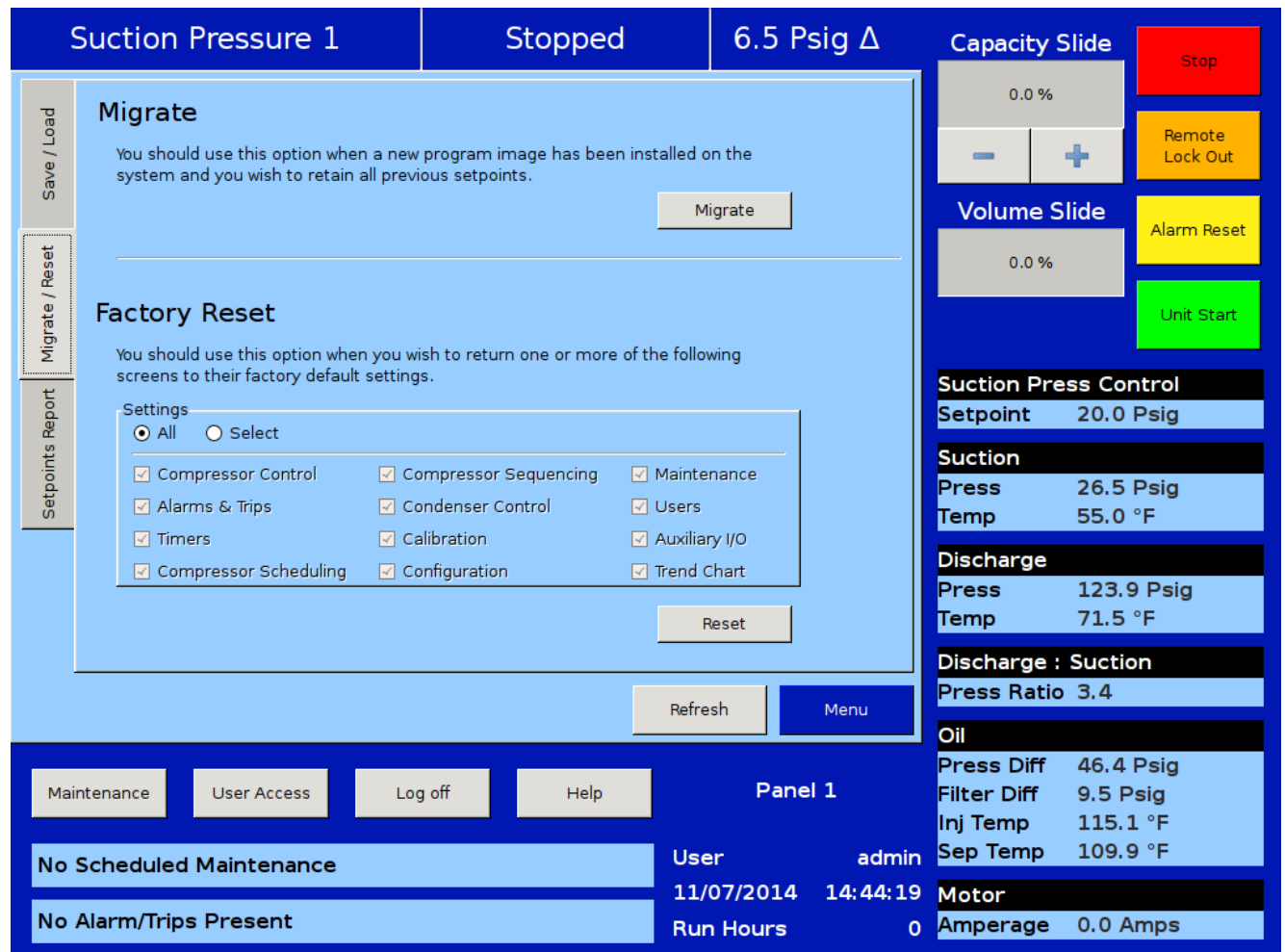

Figure 20-2. Data Backup Screen - Migrate and Factory Reset

## Section 20 • Data Backup

### Setpoints Report

The setpoints report screen offers the operator the ability to generate a setpoints report for all screens. The reports are stored as .csv files and can be saved to a USB drive from Save/Load screen by selecting the Setpoints Report option in Data Items during backup of database. The .csv file can be imported in any spread sheet application. During the course of operation, the operator can generate reports at any time, see Figure 20-3.

All/ Select:

- Selecting “All” will include all screens in the report that is generated. When “Select” is chosen, the operator can choose which screens will be included in the report.

Generate:

- This button initiates the process to generate setpoints report files.

**Suction Pressure 1**      **Stopped**      **6.5 Psig Δ**

**Capacity Slide**      **Stop**  
0.0 %

**Volume Slide**      **Remote Lock Out**  
0.0 %

**Alarm Reset**  
**Unit Start**

**Suction Press Control**  
Setpoint 20.0 Psig

**Suction**  
Press 26.5 Psig  
Temp 55.0 °F

**Discharge**  
Press 124.0 Psig  
Temp 71.2 °F

**Discharge : Suction**  
Press Ratio 3.4

**Oil**  
Press Diff 46.1 Psig  
Filter Diff 9.7 Psig  
Inj Temp 114.9 °F  
Sep Temp 110.3 °F

**Motor**  
Amperage 0.0 Amps

**Setpoints Report**  
You should use this option when you wish to generate setpoints report for one or more of the following screens.

Settings  
 All     Select

Compressor Control     Compressor Sequencing     Auxiliary I/O  
 Alarms & Trips     Condenser Control     Configuration  
 Timers     Calibration     Maintenance  
 Compressor Scheduling     Trend Chart

**Generate**

**Refresh**    **Menu**

Maintenance    User Access    Log off    Help    **Panel 1**

**No Scheduled Maintenance**    User admin  
11/07/2014 14:52:45  
**No Alarm/Trips Present**    Run Hours 0

Figure 20-3. Data Backup Screen - Setpoints Report

### Database Backup Procedure

Upgrading the program in the 20/20 panel normally involves replacing the flashcard. Note that all compressor operation setpoints, calibration values and maintenance information are held on the flashcard. So when upgrading to a new program (new flashcard), the task is simplified by using the “Database Backup” and “Database Restore” functions provided in the 20/20 to migrate the database of the original flashcard to the new flashcard. There are three main steps to this process:

1. Backup the database of original flashcard (currently in the 20/20 panel) – onto a thumbdrive or flashdrive.
2. Replace the original flashcard with new flashcard.
3. Restore the original database to new flashcard.

### BACKUP DATABASE OF ORIGINAL FLASHCARD

#### NOTE

It is REQUIRED to re-enter the Alarms and Trip settings by “hand” when upgrading from some older version of programs, therefore it is highly recommended to create a “hardcopy” of all compressor operating setpoints, or to create and have handy a printout of the Setpoints Report .csv file.

It is also recommended that for documentation purposes, a “hardcopy” of all compressor operation setpoints, configuration information and maintenance information be made prior to changing flashcards. Please reference the “Record operating setpoints and configuration information” section below for a list of all the information that you should record.

The data migration procedure (moving the original flashcard database to new flashcard) uses a “thumbdrive” or “flashdrive” to transfer data from the original flashcard to the new flashcard. Note that there have been a few reports of some thumbdrives not being recognized by the 20/20. If you have difficulty in getting the 20/20 to recognize the thumbdrive – then try a different one. Vilter™ have successfully tested a number of different manufacturers and sizes; a partial list is below;

- SanDisk micro cruiser 2.0GB
- Imation 2.0GB
- Kingston DataTraveler 512MB
- SanDisk mini cruiser 128MB
- AirBus 32MB

1. With the original flashcard installed into the 20/20 SBC, insert the flashdrive into the USB port. This port is located along the right side of the single board computer below the flashcard. (Please reference the picture in the section titled; Flashcard Replacement Procedure Hardcopy
2. Logon using the your username and password (you will need to be to be Level 3 to upload data).
3. Navigate to the Data Backup screen.
4. Under “Available Devices” – you should see something like “/media/usb0” . If you don’t see anything in this box, press the “Refresh” button, wait about 5 seconds and then press it again.. If you still don’t see it, then the 20/20 does not recognize the flashdrive – try a different one. If you do see it, highlight it.
5. Now highlight the “Filename” box (which will also contain “/media/usb0”). A keyboard will appear – now type in the name of the file that you want for your database for this compressor.... For instance... “vss03\_month\_day\_year” or something similar to identify the file to the compressor – then press “Enter” key on keyboard.
6. Now press the SAVE button. A “watch” icon will appear. Shortly thereafter, a popup box should appear – telling you that the save was successful, and asking if you want to “unmount” the flashdrive device. Press YES. If the “watch” icon doesn’t go away after a minute or so, then the 20/20 isn’t able to close the backup file it has written to the thumbdrive. Power down the 20/20 and try the procedure with a different thumbdrive.

### REPLACE ORIGINAL FLASHCARD WITH NEW FLASHCARD

Now that the database file has been saved to the thumbdrive – the “original” flashcard can be replaced with the new flashcard.

1. Power the 20/20 down, remove the thumbdrive and take out the “original” flashcard and install the new one.
2. Label both the old and new card to identify the compressor it is for.

### RESTORE ORIGINAL DATABASE TO NEW FLASHCARD

Now that the new card is inserted, power the 20/20 panel back up. As the 20/20 boots up, a message may appear indicating that an “incompatibility” has been found. This is NORMAL. The new flashcards are built such that they

## Section 20 • Data Backup

---

recognize a couple of different single board computers. Upon boot up – the cards are automatically configured for the correct single board computer that is identified. After seeing this message, it will take a minute or so before the 20/20 boots up properly.

1. Once the 20/20 panel is booted back up, Press the “USER ACCESS” button – which is the new wording for the Logon button. Logon. Now insert the thumbdrive back into the USB port.
2. Navigate to the Data Backup screen. You should again see the USB thumbdrive listed under the “Available Devices.”
3. Select the LOAD function (above the “Available Devices” field), and then highlight the device that is listed in the “Available Devices” window.
4. To the right of the “Available Devices” – there is a “Select Folder/File” window. In this window, find the backup file for this compressor, and highlight it. Now press the “Load” button.
  - a. A pop-up window will appear – saying “Loading new databases will require a program restart. Continue?”. Press YES.
  - b. Another pop-up window may appear... stating something like “One or more settings selected for loading were missing from the archive.... And it will then list what is missing. Continue loading anyway? Press “Yes”.
5. Another pop-up box may appear – asking if you want to use the IP address it found. Press “OK”
6. A pop-up box will appear saying “Settings were successfully loaded. Program will restart.” Press OK button.

When the OK button is pressed, the panel will reboot.

Now – using the “hand documented” settings that you recorded, compare the setpoints on that list against

those in the 20/20. They should all be OK. Here are the KNOWN issues that we have found with this procedure.

- The Alarm and Trip setpoints MAY need to be re-entered. Early version programs actually saved two Alarm and Trip setpoints tables onto the old flash-card, and when saving the tables to the thumbdrive during the Database backup procedure, the old program backed up the wrong table to the thumbdrive. When a database “restore” (load) procedure is done with the new program, the new program recognizes that the Alarm and Trip tables are not correct, and refuses to restore them. In this case, you’d need to re-enter your Alarm and Trip setpoints manually.
- If you have any setpoint (including Alarms and Trips and Control settings) that is in “ inches of vacuum” – that value will be restored as a “positive PSIG” setpoint. That is a known bug of the “Restore” function. So, for instance, say you have the Suction Pressure Trip setpoint set at 3.1“hg. When the value is restored, it will be restored as + 3.1 PSIG. You’ll need to re-enter this setpoint as minus 1.5 psig (which correlates to 3.1 inches of Hg.). Do this for any setpoint that was originally set as “inches of Hg.”
- If you have communication connection issues after restoring the database, you may have to “re-enter” the IP address that is shown on page 1 of the configuration screen. If you experience communication problems after the “Restore” function – then re-enter you communication settings.
- Navigate to the Maintenance screen and look at the “Time Remaining” column – comparing that calculation against the “Maintenance Interval Hours” and the actual runtime of the compressor. If the calculation isn’t correct, then do the following;
  - Navigate to the Configuration screen – page 1 and re-enter the compressor “run hours” – located along the top right of the screen.
  - Once you do that, then press the “APPLY” button, wait about 10 or 15 seconds. Then cycle power on the panel. This will force the Maintenance “Time Remaining” column to be properly calculated.

## Section 20 • Data Backup

---

### RECORD OPERATING SETPOINTS AND CONFIGURATION INFORMATION

Before powering down to replace the flashcard, copy down all of the following operating setpoints and configuration information.

1. Configuration Screen - Page 1
  - a. Order number
  - b. Active Remote Control Setting
  - c. If Active Remote Control = Direct I/O, document “type” of Direct I/O selection.
  - d. Ethernet IP settings
  - e. Anti-Recycle Settings
2. Configuration Screen - Page 2
  - a. Compressor Type, Model, Refrigerant
  - b. Compressor Control Type & number of Controllers
  - c. Oil Pump selection
  - d. Oil Cooling type
  - e. Motor Current Device
  - f. Optional Function Selections
3. Configuration Screen - Page 6
  - a. Optional I/O boards
4. Compressor Control Setpoints – all
5. Alarms and Trips Setpoints – all
6. Timer Setpoints – all
7. Instrument Calibration - Pressure page
  - a. Record Transducer Range selection for suction pressure, discharge pressure, filter inlet pressure, oil manifold pressure.
  - b. Record ‘total offset’ value for suction pressure, discharge pressure, filter inlet pressure, oil manifold pressure
8. Instrument Calibration - Temperature page
  - a. Record ‘total offset’ for suction temperature, discharge temperature, oil separator temperature, oil manifold temperature and process temperature.

9. Instrument Calibration - Analog Inputs page
  - a. Record current transformer ratio
10. Maintenance Notes –all
11. Compressor Runtime.

### REPLACE FLASHCARD

(Refer to Figure 20-4)

1. Remove power from Vission 20/20 panel.
2. Remove old flashcard and install new flashcard and power panel back up.

### RE-ENTER OPERATING SETPOINTS AND CONFIGURATION INFORMATION

1. Log on as “admin” user (default password = admin).
2. Re-enter all values in Configuration screen. The most vital thing is to re-enter the correct compressor type, model and refrigerant. Re-enter the Compressor Runtime on page 1 of the configuration screen. Make sure you re-select any optional boards that are installed, and apply those additions.
3. Re-enter all Control Limits
4. Re-enter all Alarm and Trip setpoints. The most vital thing is - under the “Delay” tab, enter 5 seconds for all alarm and trip delays.
5. Re-enter all Timer Setpoints
6. Re-enter all Instrument Calibration offsets for pressure transducers. Insure that the Suction Pressure transducer range is properly selected (typically 0-200psia 4-20ma) – but double check proper setting. In the Analo page – re-enter C/T Ratio.
7. Re-enter Maintenance Notes if desired.
8. You do not need to recalibrate the capacity and volume actuators.



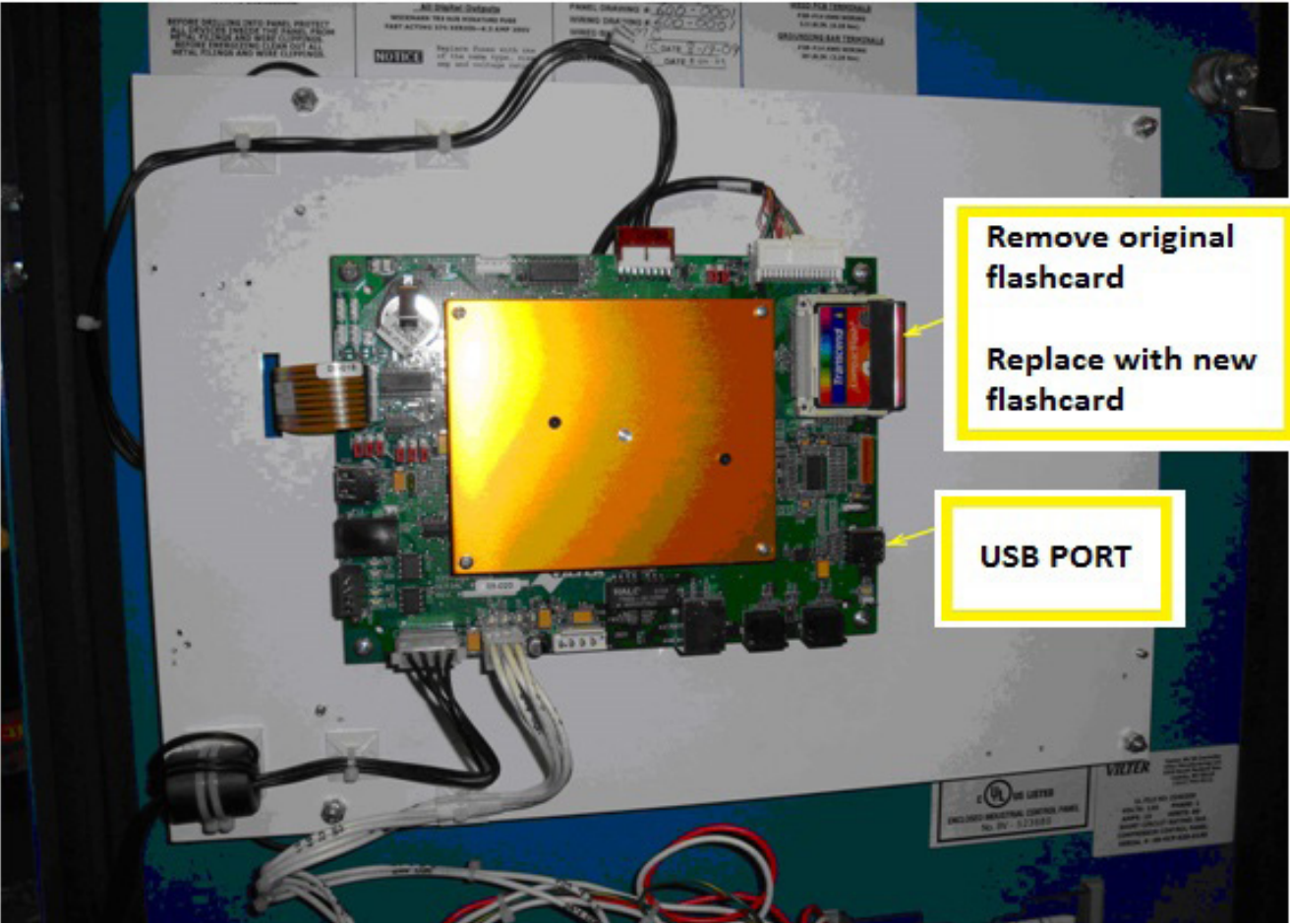

Figure 20-4. Flashcard Replacement



## Section 21 • Maintenance

### Overview

The maintenance screen is a convenient place to keep track of the maintenance performed and any up-coming maintenance recommended by Vilter™. Based on this page, banners will be displayed on the lower status bar. Yellow banners are to warn the operator of any up-coming maintenance and red banners indicate maintenance that is overdue.

### Chart

This chart is the original maintenance chart that is provided with the compressor; see Figure 21- 1. The maintenance chart contains the list of maintenance items and their respective service intervals. The operator will also perform maintenance sign-off in the maintenance chart. Once the operator has decided the item to sign off, pressing the service interval item will perform the

sign-off operation and list the maintenance performed in the maintenance log.

Maintenance Item:

- This column lists down the all maintenance Items.

Maintenance Notes Icon:

- By pressing the notes icon, a pop-up with Notes will get displayed for maintenance Item. Refer to Figure 21- 3.

Service Interval (Hours):

- This indicates the intervals at which the maintenance should be performed.
- When maintenance is up-coming, the service interval field is highlighted with a yellow background. Refer to Figure 21- 4.

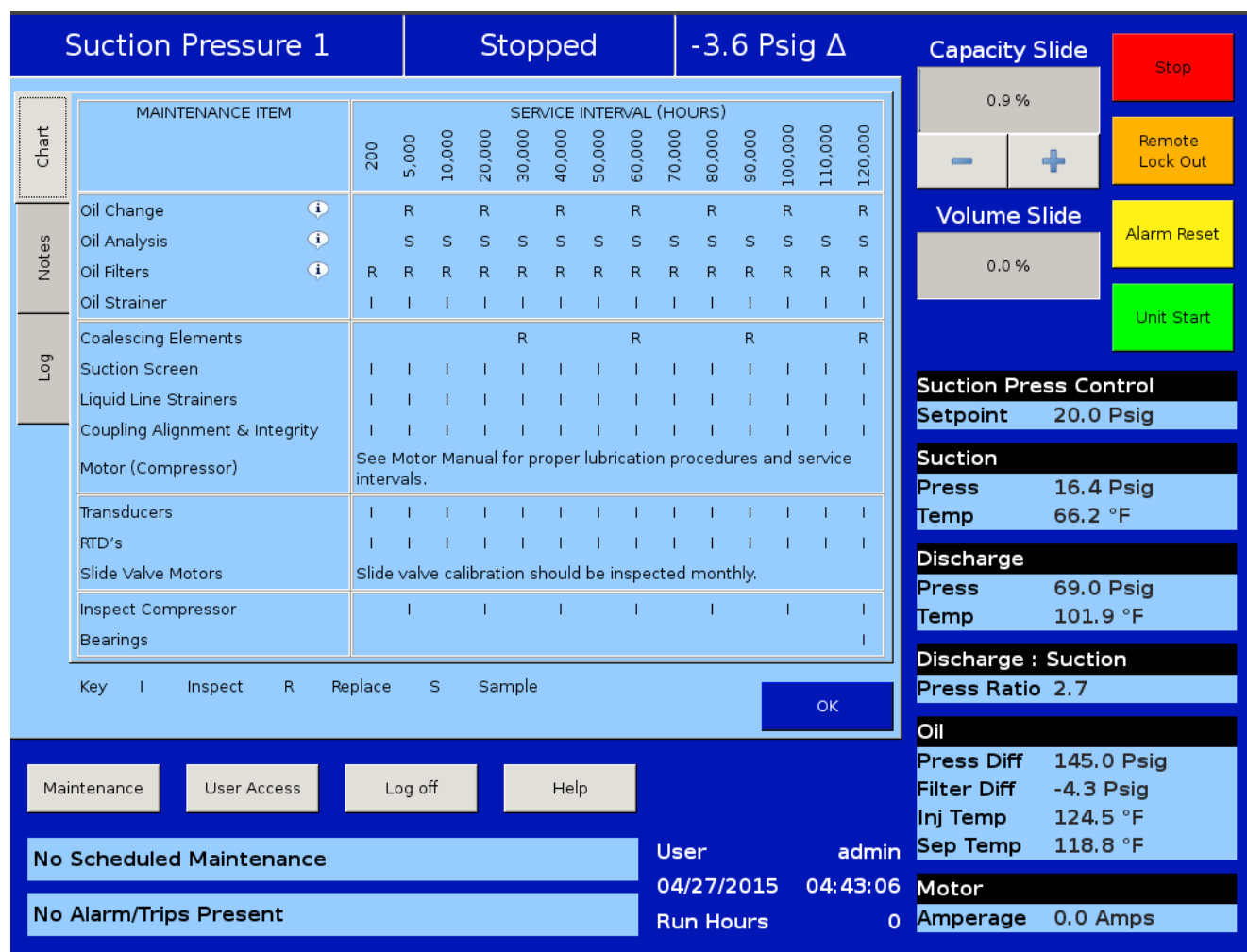

Figure 21-1. Maintenance Screen - Chart

## Section 21 • Maintenance

Suction Pressure 1
Stopped
-4.0 Psig Δ

MAINTENANCE ITEM	SERVICE INTERVAL														
	200	5,000	10,000	15,000	20,000	25,000	30,000	35,000	40,000	45,000	50,000	55,000	60,000	65,000	70,000
Oil Change	R	R	R	R	R	R	R	R	R	R	R	R	R	R	R
Oil Analysis	S	S	S	S	S	S	S	S	S	S	S	S	S	S	S
Oil Filters	R	R	R	R	R	R	R	R	R	R	R	R	R	R	R
Oil Strainers	I	I	I	I	I	I	I	I	I	I	I	I	I	I	I
Coalescing Filter			R			R			R			R			
Coalescing Drain Line	I	I	I	I	I	I	I	I	I	I	I	I	I	I	I
Suction Screen	I	I	I	I	I	I	I	I	I	I	I	I	I	I	I
Coupling Alignment & Integrity	I	I	I	I	I	I	I	I	I	I	I	I	I	I	I
Motor (Compressor)	See Motor Manual for proper lubrication procedures and service inte														
Transducers	I	I	I	I	I	I	I	I	I	I	I	I	I	I	I
RTD's	I	I	I	I	I	I	I	I	I	I	I	I	I	I	I
Slide Valve Motors	Slide valve calibration should be inspected monthly. Inspections can Movement Alarm appears, calibrate immediately.														
Inspect Compressor															

Capacity Slide

0.9 %

- | +

Remote Lock Out

Volume Slide

0.0 %

Alarm Reset

Unit Start

**Suction Press Control**

Setpoint 20.0 Psig

**Suction**

Press 16.0 Psig

Temp 67.8 °F

**Discharge**

Press 68.8 Psig

Temp 101.9 °F

**Discharge : Suction**

Press Ratio 2.7

**Oil**

Press Diff 145.3 Psig

Filter Diff -4.2 Psig

Inj Temp 125.9 °F

Sep Temp 120.6 °F

**Motor**

Amperage 0.0 Amps

Key I Inspect R Replace S Sample

OK

Maintenance

User Access

Log off

Help

No Scheduled Maintenance

No Alarm/Trips Present

User admin

04/27/2015 04:30:07

Run Hours 0

Figure 21-2. Maintenance Screen - Chart for Heat Pump

- When maintenance is overdue, service interval field is highlighted in red background. Refer to Figure 21-5.
- When maintenance is up-coming or already overdue, the operator can sign-off on a maintenance item by pressing on the service interval field, and a confirmation popup will get displayed. Refer to Figure 21- 6.
- On performing the sign-off operation, the service interval field will be highlighted with a green background and the Maintenance Log will get updated. Refer to Figure 21- 7 & Figure 21- 9.

# Section 21 • Maintenance

Suction Pressure 1
Stopped
-4.0 Psig Δ

Chart	MAINTENANCE ITEM	SERVICE INTERVAL (HOURS)												
		200	5,000	10,000	20,000	30,000	40,000	50,000	60,000	70,000	80,000	90,000	100,000	110,000
Notes	Oil Change	R	R	R	R	R	R	R	R	R	R	R	R	R
	Oil Analysis	S	S	S	S	S	S	S	S	S	S	S	S	S
	Oil Filters	R	R	R	R	R	R	R	R	R	R	R	R	R
	Oil Strainer	I	I	I	I	I	I	I	I	I	I	I	I	I
Log	Coalescing Elements				R			R				R		R
	Suction Screen													
	Liquid Line Strainers													
	Coupling Alignment & Integrity													
	Motor (Compressor)													
	Transducers													
	RTD's													
	Slide Valve Motors													
	Inspect Compressor													
	Bearings													

The oil should be changed at these intervals, unless oil analysis results exceed the allowable limits. The frequency of changes will depend on the system cleanliness.

Key   I   Inspect   R   Replace   S   Sample

Capacity Slide

0.9 %

-   +

Volume Slide

0.0 %

**Suction Press Control**

Setpoint   20.0 Psig

**Suction**

Press   16.0 Psig

Temp   67.1 °F

**Discharge**

Press   68.9 Psig

Temp   102.3 °F

**Discharge : Suction**

Press Ratio   2.7

**Oil**

Press Diff   145.6 Psig

Filter Diff   -5.0 Psig

Inj Temp   124.7 °F

Sep Temp   119.5 °F

**Motor**

Amperage   0.0 Amps

Maintenance   User Access   Log off   Help

**No Scheduled Maintenance**

**No Alarm/Trips Present**

User   admin

04/27/2015   04:43:27

Run Hours   0

Figure 21-3. Maintenance Screen - Notes Icon

# Section 21 • Maintenance

**Suction Pressure 1**

**Stopped**

**-4.0 Psig Δ**

Chart	MAINTENANCE ITEM	SERVICE INTERVAL (HOURS)														
		200	5,000	10,000	20,000	30,000	40,000	50,000	60,000	70,000	80,000	90,000	100,000	110,000	120,000	
Notes	Oil Change	R	R	R	R	R	R	R	R	R	R	R	R	R	R	
	Oil Analysis	S	S	S	S	S	S	S	S	S	S	S	S	S	S	
	Oil Filters	R	R	R	R	R	R	R	R	R	R	R	R	R	R	
	Oil Strainer	I	I	I	I	I	I	I	I	I	I	I	I	I	I	
Log	Coalescing Elements					R			R			R			R	
	Suction Screen	I	I	I	I	I	I	I	I	I	I	I	I	I	I	
	Liquid Line Strainers	I	I	I	I	I	I	I	I	I	I	I	I	I	I	
	Coupling Alignment & Integrity	I	I	I	I	I	I	I	I	I	I	I	I	I	I	
	Motor (Compressor)	See Motor Manual for proper lubrication procedures and service intervals.														
	Transducers	I	I	I	I	I	I	I	I	I	I	I	I	I	I	
	RTD's	I	I	I	I	I	I	I	I	I	I	I	I	I	I	
	Slide Valve Motors	Slide valve calibration should be inspected monthly.														
	Inspect Compressor Bearings															

Key I Inspect R Replace S Sample OK

Maintenance User Access Log off Help

**Maintenance Required in 1 hours**

**No Alarm/Trips Present**

User: admin

04/27/2015 04:40:08

Run Hours: 199

**Capacity Slide**

0.9 %

[-] [+]

**Volume Slide**

0.0 %

[-] [+]

Stop

Remote Lock Out

Alarm Reset

Unit Start

**Suction Press Control**

Setpoint 20.0 Psig

**Suction**

Press 16.0 Psig

Temp 65.1 °F

**Discharge**

Press 68.4 Psig

Temp 101.2 °F

**Discharge : Suction**

Press Ratio 2.7

**Oil**

Press Diff 144.6 Psig

Filter Diff -4.7 Psig

Inj Temp 124.9 °F

Sep Temp 119.5 °F

**Motor**

Amperage 0.0 Amps

Figure 21-4. Maintenance Screen - Maintenance Due Soon

# Section 21 • Maintenance

Suction Pressure 1
Stopped
-3.4 Psig Δ

	MAINTENANCE ITEM	SERVICE INTERVAL (HOURS)													
		200	5,000	10,000	20,000	30,000	40,000	50,000	60,000	70,000	80,000	90,000	100,000	110,000	120,000
Chart															
Notes	Oil Change	R	R	R	R	R	R	R	R	R	R	R	R	R	R
	Oil Analysis	S	S	S	S	S	S	S	S	S	S	S	S	S	S
	Oil Filters	R	R	R	R	R	R	R	R	R	R	R	R	R	R
	Oil Strainer	I	I	I	I	I	I	I	I	I	I	I	I	I	I
Log	Coalescing Elements				R			R				R			R
	Suction Screen	I	I	I	I	I	I	I	I	I	I	I	I	I	I
	Liquid Line Strainers	I	I	I	I	I	I	I	I	I	I	I	I	I	I
	Coupling Alignment & Integrity	I	I	I	I	I	I	I	I	I	I	I	I	I	I
	Motor (Compressor)	See Motor Manual for proper lubrication procedures and service intervals.													
	Transducers	I	I	I	I	I	I	I	I	I	I	I	I	I	I
	RTD's	I	I	I	I	I	I	I	I	I	I	I	I	I	I
	Slide Valve Motors	Slide valve calibration should be inspected monthly.													
	Inspect Compressor		I	I	I	I	I	I	I	I	I	I	I	I	I
	Bearings														

Key I Inspect R Replace S Sample

OK

Maintenance User Access Log off Help

**Maintenance Items Are Overdue**

**No Alarm/Trips Present**

User admin

04/27/2015 04:40:53

Run Hours 200

Capacity Slide 0.9 % Stop

Volume Slide 0.0 % Remote Lock Out

Alarm Reset

Unit Start

**Suction Press Control**

Setpoint 20.0 Psig

---

**Suction**

Press 16.6 Psig

Temp 67.8 °F

---

**Discharge**

Press 68.8 Psig

Temp 102.3 °F

---

**Discharge : Suction**

Press Ratio 2.7

---

**Oil**

Press Diff 144.8 Psig

Filter Diff -4.6 Psig

Inj Temp 125.4 °F

Sep Temp 120.4 °F

---

**Motor**

Amperage 0.0 Amps

Figure 21-5. Maintenance Screen - Maintenance Overdue

# Section 21 • Maintenance

**Suction Pressure 1**

**Stopped**

**-3.6 Psig Δ**

**Capacity Slide**

0.9 %

[-] [+]

**Remote Lock Out**

**Stop**

**Volume Slide**

0.0 %

[-] [+]

**Alarm Reset**

**Unit Start**

MAINTENANCE ITEM	SERVICE INTERVAL (HOURS)													
	200	5,000	10,000	20,000	30,000	40,000	50,000	60,000	70,000	80,000	90,000	100,000	110,000	120,000
Oil Change	R	R	R	R	R	R	R	R	R	R	R	R	R	R
Oil Analysis	S	S	S	S	S	S	S	S	S	S	S	S	S	S
Oil Filters	R	R	R	R	R	R	R	R	R	R	R	R	R	R
Oil Strainer	I	I	I	I	I	I	I	I	I	I	I	I	I	I
Coalescing Elements					R			R				R		R
Suction Screen	I	I	I	I	I	I	I	I	I	I	I	I	I	I
Liquid Line Strainers	I	I	I	I	I	I	I	I	I	I	I	I	I	I
Coupling Alignment & Integrity	I	I	I	I	I	I	I	I	I	I	I	I	I	I
Motor (Compressor)	See inter													
Transducers	I	I	I	I	I	I	I	I	I	I	I	I	I	I
RTD's	I	I	I	I	I	I	I	I	I	I	I	I	I	I
Slide Valve Motors	Slide													
Inspect Compressor	I	I	I	I	I	I	I	I	I	I	I	I	I	I
Bearings	I	I	I	I	I	I	I	I	I	I	I	I	I	I

Key I Inspect R Replace S Sample

**OK**

Maintenance

User Access

Log off

Help

**Maintenance Items Are Overdue**

No Alarm/Trips Present

User admin

04/27/2015 04:41:21

Run Hours 200

**Suction Press Control**

Setpoint 20.0 Psig

**Suction**

Press 16.4 Psig

Temp 67.6 °F

**Discharge**

Press 68.9 Psig

Temp 102.5 °F

**Discharge : Suction**

Press Ratio 2.7

**Oil**

Press Diff 144.6 Psig

Filter Diff -4.3 Psig

Inj Temp 125.4 °F

Sep Temp 120.1 °F

**Motor**

Amperage 0.0 Amps

Figure 21-6. Maintenance Screen - Confirmation for Maintenance Sign-Off

# Section 21 • Maintenance

Suction Pressure 1
Stopped
-3.6 Psig Δ

	MAINTENANCE ITEM	SERVICE INTERVAL (HOURS)													
		200	5,000	10,000	20,000	30,000	40,000	50,000	60,000	70,000	80,000	90,000	100,000	110,000	120,000
Chart															
Notes	Oil Change	R	R	R	R	R	R	R	R	R	R	R	R	R	R
	Oil Analysis	S	S	S	S	S	S	S	S	S	S	S	S	S	S
	Oil Filters	R	R	R	R	R	R	R	R	R	R	R	R	R	R
	Oil Strainer	I	I	I	I	I	I	I	I	I	I	I	I	I	I
Log	Coalescing Elements				R			R				R			R
	Suction Screen	I	I	I	I	I	I	I	I	I	I	I	I	I	I
	Liquid Line Strainers	I	I	I	I	I	I	I	I	I	I	I	I	I	I
	Coupling Alignment & Integrity	I	I	I	I	I	I	I	I	I	I	I	I	I	I
	Motor (Compressor)	See Motor Manual for proper lubrication procedures and service intervals.													
	Transducers	I	I	I	I	I	I	I	I	I	I	I	I	I	I
	RTD's	I	I	I	I	I	I	I	I	I	I	I	I	I	I
	Slide Valve Motors	Slide valve calibration should be inspected monthly.													
	Inspect Compressor		I	I	I	I	I	I	I	I	I	I	I	I	I
	Bearings														

Key   I   Inspect   R   Replace   S   Sample

Capacity Slide

0.9 %

-   +

Volume Slide

0.0 %

-   +

Suction Press Control

Setpoint   20.0 Psig

Suction

Press   16.4 Psig

Temp   67.1 °F

Discharge

Press   69.0 Psig

Temp   102.1 °F

Discharge : Suction

Press Ratio   2.7

Oil

Press Diff   145.2 Psig

Filter Diff   -4.7 Psig

Inj Temp   125.4 °F

Sep Temp   120.4 °F

Motor

Amperage   0.0 Amps

Maintenance   User Access   Log off   Help

User   admin

04/27/2015   04:39:22

Run Hours   200

Stop

Remote Lock Out

Alarm Reset

Unit Start

No Scheduled Maintenance

No Alarm/Trips Present

OK

Figure 21-7. Maintenance Screen - Maintenance Sign-Off

## Section 21 • Maintenance

Suction Pressure 1      Stopped      -4.3 Psig Δ

Maintenance Screen

Chart  
Notes  
Log

Capacity Slide  
1.0 %  
-    +  
Remote Lock Out

Volume Slide  
0.0 %  
Alarm Reset  
Unit Start

Suction Press Control  
Setpoint 20.0 Psig

Suction  
Press 15.7 Psig  
Temp 67.1 °F

Discharge  
Press 69.0 Psig  
Temp 101.9 °F

Discharge : Suction  
Press Ratio 2.8

Oil  
Press Diff 145.7 Psig  
Filter Diff -4.2 Psig  
Inj Temp 124.7 °F  
Sep Temp 119.9 °F

Motor  
Amperage 0.0 Amps

Clear    OK

Maintenance    User Access    Log off    Help

No Scheduled Maintenance    User admin  
04/27/2015 05:55:27

No Alarm/Trips Present    Run Hours 0

Figure 21-8. Maintenance Screen - Notes

### Notes:

- The notes tab allows the operator to make notes for any other personnel that might have access to the Vision 20/20. Refer to Figure 21- 8.



## Section 21 • Maintenance

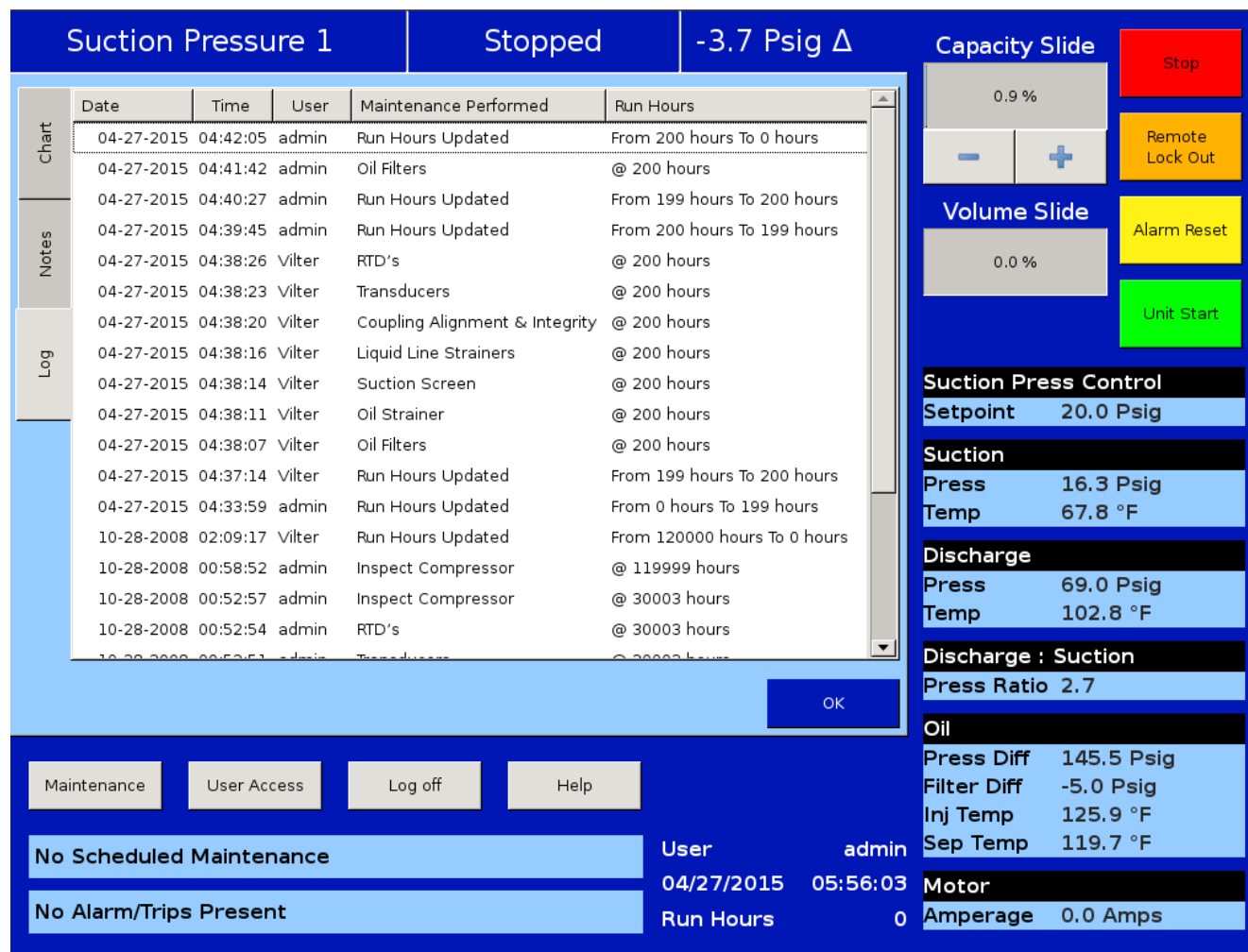

Figure 21-9. Maintenance Screen - Log

### Log:

- The maintenance log tab lists all the maintenance tasks performed in descending order, see Figure 21-8.

### Date:

- Lists the date the maintenance task was performed.

### Time:

- Lists the time the maintenance task was performed.

### User:

- Lists the name of the operator who performed the maintenance task.

### Maintenance Performed:

- Lists the maintenance tasks that were performed.

### Run Hours:

- Lists the run hours at which the maintenance task was performed.

## Section 22 • User Access

### Overview

The user access screen is where all operators go to log in. In the Vision 20/20, each screen has a security level, giving operators, technicians and/or supervisors the ability to modify different sets of setpoints. The Vision 20/20 has four levels of security, see Figure 22-1.

- Level 0 – This is the default level with no operator logged in. The functions available to the operator are very limited and basically only allows someone to start and stop the compressor.
- Level 1 – This is a technician level of access. All the setpoints needed to operate and adjust the performance of the compressor will be available to an operator with this level of access.
- Level 2 – This is a supervisor level of access. Setpoints that require a higher level of knowledge such as calibrating instrument will be available to an operator with this level of access.

- Level 3 – This is considered a contractor level of access. The setpoints available at this level have the most potential of causing damage to the compressor. Therefore, this access is restricted to those only with the highest level of competence.

The user access screen is also where new operators are added, changed or removed. Any operator can add an additional operator but can only add an operator of lesser or equal security level.

The 20/20 will be shipped with a Level 3 operator and password pre-assigned to the installing contractor. He can then assign all users with security levels as needed.

The procedure to assign user access levels is to first press the User Access button. The User Access screen will appear with the preassigned level 3 operator name visible within the Operators section. Highlight the name, then enter the password associated with that name of the user, then press Enter key to close the keyboard. Then press the “Apply” button. Press the “Manage Accounts” tab to begin the process of entering another Operator

Figure 22-1. User Access Screen - Login

## Section 22 • User Access

name, and assigning password and user level of this additional user. Lastly – remember to press the Add/Update button to add this user to the list, then press the “Apply” button before exiting the “User access” screen to make this change permanent.

### Login

The login tab is where an operator will enter the user’s name and password in order to gain access to the Vision 20/20 screens. If the User name and password matches an existing user then the operators name will be applied to the lower status bar and the operator will be given access to screens of equal security level.

Operators:

- All operators that have been added to the Vision 20/20 user tables will be displayed in this window. If a name of an operator is selected from this window, the name is added to the “Operator Name” entry box.

Operator Name:

- This entry box is for the operator’s username. The operator can either select the username from the operators window or enter the username manually by touching the entry box and entering the name via the pop-up keyboard.

Operator Password:

- This entry box is for the operator’s password. The password can be entered by touching the password entry box and entering the password via the pop-up keyboard.

### Manage Accounts

This tab allows the addition, removal, and modification of authorized users, see Figure 22-2.

Operators:

- This window contains the list of authorized users already added to the Vision 20/20. Selecting a name

Figure 22-2. User Access Screen - Manage Accounts

## Section 22 • User Access

from this list will add that name to the “Operator Name” entry box.

Operator Name:

- This entry box is for the operator’s username who is to be added, removed or modified. The operator can either select the username from the operators window or enter the username manually by touching the entry box and entering the name via the pop-up keyboard.

Operator Password:

- This entry box is for the operator’s password. The password can be entered by touching the password entry box and entering the password via the pop-up keyboard.

Verify Password:

- This entry box is to verify the operator’s password. Verifying the password can be entered by touching the “Verify Password” entry box and entering the password via the pop-up keyboard.

Security Level:

- Select a security level for the account being added or modified. Only levels that are equal to or less than the operator’s own security level will be shown.

Add / Update:

- Pressing this button will initiate the creation or modification of the specified account.

Delete:

- Pressing this button will delete the specified account.

### Screen Security Levels

The following table lists all screen and their base security levels, see Table 22-1. The majority of the screens have more than one security level. The base security level gives the user access to the setpoints that can change to performance of the compressor. The secondary security level is typically level 3 and is reserved for those setpoints that require great care and knowledge of the system in order to change safely.

**Table 22-1. Security Access Levels**

Security Access Levels		
Page	User Level	* Note
Event List	Level 0	View
Input/Output States	Level 0	View/create freeze screen
Trend Chart	Level 0	View/operate
Help	Level 0	-
Alarms & Trips	Level 1*	Level 3 required for constraints
Compressor Scheduling	Level 1	-
Compressor Sequencing	Level 1	Setpoints can be modified / set at Level 1
Condenser Control	Level 1*	Level 3 required for constraints Setpoints can be modified / set at Level 1
Compressor Control	Level 1*	Level 3 required for constraints
Maintenance	Level 1	-
Data Backup	Level 1*	Level 3 required to upload data
Instrument Calibration	Level 2	-
Service Option	Level 2	-
Configuration	Level 2*	Level 3 required for pages 3 - 6
Slide Calibration	Level 2	-
Set Language	Level 2	
Timers	Level 2*	Level 3 required for constraints
Moving Volume Slide	Level 3	
VNC Account	Level 3	-

## Section 23 • Help Screen

### Overview

Use this screen to receive help on other setpoint screens contained within the software. These help files can be accessed from any screen. The help files describe the functionality of that screen as well as compressor operation.

### Screen Features

Manual Tab:

- Contains the list of available manual sections to be displayed in the display window, see Figure 23-1.

USB tab:

- The operator has the option to view other manuals, typically Vilter™ compressor manuals on the Vision 20/20 from a USB drive, see Figure 23-2. If there are any PDF type documents on a connected USB drive, the names will be listed in this section. The operator

will have to navigate through the file structure of the USB drive to find the documents. The top box in the USB drive will display any USB drives mounted to the Vision 20/20 OS.

- Touching one of the listed USB devices will select that device and list any files or PDF documents contained on the USB drive. Selecting a folder will open that folder and display any sub-folders of PDF documents.

Unmount:

- Pressing the unmount button will disconnect the USB drive from the Vision 20/20 operating system. Once the device has been removed from the device list, the USB drive can be safely removed.

Refresh:

- Pressing this button will reread the USB ports and display any new USB drives.

**Suction Pressure 1** | **Stopped** | **1.9 Psig Δ**

Manual | USB

Menu Screen  
Main Screen  
Maintenance  
Remote Oil Cooler  
Slide Calibration  
User Access  
Event List  
Twin Screw Control  
Operational Flow Char  
Input/Output  
Service Options  
Configuration  
Compressor Sequenc  
Installation Recomme  
Compressor Control  
Trend Chart  
Timers  
Alarms and Trips  
Auxiliary I/O

**Section 6 • Compressor Control**

**Overview**

The compressor control screen is where an operator can set the majority of the compressor settings. These settings define how the compressor will operate and respond to changing loads. The compressor control screen consists of several screens but in order not to overwhelm the operator with options, many of the screens may not be visible.

**NOTE**

How the compressor is configured in the configuration screen (Section 19) will determine what compressor control pages are displayed. Additional setup information can be found in Appendix B.

It is important to note that there is not one correct way to set these parameters. Every application is different and requires the operator to tune these settings to achieve the best operation.

**Suction Pressure Control and Process Temperature Control**

The Vision 20/20 uses a pulse proportional control method to control the compressor capacity slide valve in order to maintain the control setpoint. The control setpoint can either be process temperature control setpoint or suction pressure control setpoint depending on what the operator has selected as the control mode. For screens, see Figure 6-1, Figure 6-2 and Figure 6-4.

The proportion control uses the Interval Time Setpoint to define the time the algorithm waits to read the current setpoint and calculates the error from the process control setpoint. Based on the error from setpoint, the algorithm calculates a pulse time in which the capacity slide is moved in the direction of the error. The further away the process variable is from the control setpoint, the larger the corrective pulse will be. The duration of the pulse is limited by the Pulse Time Setpoint. By default the maximum pulse time is the same as the interval time. This means that the pulse time can be 100% of

**Suction Pressure Control**

Setpoint 1	Setpoint 2
Pressure Control Setpoint: 20.0 Psig	20.0 Psig
Capacity Increase Interval / Pulse Time: 4.0 sec / 4.0 sec	4.0 sec / 4.0 sec
Proportional / Dead Band: 4.0 Psig / 10.0 %	4.0 Psig / 10.0 %
Capacity Decrease Interval / Pulse Time: 4.0 sec / 4.0 sec	4.0 sec / 4.0 sec
Proportional / Dead Band: 4.0 Psig / 10.0 %	4.0 Psig / 10.0 %

Auto-cycle  Enable

**Capacity Slide**  
0.2 %  
- +  
Remote Lock Out

**Volume Slide**  
0.0 %  
Alarm Reset  
Unit Start

**Suction Press Control**  
Setpoint 20.0 Psig

**Suction**  
Press 21.9 Psig  
Temp 41.8 °F

**Discharge**  
Press 130.6 Psig  
Temp 130.2 °F

**Discharge : Suction**  
Press Ratio 4.0

**Oil**  
Press Diff 148.7 Psig  
Filter Diff 10.2 Psig  
Inj Temp 116.0 °F  
Sep Temp 119.0 °F

**Motor**  
Amperage 0.0 Amps

Fullscreen | Page 1 | Previous | Next | Version | OK

Maintenance | User Access | Log off | Help

No Scheduled Maintenance | User admin  
08/17/2015 01:11:51  
No Alarm/Trips Present | Run Hours 0

Figure 23-1. Help Screen - Manual

## Section 23 • Help Screen

Back:

- Pressing the back button will rewrite the file/folder list with the previous folder level.

Display Window:

- This window displays the content of the manual.

Fullscreen:

- Pressing this button expands the display window to fit the entire screen.

Page:

- Allows the operator to enter the page number he wishes to see displayed in the window.

Previous:

- Goes to the previous page.

Next:

- Goes to the next page.

Version:

- Pressing the Version button displays a pop-up screen that gives the operator information on the software version running on the Vission 20/20, see Figure 23-3.

Figure 23-2. Help Screen - USB

Figure 23-3. Version Pop-Up Screen

## Section 24 • Twin Screw Control

### Overview

The Vission 20/20 is capable of operating a twin screw compressor from a number of different manufacturers. The Vission 20/20 currently operates as a twin screw controller in the full time oil pump and the no oil pump configuration.

### Setup - Configuration Screen

Configuration Screen:

- To setup the Vission 20/20 panel for twin screw, navigate to the Configuration Screen, page 2, and select “VRS” from the dropdown box labeled “Compressor”, see Figure 24-1.

Menu Changes:

When selecting the twin screw option there will be other changes that occur in other menu pages.

- Volume position indicator will disappear from the main screen and right data panel.
- Prelube oil pump alarms and trip values will be changed to default values for the twin screw
- Run oil pump alarm and trip values will be changed to default values for the twin screw.

The screenshot shows the Configuration Screen for the Twin Screw Option. The interface is organized into several panels:

- Compressor:** A dropdown menu is set to "VRS". Below it, "CFM" is set to 600 and "Refrigerant" is set to "R717".
- Compressor Control:** A section titled "# Controllers" with a sub-section for "Compressor Control". It includes:
  - Suction Pressure Control (set to 2)
  - Process Control (set to 1)
  - Temperature
  - Pressure
  - Discharge Pressure Control (set to 1)
- Optional Function Selection:** Includes:
  - Compressor VFD
  - Oil Restriction Solenoid
- Superheat:** Includes:
  - Suction Superheat Monitor
  - Discharge Superheat Monitor
- Condenser Control:** Includes:
  - Ambient Sensor
  - Wetbulb Sensor
  - VFD Fan
- Touchscreen:** Features "Calibrate" and "Washdown" buttons, and checked options for "Screen Saver" and "Display Background Image".
- Oil Pump:** Includes radio buttons for "No Pump" (selected), "Cycling", and "Full Time".
- Oil Cooling:** Includes radio buttons for "Thermosyphon", "H2O Oil Cooler", "Liquid Injection" (selected), and "Remote Oil Cooler". Under "Liquid Injection", there are radio buttons for "Solenoids" (selected) and "Motorized Valve", and a checkbox for "VFD Fan".
- Motor Current Device:** Includes radio buttons for "Current Transformer" (selected) and "4-20ma Transmitter".
- Alarms and Trips:** Includes an unchecked checkbox for "Idle Time Trip".
- Daily Auto Backup Settings:** Includes "Time" settings: "Hour" set to 12, "Minute" set to 0, and a dropdown menu set to "AM".

At the bottom, there is a "Page" navigation bar with buttons for pages 1 through 8 (page 2 is highlighted), and "Apply" and "Close" buttons.

Figure 24-1. Configuration Screen - Twin Screw Option



## Section 24 • Twin Screw Control

### Operation

Once the twin screw is configured, its operation is very similar to the single screw's, and all options that are available for single screw configuration are also available for twin screw. The only operational difference is the manual mode of operation. Twin screw compressors can experience leaky slide seals that can cause the capacity slide to drift after it has been positioned by the controller. To counteract the capacity slide drift problem, the twin screw manual mode operation has an added anti-drift feature that automatically maintains the position of the hydraulic actuator.

### Slide Calibration - Capacity Slide Valve Potentiometer

This section provides critical information and control parameters related to the capacity slide actuator. The "% cap" display shows the actual percentage value of the capacity slide without any conditioning that might

be applied to the other capacity position displays. In addition, this section displays the value of the actuator's signals in millivolts in the "input Value" display box, see Figure 24-2.

"-" Button:

- When the operator presses and holds this button, the output associated with the capacity slide decrease solenoid is energized and the oil pump is energized. The oil pump is needed to force oil into the capacity slide chamber to move the capacity slide.

"+" Button:

- When the operator presses and holds this button, the output associated with the capacity slide increase solenoid is energized and the oil pump is energized. The oil pump is needed to force oil into the capacity slide chamber to move the capacity slide.

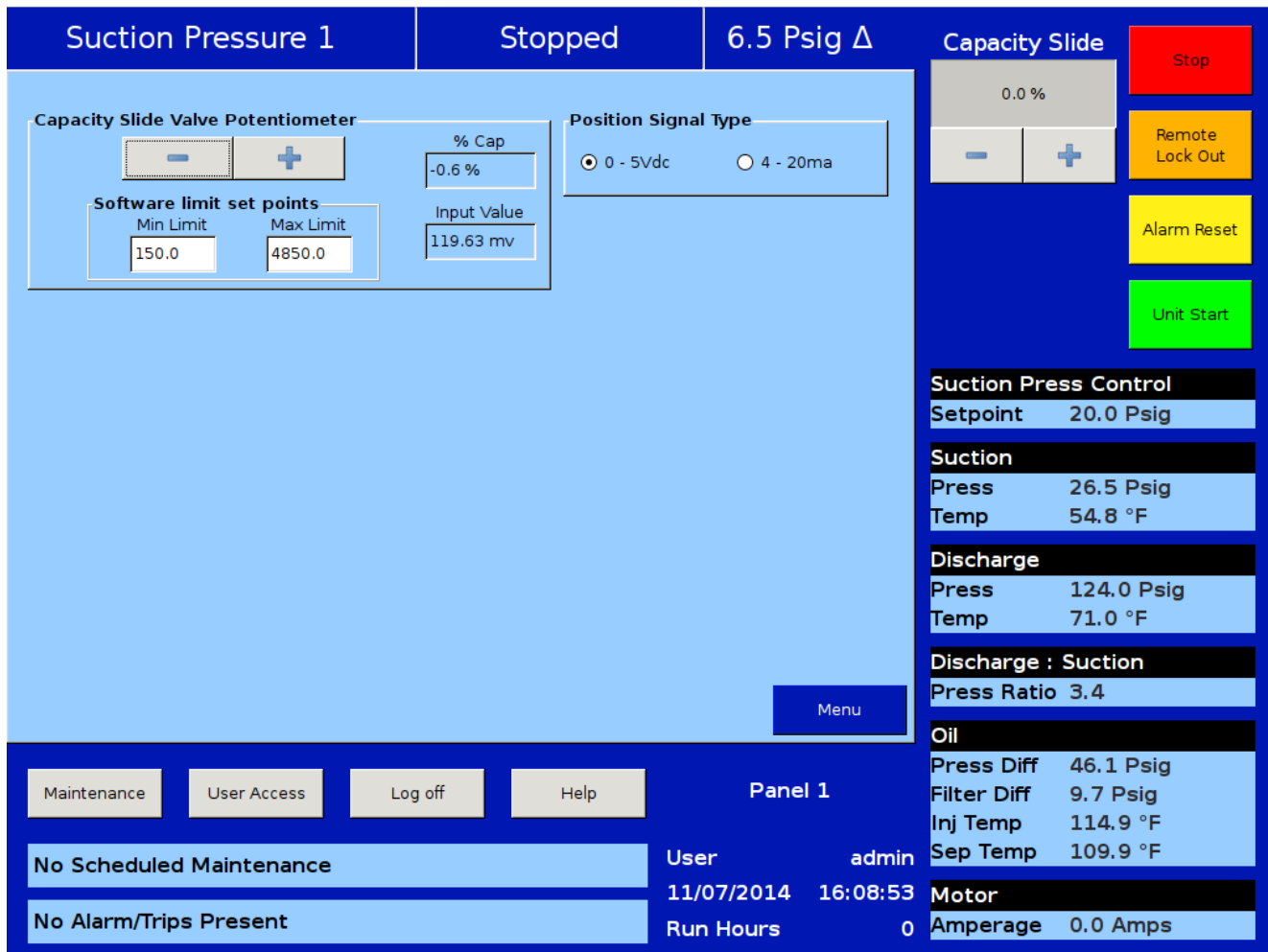

Figure 24-2. Slide Calibration - Fixed VI



## Section 24 • Twin Screw Control

### Software limit setpoints

The Vission 20/20 uses the “Min Limit” and “Max Limit” setpoints to define an area within the mechanical stops for normal slide travel. These software limits’ purpose is to prevent the slide from actually hitting the mechanical stops which could result in a number of undesirable consequences. By default, the software limits are set to 150mV from either end point. The position percentage is calculated from the software limits. Therefore, it is possible to read a value greater than 100% or less than 0% if inertia carries the slides after these limits are reached.

Fixed VI:

- The normal software limits apply without any modification.

Continuous VI:

- “Max Limit” when VI is maximum will be different from “Max Limit” when VI is minimum. Max limit (Min VI)’s value will be greater than Max Limit (Max VI)’s value. The default value for Max Limit (Max VI) is 3440.0 and the default value for Max Limit (Min VI) is 4850.0

Step VI:

- Max limits for Step 1, Step 2 and Step 3 will be different. Step 1’s Max Limit will be greater than Step 2’s Max Limit which will be greater than Step 3’s Max Limit.

The screenshot displays the control interface for the Capacity Slide Valve Potentiometer (Continuous VI). It features a central diagram showing Capacity Movement (right arrow) and Volume Movement (left arrow) relative to a 100% capacity point. Below this, the software limit setpoints are defined:

Min Limit	Max Limit (Max VI)	Max Limit (Min VI)
150.0	3440.0	4850.0

The Volume Slide Valve Potentiometer section also shows its software limit setpoints:

Min Limit	Max Limit
150.0	4850.0

Additional interface elements include a Position Signal Type selector (0 - 5Vdc selected), a % Cap readout (-0.6%), an Input Value (119.63 mv), and a % Vol readout (-2.8%). The right sidebar provides real-time process data:

Suction Press Control	
Setpoint	20.0 Psig
Suction	
Press	26.5 Psig
Temp	55.2 °F
Discharge	
Press	123.8 Psig
Temp	71.2 °F
Discharge : Suction	
Press Ratio	3.4
Oil	
Press Diff	46.4 Psig
Filter Diff	9.5 Psig
Inj Temp	115.1 °F
Sep Temp	110.3 °F
Motor	
Amperage	0.0 Amps

The bottom status bar indicates 'No Scheduled Maintenance' and 'No Alarm/Trips Present'. The user is 'admin' and the system time is 11/07/2014 16:12:19. Run Hours are 0.

Figure 24-3. Slide Calibration - Continuous VI

## Section 24 • Twin Screw Control

Position Signal Type:

- Position signals can be 0-5 VDC or 4-20mA to indicate the current slide valve position.

Compressor Bump Pop-Up Window

- This window, which pops up when you press the Menu button to go back, allows the operator to bump the compressor to flush out any oil in the compressor after a slide valve calibration, see Figure 24-5. If the oil level is below the lowest sight glass in the oil separator, then bumping the compressor is recommended.

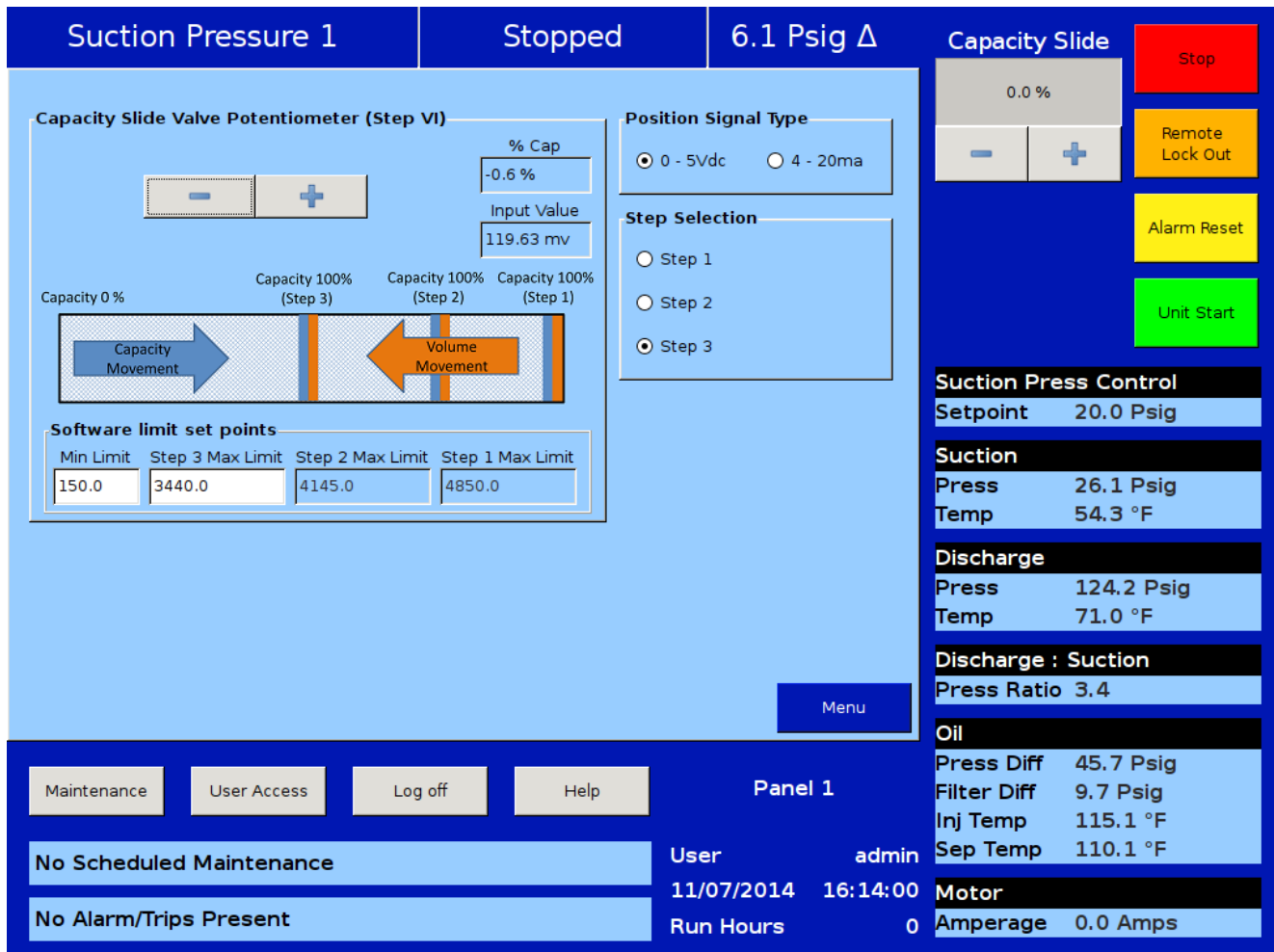

Figure 24-4. Slide Calibration - Step VI

# Section 24 • Twin Screw Control

Suction Pressure 1
Stopped
6.3 Psig Δ

**Capacity Slide Valve Potentiometer**

% Cap  
-0.7 %

**Software limit set points**  
 Min Limit: 150.0  
 Max Limit: 4850.0

Input Value  
118.41 mv

**Position Signal Type**

 0 - 5Vdc     4 - 20ma

**Capacity Slide**

0.0 %

Would you like to turn ON main motor momentarily to flush oil from the compressor at this time?

No Scheduled Maintenance

No Alarm/Trips Present

Panel 1

User: admin

11/07/2014 16:10:51

Run Hours: 0

**Suction Press Control**

Setpoint 20.0 Psig

---

**Suction**

Press 26.3 Psig

Temp 55.2 °F

---

**Discharge**

Press 123.9 Psig

Temp 71.2 °F

---

**Discharge : Suction**

Press Ratio 3.4

---

**Oil**

Press Diff 46.4 Psig

Filter Diff 9.4 Psig

Inj Temp 114.9 °F

Sep Temp 109.9 °F

---

**Motor**

Amperage 0.0 Amps

Figure 24-5. Slide Calibration - Twin Screw Bump Pop-up Window

## Section 24 • Twin Screw Control

### Twin Screw Oil Pressure

The twin screw compressor has two separate oil pressure settings. They are named “Prelube Oil Pressure” and “Run Oil Pressure” in the Alarm and Trips Menu. Both of these oil pressures are calculated in the same way - defined as “Filter Outlet Pressure minus Discharge Pressure”.

As shown in Figure 24-6, the alarm and trip setpoints for both of these oil pressures are set to the same values and any adjustments to these oil pressures is usually done so that the setpoints are the same.

### OIL PRESSURE MONITORING BEFORE COMPRESSOR STARTS

Pressing the “Auto” or “Manual” options from the “Unit Start” pop-up window will start the oil pump. The decrease solenoid will be energized as well if the capacity slide is greater than 5%. A prelube oil pressure timer called “Minimum Compressor Prelub Time” begins

timing, see Figure 24-7. This timer is adjustable, while the default time is 5 seconds. This timer allows oil to be pushed into the oil injection lines to fill the lines with oil BEFORE the system starts looking for prelube oil pressure. After the Minimum Comp Prelub Timer times out, then prelube oil pressure monitoring begins. The oil pump will run for the time setting of “Prelube Oil Pressure Monitor Time” (typically 20 seconds) trying to achieve prelube oil pressure. If it fails to establish prelube oil pressure, the oil pump shuts down for 10 seconds, and then starts and tries again. The cycle is repeated for the “Prelube Oil Pressure Monitor Trials” setting, typically set at “3” tries. After the third unsuccessful try, a failure message “Prelube Oil Pump Inhibit” is generated. This indicates a failure to establish Prelube Oil Pressure. When the Prelube Oil Pressure is established, then the compressor is commanded to start.

### LOW OIL PRESSURE SAFETY BYPASS

When the compressor starts, then the Low Oil Pressure Safety Bypass timer is started (set at 60 seconds by default, but it is adjustable).

The screenshot displays the control interface for a twin screw compressor. At the top, it shows 'Suction Pressure 2' at 'Stopped' with a change of '-6.9 Psig Δ'. The main panel is titled 'Alarm Trip' and contains the following settings:

Parameter	Alarm	Trip
Prelube Oil Pressure	4.0 Psig	2.0 Psig
Run Oil Pressure	38.0 Psig	35.0 Psig
High Filter Diff Start Pressure	45.0 Psig	50.0 Psig
High Filter Diff Run Pressure	12.0 Psig	15.0 Psig
High Motor Amps	15.0 Amps	15.0 Amps
Oil Over Pressure		100.0 Psig

On the right side, there are control elements: a 'Capacity Slide' at 3.5% with 'Stop' and 'Remote Lock Out' buttons; a 'Volume Slide' at 0.7% with an 'Alarm Reset' button; and a green 'Unit Start' button. Below these are status displays for 'Suction Press Control' (Setpoint 30.0 Psig), 'Suction' (Press 23.1 Psig, Temp 42.9 °F), 'Discharge' (Press 147.2 Psig, Temp 175.0 °F), and 'Discharge : Suction' (Press Ratio 4.3). The 'Oil' section shows 'Press Diff 141.3 Psig', 'Filter Diff 10.1 Psig', 'Inj Temp 103.7 °F', and 'Sep Temp 109.9 °F'. At the bottom right, 'Motor Amperage' is 1.2 Amps. The bottom left shows 'No Scheduled Maintenance' and 'No Alarm/Trips Present'. The bottom right shows user 'admin', date '07/04/2017', time '01:32:17', and 'Run Hours 15'. Navigation buttons for 'Maintenance', 'User Access', 'Log off', and 'Help' are at the bottom left.

Figure 24-6. Prelube Oil Pressure and Run Oil Pressure Settings

## Section 24 • Twin Screw Control

During this time, the Prelub Oil Pressure Alarm and Trip setpoints are forced into the Run Oil Pressure Alarm and Trip settings. By default, the Prelub Oil Pressure Alarm and Trip setpoints and the Run Oil Pressure Alarm and Trip settings are the same values, however these settings are adjustable. In some cases it may be advantageous to set the Prelub Oil Pressure Alarm and Trip setpoints to a lower value than the Run Oil Pressure Alarm and Trip setpoints. This will provide more time for the screw compressor to develop running oil pressure after the compressor starts.

After the Low Oil Pressure Safety Bypass Timer expires, the Run Oil Pressure Alarm and Trip setpoints revert to their normal setpoints. At this time, or anytime thereafter, if the oil pressure does not exceed the Run Oil Press Trip setpoint, then the compressor will fail because of “Run Oil Pressure”.

### OIL PRESSURE MONITORING AFTER COMPRESSOR STARTS

After oil pressure exists and assuming that the capacity slide is less than 5%, the compressor now starts. During the first 5 minutes of the compressor running, if the oil pressure drops to the “Low Oil Pressure Trip” value (or below) for five continuous seconds (settable by a timer called “Oil Pressure Fail Delay” timer), then the compressor will fail on “Low Run Oil Pressure” failure. After five minutes of the compressor running, then if the oil pressure ever drops to the low oil pressure trip value (or below), then the compressor will immediately fail on “Low Run Oil Pressure” failure.

Setpoint	Max Limit	Min Limit	Value
			Capacity Increase Start Delay 5 sec
			Minimum Comp. Prelube Time 5 sec
			Low Oil Pressure Safety Bypass 60 sec
			Prelube Oil Pressure Monitor Time 20 sec
			Prelube Oil Pressure Monitor Trials 3
			Prelube Oil Pressure Safety Changeover 10 sec
			High Filter Diff. Press Safety Changeover 60 sec
			Oil Level #1 Trip Delay 60 sec
			Oil Level #2 Trip Delay 60 sec
			Low Oil Sep. Temp. Safety Changeover 5 min
			Low Oil Injection Safety Bypass 6 min

Suction Press Control	
Setpoint	20.0 Psig
Suction	
Press	39.8 Psig
Temp	8.6 °F
Discharge	
Press	109.7 Psig
Temp	-37.8 °F
Discharge : Suction	
Press Ratio	2.3
Oil	
Press Diff	182.2 Psig
Filter Diff	-19.3 Psig
Inj Temp	81.5 °F
Sep Temp	113.7 °F
Motor	
Amperage	0.0 Amps

Figure 24-7. Timers Menu - Twin Screw Control

## Section 25 • Cool Compression Control

### Overview

The cool compression operation is similar to the one of the standard single screw compressor units, except there is no external oil cooler to the unit. A blanket of liquid ammonia lies on top of the oil in the oil separator. The liquid ammonia level is regulated by sensing the liquid ammonia level with a level probe, and using a positioning valve to vary the amount of liquid ammonia being added to the separator. The cooling occurs through the entire compression and separation process. The Cool Compression compressor does not have an oil pump. When the Cool Compression compressor unit is commanded to start, the control panel first insures that the slide valves are at their minimum positions. The suction oil injection solenoid (SOI) is energized – allowing a path for oil to flow into the compressor. The compressor now starts. There is an initial pressure drop in the suction chamber of the compressor and a corresponding increase in pressure on the discharge of the compressor. This creates a pressure differential that forces the

oil and liquid ammonia mixture through the suction oil injection line into the suction chamber of the compressor. This oil and liquid provides lubrication and cooling until full pressure differential lubrication is attained. As the differential pressure increases, the oil and liquid ammonia is now injected into the screw during the compression process and the oil injection valve is allowed to close.

### Setup

Configuration Screen:

- To setup the Vission 20/20 panel for Cool Compression, first ensure that an analog output card is installed in the panel, and it is selected from page 6 of the configuration screen, see Section 19. Navigate to configuration page 2, and select “Cool Compression” checkbox from the Special Compressor Settings Section, see Figure 25-1. Once selected, the “Cool Compression” option will appear

The screenshot shows the configuration screen for a Vission 20/20 panel. The interface is organized into several sections:

- Compressor:** VSS (dropdown), Model 451 (dropdown), Refrigerant R717 (dropdown).
- Compressor Control:** # Controllers: 1.  Suction Pressure Control,  Process Control,  Discharge Pressure Control. Radio buttons for Temperature and Pressure.
- Optional Function Selection:**  Compressor VFD,  Oil Restriction Solenoid.
- Superheat:**  Suction Superheat Monitor,  Discharge Superheat Monitor.
- Condenser Control:**  Ambient Sensor,  Wetbulb Sensor,  VFD Fan.
- Touchscreen:** Calibrate, Washdown,  Screen Saver,  Display Background Image (highlighted with a red arrow).
- Oil Pump:**  No Pump,  Cycling,  Full Time.
- Oil Cooling:**  Thermosyphon,  H2O Oil Cooler,  Liquid Injection,  Remote Oil Cooler,  VFD Fan.
- Motor Current Device:**  Current Transformer,  4-20ma Transmitter.
- Alarms and Trips:**  Idle Time Trip.
- Special Compressor Settings:**  Cool Compression,  Rapid Cycling VFD,  Suction Oil Injection Solenoid,  Oil Flow Control,  Heat Pump. Discharge Pressure (Psig): 460, Differential Pressure (Psig): 380.
- Daily Auto Backup Settings:** Time: Hour 12, AM, Minute 0.

Page navigation: 1, 2, 3, 4, 5, 6. Buttons: Apply, Close.

Figure 25-1. Configuration Screen

## Section 25 • Cool Compression Control

in the Oil Pump and Oil Cooling sections, selected automatically. It will also enable Superheat Monitoring on the screen.

- As previously described, Cool Compression compressor does not have an oil pump. Instead it has a suction oil injection solenoid to provide oil and liquid ammonia for lubrication and cooling.
- Cool Compression liquid injection 1 and liquid injection 2 outputs will operate as high / low pressure ratio solenoid outputs.

### Control Functions

In the Compressor Control Menu, special cool compression control functions are now available, see Figure 25-2.

#### Auto Load

- Auto load operation will force the compressor to load to a minimum value once the compressor has started. By loading the compressor to a minimum value, and maintaining this capacity, a pressure ratio is created across the compressor, to ensure its adequate lubrication, and also so that the compressor does not experience high discharge superheat conditions. Since compressor lubrication is of great importance, all load limiting is disabled when auto load is engaged.
- Auto Load at Start
  - Defines the value at which Compressor (capacity slide) should be loaded (and maintained) at start if Auto Load is enabled.
- Auto Load Timer
  - This timer defines the maximum time that the Auto Load operation will be engaged. After the timer expires, Auto Load will be disengaged.
  - Auto load will be disengaged when one of the

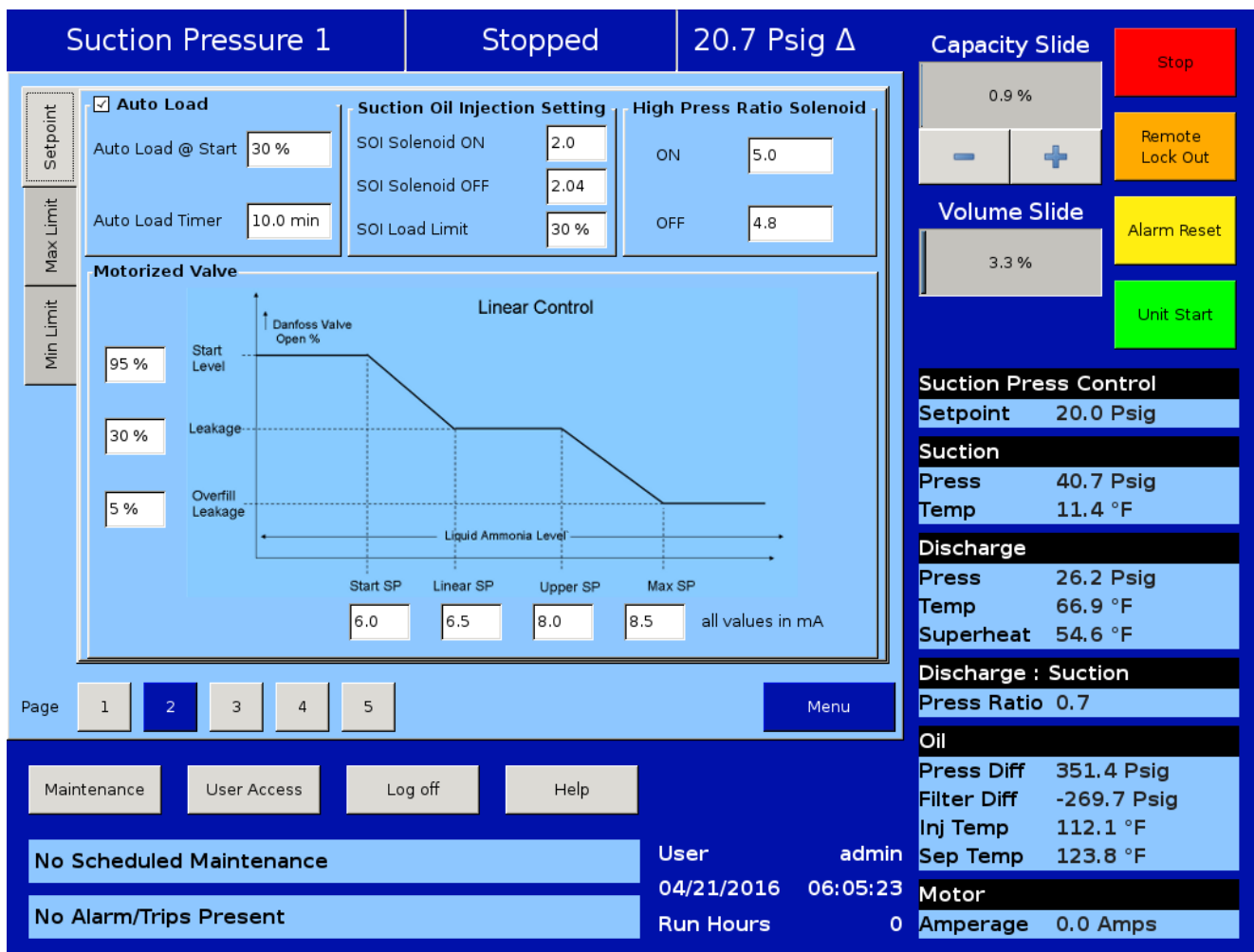

Figure 25-2. Compressor Control Screen - Cool Compression Control (Page 2)



## Section 25 • Cool Compression Control

---

following conditions occur;

- Pressure ratio reaches a value of 2.0 or greater.
- Compressor has been running for 10 minutes (defined by Auto Load Timer).
- The suction pressure setpoint has been reached.

### Suction Oil Injection Setting

- In order to maintain adequate lubrication during low pressure ratio conditions, the Suction Oil Injection (SOI) solenoid is turned ON and the capacity of the compressor is reduced.
- The SOI solenoid will cycle ON and OFF based on the pressure ratio across the compressor.
- SOI Solenoid ON
  - Defines the Pressure ratio value at which SOI is turned ON (default 2.00) (Digital Output Board #1:2).
- SOI Solenoid OFF
  - Defines the Pressure ratio value at which SOI is turned OFF (default 2.04) (Digital Output Board #1:2).
- SOI Load Limit
  - Defines the capacity slide position at which the compressor capacity slide will unload to if pressure ratio falls below “SOI Solenoid ON” setpoint. This setpoint is not active until Auto Load disengages.
- The SOI solenoid will also cycle on if the discharge temperature superheat reaches a value of 5°F (this value is not settable). Generally, anytime the SOI solenoid cycles on, the capacity is limited to the SOI Load Limit setpoint. However, this is not true if the SOI solenoid cycles on based on the discharge temperature superheat 5°F rule. If discharge temperature superheat continues to climb and reaches a value of 6°F, the compressor will be inhibited from loading. If discharge temperature superheat still continues to climb and reaches a value of 8°F or more, then the compressor will be unloaded until the superheat drops below 8°F or the capacity has reached the SOI Load Limit setting.

### Using a Positioning Valve for Liquid Ammonia Level Control

- A level probe inserted in the oil separator detects the liquid ammonia level. Based on the level of the ammonia (0-100%), the level probe sends a directly proportional 4-20 mA signal to the Vission 20/20 panel. The positioning valve is then positioned based on the Positioning Valve settings graph shown in Figure 25-2.
- Looking at the graph, when the compressor starts, the positioning valve placement (Vertical Axis) is determined based on the liquid ammonia level that is sensed in the oil separator (Horizontal Axis). It can be seen that as the liquid ammonia level increases (corresponding to a larger mA value), the positioning valve moves towards a closed position.
- The Positioning Valve’s position (0-100% limits) is defined at three distinct levels:
  - Start Level (lowest liquid ammonia level - positioning valve at maximum open position).
  - Leakage (normal operating position and ammonia level).
  - Overfill Leakage (highest liquid ammonia level – positioning valve at minimum open position).
- Liquid ammonia levels are defined at four distinct levels (4-20ma limits);
  - Start SP (minimum liquid ammonia level in separator – the positioning valve is at its maximum opening).
  - Linear SP (minimum level of liquid ammonia for normal operating position).
  - Upper SP (maximum level of liquid ammonia for normal operating position).
  - Max SP (maximum liquid ammonia level – positioning valve is at its minimum opening position, maintaining some leakage).
- On the Alarms and Trips screen, the Low Oil Separator Start Temperature and High Filter Diff Start Pressure settings are disabled.
- On the Timers screen the Oil Level #1 Safety Trip Delay and Oil Level #2 Safety Trip Delay settings are disabled.



## Section 25 • Cool Compression Control

### Operational Differences from Single Screw

Once the Cool Compression is configured, most setup options available for a single screw are also available for Cool Compression. However, there are significant operational differences that are mostly associated with the compressor safeties:

1. The Cool Compression program ignores,
  - Low Oil Separator Alarm / Trip at start
  - High Filter Differential at start
  - Prelube Oil Pressure Alarm and Trip
  - Run Oil Pressure Alarm and Trip (Pressure Ratios are monitored instead).
  - High Discharge Temp Alarm and Trip (Discharge Temp Superheat is monitored)
  - Low Suction Temp Alarm and Trip
  - Low Oil Injection Temp Alarm and Trip
  - High Oil Injection Temp Alarm and Trip
2. SOI solenoid is forced on for first 60 seconds of running and 10 minutes after compressor is stopped.
3. Auto Load Enabled: When Auto Load is engaged at start, it then maintains the position of the capacity slide to the Auto Load limit (approx: 30 %, but less than 50 %). It displays a status message, “Cool Compression Capacity Hold”, when it is running. Unless Auto load is disengaged the compressor will run at the auto load limit position. Auto load disengages if enough Pressure Ratio is built (typically more than 2.04) or setpoints are achieved.
4. SOI Solenoid: During normal operation if the pressure ratio drops to a lower value (typically below 2.00) then it energizes the SOI solenoid and maintains the position of the capacity slide to the SOI Load limit (approx : 30 %, less than 50 %). It also displays a status message, “Cool Compression Capacity Hold”. If enough Pressure Ratio is built across the compressor (typically more than 2.04), it again resumes the run and control mode normally.
5. It performs Cool Compression specific checks periodically like:
  - Controlling the liquid level positioning valve as liquid ammonia level changes .
  - Low / high Pressure Oil Injection ports control as Pressure Ratio and Superheat temperature changes.

### Supplemental Oil Cooling Solenoids

- Some cool compression units will have supplemental oil cooling solenoids. One is called the suction liquid injection solenoid and is controlled via discharge superheat. When the discharge superheat reaches 5°F, the solenoid is turned on. When it falls back to below 4°F, the solenoid is turned off. An additional solenoid (referenced as SV4 – as called the High Press Ratio solenoid) provides supplemental oil cooling based on pressure ratio. When the pressure ratio rises above 5.0, the solenoid is turned on. When the pressure ratio falls back to below 4.8, the solenoid is turned off.

### Level Switches

- There are two level switches in the oil separator, a “high” and a “low”. During normal running operation, the oil level is above both switches. When the oil level starts to drop and opens the high level switch, a 10 minute timer starts. When the timer elapses a flashing “add oil to middle of sight glass” message appears on the main screen. When the operator adds enough oil to close the high level switch, the message disappears.

## NOTICE

**If oil is not added and the oil level continues to drop thereby opening the “low” oil level switch, a 10 minute timer starts again. When the timer elapses, the compressor shutdowns immediately and displays “Low Oil Level” failure. If enough oil is added to close the low level switch, then this will allow the operator to press the reset button and clear the “Low Oil Level” failure and “Add Oil” message.**

### Oil Level Messaging After Compressor Stops

- The low level switch is monitored after the compressor stops. If the switch opens after the compressor stops, a two minute timer starts. If the switch stays open, and the timer expires, a failure is generated called “Lo Oil Level Fail after Stop” and the compressor is disabled from restarting until oil is added to close the low level switch. Note that this failure is generated ONLY when the low level switch opens after the compressor stops.

## Section 26 • Remote Oil Cooler

### Overview

This screen allows the operator to view and adjust Remote Oil Cooler setpoint settings associated with Remote Oil Cooler operation, see Figure 26-1. This screen will only be active if the Remote Oil Cooler Control option has been enabled from the Configuration Screen, see Section 19.

The Remote Oil Cooler Control operation allows the cycling of fans and pumps in order to maintain a specific Remote Oil Cooler Temperature. The five different steps in step control allow the selection of fans, pumps and VFD in one or more steps. When a VFD is employed, the VFD is allowed to reach maximum speed, then if additional capacity is needed, the next fan or pump is brought on. The VFD will modulate down and then back up to 100% again, then the next fan or pump is brought on. This method allows the smoothest Remote Oil Cooler control by spacing the VFD between the fan and pump steps, while maintaining a Remote Oil Cooler Temperature pressure that matches the setpoint.

### Remote Oil Cooler Setpoint

Run Mode:

- Run Mode allows the selection of different modes of operation for Remote Oil Cooler. The choices for selection are:

Run Never:

The mode of operation by default. Remote Oil Cooler operation will not be performed when this mode is active.

Run With Comp:

Automatic operation of Remote Oil Cooler selected when cooling control is required to only run when the compressor is running.

Run Always:

Automatic operation of Remote Oil Cooler selected when cooling control is required to run even when the compressor is off.

The screenshot displays the Remote Oil Cooler control interface. At the top, it shows 'Suction Pressure 1' at 'Stopped' with a pressure difference of '6.2 Psig Δ'. The main control area includes a 'Run Mode' section with radio buttons for 'Run Never' (selected), 'Run With Comp', 'Run Always', and 'Manual'. Below this are input fields for 'Remote Oil Cooler Temp' (0.0 °F), 'Remote Oil Cooler Temp Setpoint' (120.0 °F), 'Upper Deadband' (5.0 °F), and 'Lower Deadband' (5.0 °F). A 'High to Low Speed Fan Delay' is set to 15 sec. A table for 'Remote Oil Cooler Control' lists five steps, each with checkboxes for 'Out #1' through 'Out #4', 'VFD', 'Step Delay' (15 sec), 'Low Speed Fan' (None), and 'Control' (OFF). On the right, there are 'Capacity Slide' and 'Volume Slide' controls, both at 0.0%, and buttons for 'Stop', 'Remote Lock Out', 'Alarm Reset', and 'Unit Start'. The bottom right corner shows real-time data for 'Suction Press Control' (Setpoint 20.0 Psig), 'Suction' (Press 26.2 Psig, Temp 55.0 °F), 'Discharge' (Press 128.4 Psig, Temp 71.2 °F), 'Discharge : Suction Press Ratio 3.5', and 'Oil' (Press Diff 144.2 Psig, Filter Diff 9.4 Psig, Inj Temp 113.5 °F, Sep Temp 110.3 °F). The bottom left shows 'Motor' (Amperage 0.0 Amps). The bottom navigation bar includes 'Maintenance', 'User Access', 'Log off', 'Help', 'Panel 1', 'User admin', '11/07/2014 13:15:47', 'Run Hours 0', and status messages: 'No Scheduled Maintenance' and 'No Alarm/Trips Present'.

Figure 26-1. Remote Oil Cooler Screen (Page 1)

## Section 26 • Remote Oil Cooler

### Manual

- Mode for controlling the Remote Oil Cooler operation manually. The operation is controlled by manual stepping using an on/off toggle button at each step.

### Remote Oil Cooler Temperature:

- This is a read-only parameter and it displays the present value of the Remote Oil Cooler Temperature. The Remote Oil Cooler Temperature is mapped on Analog Auxiliary Input #5.

### Remote Oil Cooler Temperature Setpoint:

- This is the Remote Oil Cooler Temperature setpoint that needs to be maintained.

### Upper Deadband:

- This is the Remote Oil Cooler Temperature setpoint's upper deadband value.

### Lower Deadband:

- This is the Remote Oil Cooler Temperature setpoint's lower deadband value.

### High to Low Speed Fan Delay:

- This is time delay for fan spin down in case of 2 speed motor/dual speed fan.

## Step Control

The Step Control allows the operator to setup the manner in which Fans, Pumps & VFD will be turned on/off. Fans & Pumps are connected on digital outputs Out #1 to Out #4. The VFD Fan is connected to the Analog Output. Each step can have a maximum of five outputs connected to it. Each step can be opted in or out depending an enabled checkbox.

When the Run Mode is "Auto" and the Remote Oil Cooler Temperature rises above the upper deadband, the Remote Oil Cooler step gets increased from Step 1 to Step 5, hence switching on/off Pumps, Fans & VFD connected to outputs. This holds true when it comes to decreasing the steps from Step 5 to Step 1 when the Remote Oil Cooler Temperature falls below the lower deadband.

### Step Delay:

- Allows the operator to set time delays between the Remote Oil Cooler steps. Remote Oil Cooler Temperature must be outside the upper or lower deadband continuously for the delay time in order to increase or decrease the Remote Oil Cooler steps. While in a VFD step, an additional step can only be added once the VFD has reached its maximum speed

setpoint and the delay timers are satisfied. Similarly in a VFD step, a step can only be removed once the VFD has reached its minimum speed setpoint and the delay timers are satisfied. The Step Delay acts as an "ON" timer while loading and acts as an "OFF" timer while unloading for the same step.

### Low Speed Fan:

- Allows steps to have an option for time delay in case of fan spin down. Any of Out #1 to Out #4 can be selected as Low Speed Fan through combo box. E.g.: Let's say Out #2 is selected as Low Speed Fan in Step 2. When step 2 becomes active during Remote Oil Cooler operation, which is after Step 2's timeout delay, Out #2 is left off for the time set by the operator in High to Low Speed Delay. After the low speed fan energizes, then the timer for Step 3 starts timing.

### Control:

- Toggle any of the steps On/Off during the manual operation of the Remote Oil Cooler. This button is active only when the Run Mode selected is "Manual". During "Auto" operation of the Remote Oil Cooler Control, the control button for the active step will be "ON".

## VFD Settings

This page is active only when Remote Oil Cooler VFD is selected in the Configuration Screen, see Section 19. For the Remote Oil Cooler VFD Screen, see Figure 26-2. When a VFD fan is used for the Remote Oil Cooler oil cooling, the speed of the VFD is controlled using a PID algorithm.

### P = Proportional (gain):

- Used to adjust the fan speed action in direct proportion to the difference between the control setpoint and the process variable ( $SP - PV = \text{error}$ ). The proportional term is a unitless quantity and is used for coarse adjustment. This setpoint should be set to the lowest value that gives adequate control system response. Increasing the proportional setting increases the control system's sensitivity to small process fluctuations and the tendency to hunt.

### I = Integral (reset):

- Used to adjust the capacity control action, integrating the error over time, to account for a small error that has persisted for a long time. This quantity is used for fine adjustment. This setpoint is used to smooth out process variations. This setpoint should

## Section 26 • Remote Oil Cooler

be set high enough to prevent hunting but not too high or it will cause control system overshoot.

D = Derivative (rate):

- Used to adjust the capacity control action, accounting for how fast the error is changing, positively or negatively.

Maximum Speed:

- This setpoint defines the percentage maximum speed for the Remote Oil Cooler VFD Fan to run for the continuous step delay time to increase the Remote Oil Cooler steps. E.g. let's say setpoint is kept at 95%. Then the Remote Oil Cooler VFD fan will have to run at a speed of 95% or more to advance to the next step. The Maximum Speed can be set as 100%, which is when the analog output (at which the Remote Oil Cooler VFD fan is connected) reaches 20mA in its normal range of 4-20mA.

Minimum Speed:

- This setpoint defines the percentage minimum speed for the Remote Oil Cooler VFD Fan to run for the continuous step delay time to decrease the Remote Oil Cooler steps. E.g. let's say setpoint is kept at 5%. Then the Remote Oil Cooler VFD fan will have to run at a speed of 5% or less to advance to the next step. The Minimum Speed can be set as 0%, which is when the analog output (at which Remote Oil Cooler VFD fan is connected) reaches 4mA in its normal range of 4-20 mA.

**Suction Pressure 1**      **Stopped**      **6.0 Psig Δ**

**VFD Settings**

P	0.0	Minimum Speed	0 %
I	0.0	Maximum Speed	100 %
D	0.0		

**Capacity Slide**  
0.0 %

**Volume Slide**  
0.0 %

**Suction Press Control**  
Setpoint 20.0 Psig

**Suction**  
Press 26.0 Psig  
Temp 54.6 °F

**Discharge**  
Press 128.5 Psig  
Temp 71.7 °F

**Discharge : Suction**  
Press Ratio 3.5

**Oil**  
Press Diff 144.2 Psig  
Filter Diff 9.8 Psig  
Inj Temp 113.1 °F  
Sep Temp 109.6 °F

**Motor**  
Amperage 0.0 Amps

Page 1 2 Menu

Maintenance User Access Log off Help Panel 1

No Scheduled Maintenance      User admin  
11/07/2014 13:12:34  
No Alarm/Trips Present      Run Hours 0

Figure 26-2. Remote Oil Cooler VFD Screen (Page 2)

## Section 27 • Parts

---

### How to Read a Parts List and Illustration

A parts list may consist of the following information:

- Item No.
  - Item number associated with the number shown in the parts illustration.
- Description
  - A description of the item.
- VPN
  - VPN stands for Vilter™ Part Number.

In the associated illustration, Item numbers are listed in a 11 o'clock format to make finding easier.

Sub assemblies are noted by “.” periods. For example, VPN 35197A is a sub assembly of VPN 1833G:

Description	VPN
FILTER, OIL (INCLUDES VPN 35197A)	1833G
.GASKET, OIL FILTER COVER	35197A

Since the Oil Filter Cover Gasket (VPN 35197A) is part of the Oil Filter (VPN 1833G), ordering the Oil Filter (VPN 1833G) will also include the Oil Filter Cover Gasket. Also note that the Oil Filter Cover Gasket can be ordered separately.

### Vilter™ Aftermarket Parts Contact Information

**Phone** 1-800-862-2677

**Fax** 1-800-862-7788

**E-mail** Parts.Vilter@Emerson.com

**Website** [http://www.emersonclimate.com/en-us/services/aftermarket/vilter\\_aftermarket\\_parts/pages/vilter\\_aftermarket\\_parts.aspx](http://www.emersonclimate.com/en-us/services/aftermarket/vilter_aftermarket_parts/pages/vilter_aftermarket_parts.aspx)

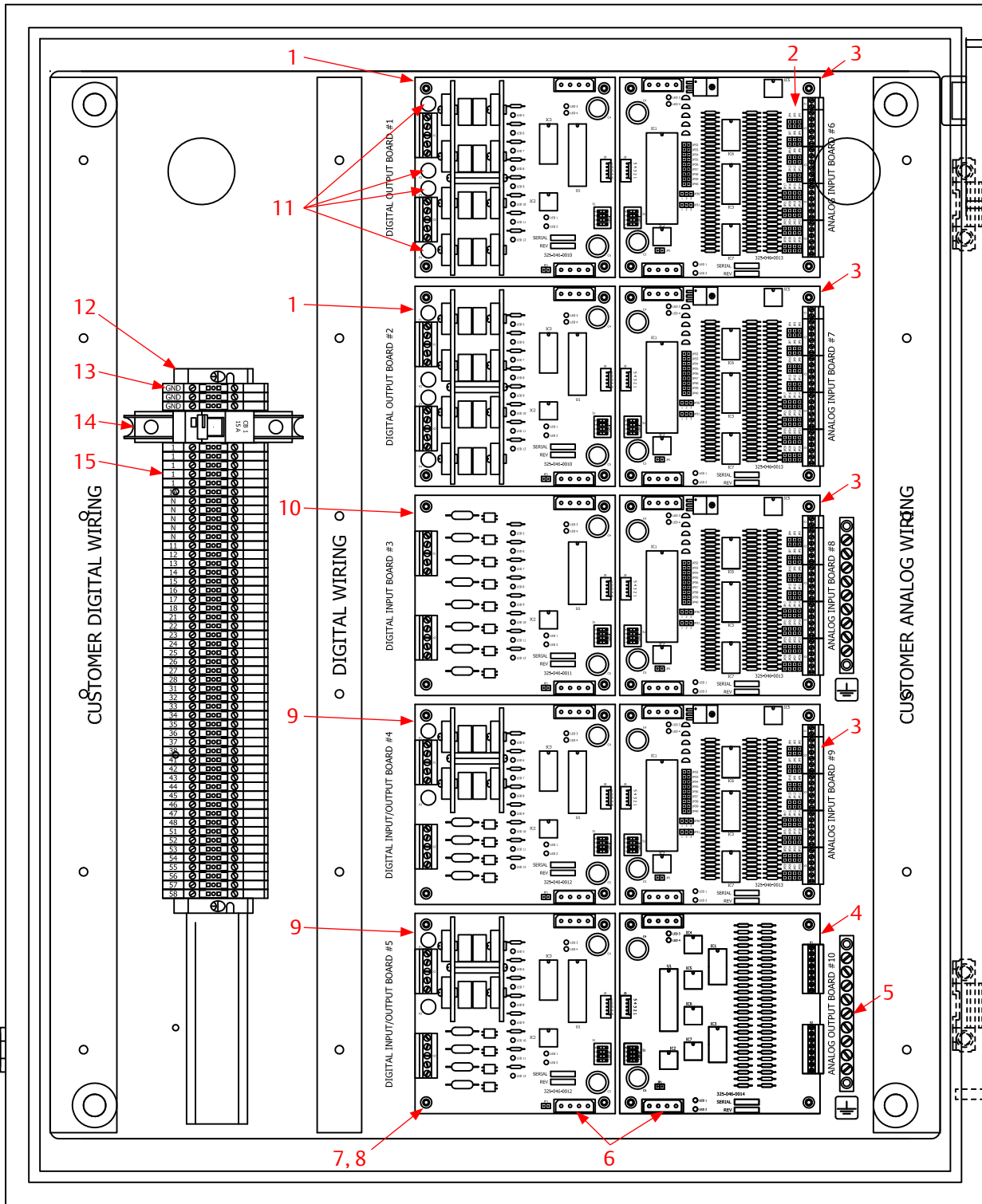

Figure 27-1. Vision 20/20 - Main Enclosure Electrical Components

## Section 27 • Parts

### Vission 20/20 - Main Enclosure Electrical Components

Item No.	Description	VPN
1	DIGITAL OUTPUT BOARD – 8 OUTPUTS	3485DE8
2	PIN JUMPERS-BERG TYPE. RED. BAG OF 100.	3485PJ
3	ANALOG INPUT BOARD – 8 INPUT	3485A8
4	ANALOG OUTPUT BOARD – 8 OUTPUTS	3485AE8
5	GROUND BAR_11 HOLES, 9 CIRCUIT	3485GB
6	CABLE – JUMPER BOARD TO BOARD	3485X
7	STANDOFF #6X6/32X3/4” STEEL METAL HEX	3485SP
8	SCREW 6-32NCX3/8 MACHINE RD HD GALV	2078B
9	DIGITAL INPUT/OUTPUT BOARD – 4 INPUT AND 4 OUTPUT	3485D4
10	DIGITAL INPUT BOARD – 8 INPUTS	3485D8
11	FUSE PACK CONSISTING OF 4-WICKMANN TR5 SUBMINATURE FAST ACTING 370 SERIES 6.3 AMPS 250V	3485F
12	TERMINAL END BLOCK_SMALL_EW 35 DIN	3485TEB
13	TERMINAL BLOCK_GROUND_CPE, DECA DIN	3485TBG
14	CIRCUIT BREAKER – ABB 15AMP-SINGLE POLE	3485V
15	TERMINAL BLOCK_CDU 2.5, DECA DIN	3485TB
16	EMERGENCY STOP SWITCH W/ 1NO, 1NC (ABB CE4P-10R-11)	3485H

# Section 27 • Parts

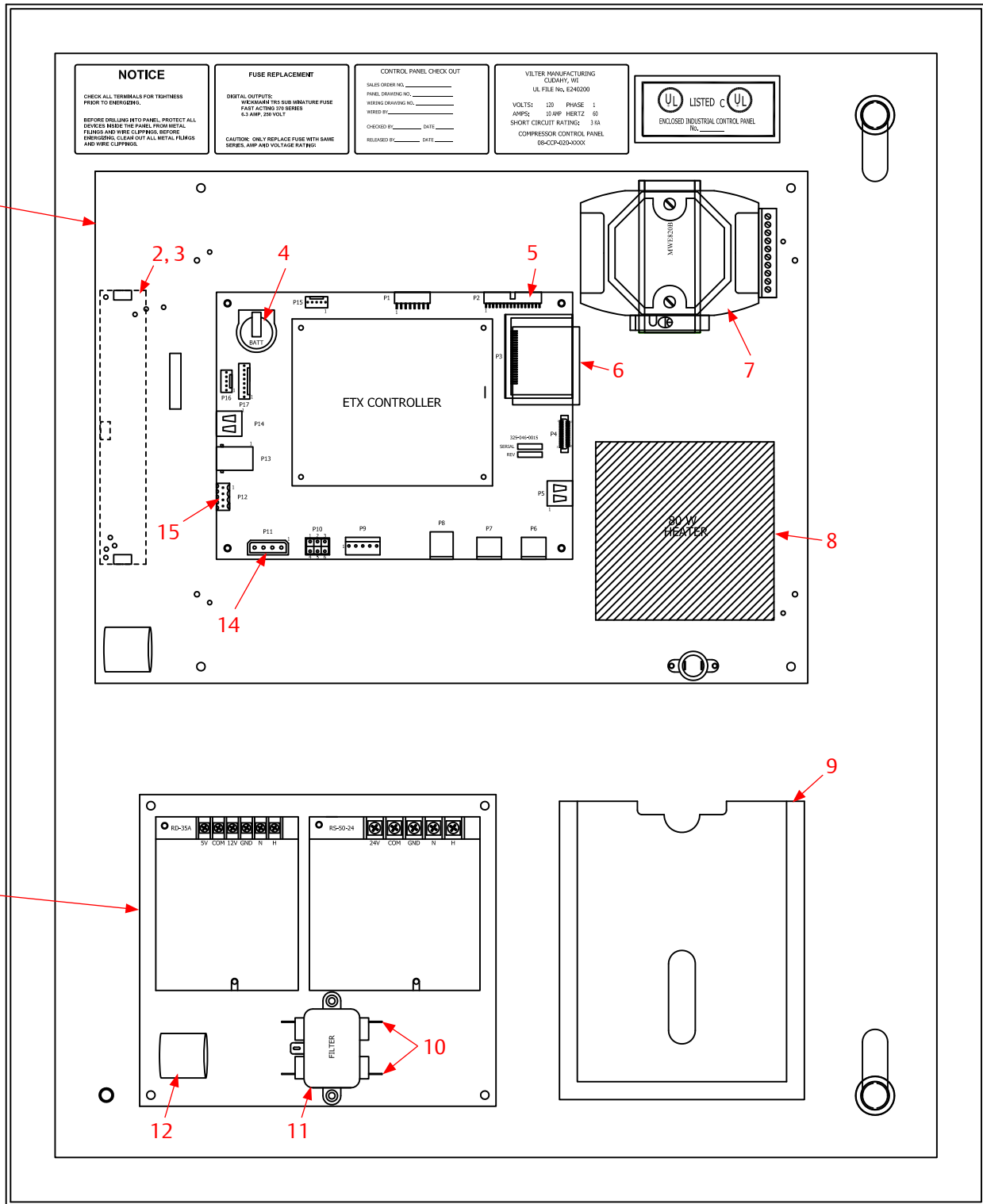

Figure 27-2. Vision 20/20 - Door Interior Components



## Section 27 • Parts

### Vission 20/20 - Door Interior Components

Item No.	Description	VPN
1.1	SBC ASSEMBLY W/FLASHCARD, LINUX OS, 15"XGA INDOOR DISPLAY, INVERTOR BOARD, ATOM CPU, BASEBOARD, MEMORY CARD.	See Figure 27-3
1.2	SBC ASSEMBLY W/FLASHCARD, LINUX OS, 15"XGA OUTDOOR DISPLAY, INVERTOR BOARD, ATOM CPU, BASEBOARD, MEMORY CARD.	See Figure 27-3
2.1	INVERTER BOARD CCFL W/ PWM DUAL INDOOR (ZIPPY)	3485ED
2.2	INVERTER BOARD CCFL W/ PWM DUAL INDOOR (ERG)	3485EDG
2.3	INVERTER BOARD CCFL W/ PWM QUAD OUTDOOR (ZIPPY)	3485EQ
3.1	CABLE – CCFL ZIPPY INDOOR HARNESS	3485WDH
3.2	CABLE – CCFL (ERG) INDOOR HARNESS	3485WDHG
3.3	CABLE – CCFL ZIPPY OUTDOOR HARNESS	3485WQH
4	BATTERY 3 VOLT 2020 CNTRL PANEL	3485MCB
5	CABLE – DISPLAY TO INTERFACE BOARD	3485W
6	FLASH CARD, 2GB	3485FC
7	USB TO SERIAL CONVERTER	3485C
8	PANEL HEATER ASSEM. (CAN BE ADDED TO ANY PANEL) HEATER, THERMOSTAT,, & HARNESS ASSEMBLY	3485PH
9	2020 CABINET DOOR POCKET	3485DP
10	CABLE -VISSION AC FILTER/PS/HEATER HARNESS	3485WVH
11	QUALTEK EMI FILTER, 5A	3485EMF
12	FERRITE BEAD CORE	3485FBC
13	POWER SUPPLY (DUAL) ASSEMBLY ON MOUNTING PLATE W/ WIRING HARNESS	3485K
14	CABLE – CPU TO I/O POWER/COMM CABLE	3485WC
15	ISOLATOR MODBUS RTU	3485C1

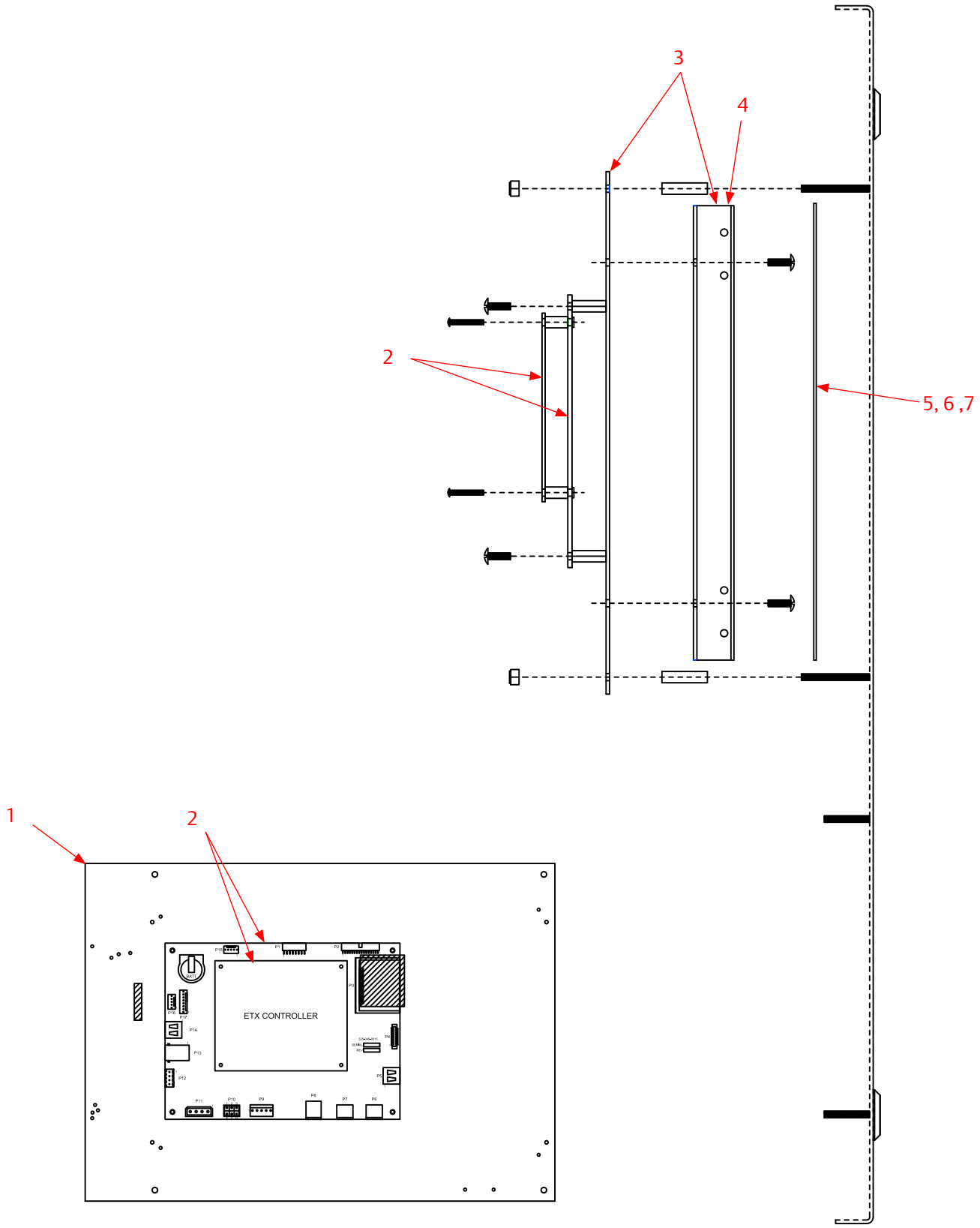

Figure 27-3. Vision 20/20 - SBC Assembly

## Section 27 • Parts

---

### Vission 20/20 - SBC Assembly

Item No.	Description	VPN
1.1	SBC ASSEMBLY W/FLASHCARD, LINUX OS, 15"XGA INDOOR DISPLAY, INVERTOR BOARD, ATOM CPU, BASEBOARD, MEMORY CARD.	3485MLA
1.2	SBC ASSEMBLY W/FLASHCARD, LINUX OS, 15"XGA OUTDOOR DISPLAY, INVERTOR BOARD, ATOM CPU, BASEBOARD, MEMORY CARD.	3485MLQA
2	.ATOM CPU ASSEMBLY, BASEBOARD, MEMORY CARD	3485MCA
3.1	.DISPLAY ASSEMBLY (LESS CPU BOARD), 15"XGA INDOOR DISPLAY, MOUNTING PLATE, INVERTER BOARD, DISPLAY AND INVERTER HARNESSSES.	3485MDA
3.2	.DISPLAY ASSEMBLY (LESS CPU BOARD), 15"XGA OUTDOOR DISPLAY, MOUNTING PLATE, INVERTER BOARD, DISPLAY AND INVERTER HARNESSSES.	3485MDQA
4.1	..DISPLAY BACKLIGHT (INDOOR)	3485DLD
4.2	..DISPLAY BACKLIGHT (OUTDOOR)	3485DLQ
5	.REPAIRED RESISTIVE TOUCHSCREEN, 15" 8 WIRE DAWAR	3485JR
6	.RESISTIVE TOUCHSCREEN, 15" 8 WIRE DAWAR	3485J
7	.TAPE TO SECURE TOUCHSCREEN TO DOOR	3485JT

# Appendix A • Vission 20/20 Troubleshooting Guide

## Vission 20/20 Troubleshooting Guide

In the event of a problem with the Vilter™ Vission 20/20™, the help screen, along with your electrical drawings will help determine the cause.

### NOTICE

Before applying power to the Vission 20/20 control panel, all wiring to the panel should be done per the National electrical Code (NEC). Specifically check for the proper voltage and for the neutral to be grounded at the source. An equipment ground should also be run to the panel.

Table A. Vission 20/20 Troubleshooting Guide (1 of 3)

Problem	Solution
Vission 20/20 does not boot up, no lights in any of the boards	Check that 120VAC is run to circuit breaker CB1 located on the terminal strip. The neutral should be brought to any “N” terminal on the terminal strip.
	Check that circuit breaker CB1’s switch is in the ON position.
	Use a voltmeter to insure 120VAC is being applied to the power supply, located on the door. If all of the above are OK, the power supply may be bad. To test the power supply, check DC voltages at the power supply output. If proper voltages are not found at these test points, the power supply may be faulty.
Vission 20/20 appears to have booted, lights are lit on the boards, but no touchscreen display is evident	Remove power COMPLETELY from the Vission 20/20 and restart the controller.  <p style="text-align: center;"><b>WARNING</b></p> The inverter board creates a high rms voltage to drive the backlight - it can exceed 1500VAC. Use extreme caution and insure that voltage has been removed from the board before physical inspection. Visually check cable connections located on the LCD inverter board. This board is located inside the door on the LCD touch screen back pane next to the single board computer. Physically inspect board to insure that all cable connectors are connected tightly to the board connectors. If these are inserted correctly, the problem could be a bad LCD inverter board or a component failure.
	Check the flash card’s socket

Table A. Vission 20/20 Troubleshooting Guide (2 of 3)

Problem	Solution
The panel is taking a long time to boot and start, sometimes doesn't start at all	See solutions for "Vission 20/20 does not boot up, no lights in any of the boards"
	Check the flash card's socket
	Check the battery's main board socket
Blue or white screen at boot up	Check the I/O board cable connectors
	Reboot the 20/20
The screen is black	Change the flashcard (part number 3485FC)*
	Reboot the 20/20
	Check the 5 and 12 VDC. If the wrong voltage is detected, adjust the potentiometer. If this doesn't fix the problem, replace it. The part number of the power supply is 3485K
If the touchscreen is indeed bad, replace it with part number 3485J	
The screen is unresponsive or slow to touch	If it's slow, make sure the Trending graph is turned off.
The on-screen cursor doesn't follow the user's finger	Recalibrate the touchscreen, go to Configuration page 2, click on the Calibrate button. The calibration mode requires the operator to touch the four corners of the touchscreen and then the accept button.
Vission 20/20 boots up but all data temperatures and pressures are zeroed and do not update.	Check analog board jumpers to make sure proper node addresses are set up on all boards. Physically inspect power and communication jumper cables to make sure they are inserted properly and completely. Two LEDs on all boards show the status of the communications for the board. LED1 is on when a command is received at the board from the single board computer (SBC), and LED2 is on when a response is sent from the board to the SBC.

Table A. Vission 20/20 Troubleshooting Guide (3 of 3)

Problem	Solution
I/O COMM Trip	Check that the digital and analog boards are selected on Page 6 of the Configuration screen.
	Check that the dipswitches are correctly closed on the board. Open and close them to make sure they are making contact.
	Check that cables are snug on the boards
	Check the “Event List” to see which board is coming up as non-responsive, and replace it
I can’t login with the ADMIN username	Use the Vilter™ App to create a new temporary password. You will need the serial number and date from the “Version” screen (inside the Help screen). The user name for the temporary password is Vilter
An option within configuration cannot be selected	Check Configuration page 6 to see if the board that this option belongs to is selected. Also, make sure that the board is actually installed.
Corrupted program	Write down your settings, or make sure you have created a .csv file with them. Go to “Data Backup” and choose “Migrate/Reset”. After the factory reset you can re-enter/load your settings.
The control method being used is not working.	Go to Configuration page 1 and make sure the correct method is selected in the “Active Remote Control” box
The date goes back to 1/1/2002 when the panel reboots	The 5V DC battery on the processor is not connecting properly to the socket handle. Remove the battery and pull out the handle in the socket so the battery fits snugly .
The compressor doesn’t start, even if the pressure is above the setpoint	There’s an active trip. Read the screen
	Setpoint 2 is active, and setpoint 1 is not.
	The slides’ position is above 5%. Check the actuator to make sure there isn’t an active alarm on it
Capacity or volume on-screen values are above 100 % or below 0 %	The slides moved beyond the software limits. Recalibrate the slides

## Contents

Vission 20/20 Compressor Control Setup .....	B-3
Vission 20/20 Compressor Control Setpoints Setup.....	B-6
Vission 20/20 Compressor Sequencing Setup.....	B-14
Danfoss Liquid Injection Valve Setup .....	B-22
Phoenix Contact PSM-ME-RS485/RS485-P Isolator.....	B-23
Vessel Level Control Setup for Vission 20/20 Control Panel .....	B-25
VPLUS (AC Motor) Setup Procedure for Vission 20/20 Panel .....	B-33
VPLUS (DC Motor) Setup Procedure for Vission 20/20 Panel .....	B-39
Vibration Monitoring Setup Procedure.....	B-46





## Appendix B • Vission 20/20 Application Procedures

---

### Vission 20/20 Compressor Control Setup

#### SCOPE

Vission 20/20 programs – version 1.6.4550.1 and later.

#### PULLDOWN

The Pulldown feature provides a method to slowly pull down the suction pressure from a high value, by slowly lowering the suction pressure control setpoint over a time period. This feature is sometimes required on systems that have liquid recirculation systems. On these systems, if the suction pressure is pulled down too fast, the pumps can cavitate causing vibration and damage to the pumps. By slowly lowering the suction pressure setpoint the suction pressure can be slowly lowered preventing liquid recirculation pump cavitation. Pulldown is also to be used for new plant startups. Pulling the suction pressure (and resultant temperature) of new buildings down too quickly can cause structural damage, so limiting the suction pressure Pulldown rate will prevent this, allowing time to de-humidify the rooms as the temperature in the rooms is pulled down.

Pulldown can only be activated when controlling in Suction Pressure Control mode (Setpoint #1).

#### NOTE

In new plant construction Pulldown applications, water freezing in the concrete will lead to structural damage. For new plant construction Pulldown applications, it is highly recommended that the Auto-Cycle be enabled while running Pulldown. During Pulldown, when the Suction Pressure Control setpoint is slowly lowered, the Auto-Cycle Start and Stop setpoints are also slowly lowered. The Auto-Cycle Stop setpoint will turn the compressor off should the suction pressure fall too fast. For additional safety, the Low Suction Pressure Alarm and Trip setpoints should also be set so that the suction pressure will not reach a point that can cause building damage due to water freeze.

#### SETUP

The Pulldown section in the Compressor Control Menu provides the options to be selected for the Pulldown feature, see Figure B-1.

#### Pulldown

- Enables access to Pulldown control setpoints. Uncheck the box to disable the Pulldown setpoints.

Initiate Pulldown at Next Start

- Enables the Pulldown feature when the compressor starts

Initiate Pulldown at Every Start

- Enables the Pulldown feature on every compressor start.

Step Pressure

- Step pressure defines the “steps” (in psig) in which the suction pressure setpoint is decreased.

Delay Per Step

- Delay per Step setting which defines how long the compressor will be controlled at the current suction pressure setpoint, in hours and minutes. Minimum range of 1, maximum of 1259.

Stop Pressure

- Pressure at which the Pulldown feature is deactivated. After Pulldown has completed, the suction pressure setpoint will remain at this setting and the compressor will continue to control at this pressure.

Auto-cycle Differential

- This setpoint defines a differential above and below the suction pressure control setpoint. These points define the auto-cycle start and stop pressure setpoints. The auto-cycle Start pressure is the suction pressure setpoint + auto-cycle differential setpoint. The Auto-cycle Stop pressure is the suction pressure setpoint - auto-cycle differential setpoints.

# Appendix B • Vission 20/20 Application Procedures

Figure B-1. Pulldown Setpoints

## SETPOINT SELECTION EXAMPLE

The following example is to illustrate the selection of setpoints for the Pulldown feature. The values picked are NOT representative of actual field applications.

Assumptions and Variables:

- Current suction pressure is at 80 psig
- Target suction pressure is 20 psig. (This defines a change of 60 psig).
- Time duration allowed to get to setpoint is 10 days (240 hours) of Pulldown time.
- Suction pressure change allowed for each step is 5 psig.

To calculate the Delay Per Step setpoint:

$$\text{Number of Pulldown Steps} = \text{Delta 60 psig change} * 1 \text{ step}/5 \text{ psig} = 12 \text{ steps}$$

$$\text{Delay per step} = 240 \text{ hours} / 12 \text{ steps} = 20 \text{ hours/step}$$

So, for the first 20 hours the compressor runs at 75 psig, then for the next 20 hours at 70 psig, then for the next 20 hours at 65 psig, and so forth.

After the 12th step (running at 25 psig), 240 hours will have elapsed, and the new setpoint changes to 20 psig. After the Pulldown setpoint equals or is less than the control setpoint, the Pulldown feature disables itself.

## Appendix B • Vission 20/20 Application Procedures

---

### PULLDOWN OPERATION EXAMPLE

Assumptions:

- Compressor is off
- Pulldown is selected
- “Initiate Pulldown at Next Start” is selected
- Current suction pressure = 80 PSIG
- Auto-cycle setpoints are enabled
- Pulldown setpoints are setup per the Setpoint Selection Example

Variables:

- Step Pressure = 5.0 PSIG
- Delay Per Step = 20 hours
- Stop Pressure = 20 PSIG
- Auto-cycle Differential = 4 PSIG

Operator presses Unit Start Auto button and the compressor starts. Two items occur:

- The Pulldown feature is now operational
  - When Pulldown feature is active:
    - Pumpdown is disabled (Pulldown and Pumpdown operation modes are mutually exclusive)
    - Low Suction Pressure Stop Load and Unload setpoints are active (Make sure that these setpoints do not conflict with the Pulldown Stop setpoint)
- The Pulldown setpoints are immediately calculated:

Initial Pulldown setpoint = Current Suction Pressure 80 psig minus Step Pressure (5 psig) = 75 psig

Auto-Cycle Start Pressure = Pulldown setpoint (75 psig) plus Auto-Cycle Differential (4 psig) = 79 psig

Auto-cycle Stop Pressure = Pulldown setpoint (75 psig) minus Auto-Cycle Differential (4 psig) = 71 psig

The compressor will maintain the suction pressure at 75 psig for the first 20 hours, and then the next calculation of Pulldown setpoints will be made:

Subsequent Pulldown setpoint = Suction Pressure setpoint (75 psig) minus Step Pressure (5 psig) = 70 psig.

Auto-Cycle Start Pressure = Pulldown Setpoint (70psig) plus Auto-Cycle Differential (4 psig) = 74 psig

Auto-Cycle Stop Pressure = Pulldown Setpoint (70 psig) minus Auto-Cycle Differential (4 psig) = 66 psig

After 20 hours of running at 70 psig, the next set of Pulldown setpoints are calculated. This is repeated until the target setpoint (Stop Pressure setpoint) is reached. The Pulldown operation is then disabled and the compressor will continue to operate at this setpoint.

# Appendix B • Vission 20/20 Application Procedures

## Vission 20/20 Compressor Control Setpoints Setup

### SCOPE

Vission 20/20 programs – version 1.6.4550.1 and later

### COMPRESSOR SETPOINT #1 AND SETPOINT #2

The Vission 20/20 allows for multiple control setpoints. This can be utilized for nighttime or weekend setpoint adjustment in cold storage facilities or when a compressor is being used in a swing application, where it swings between booster and high stage operation. Setpoint 1 can be setup to operate as a booster compressor and Setpoint 2 can be setup to operate the compressor to meet the high stage setpoint.

### SETUP

The configuration screen must first be setup to enable two setpoints, see Figure B-2.

To enable the two setpoint operation, do the following:

- In the section “Compressor Control”, enter “2” for each control in the “# Controllers” box.

### COMPRESSOR CONTROL SETPOINTS

Navigate to the Compressor Control screen and enter in the desired control setpoints for both Setpoint 1 and Setpoint 2.

Log in to set up both Setpoint 1 and Setpoint 2 as shown in Figure B-3. The load and unloading response of the compressor for both setpoints can also be changed. This will be useful when the compressor is operating between a high stage and booster application.

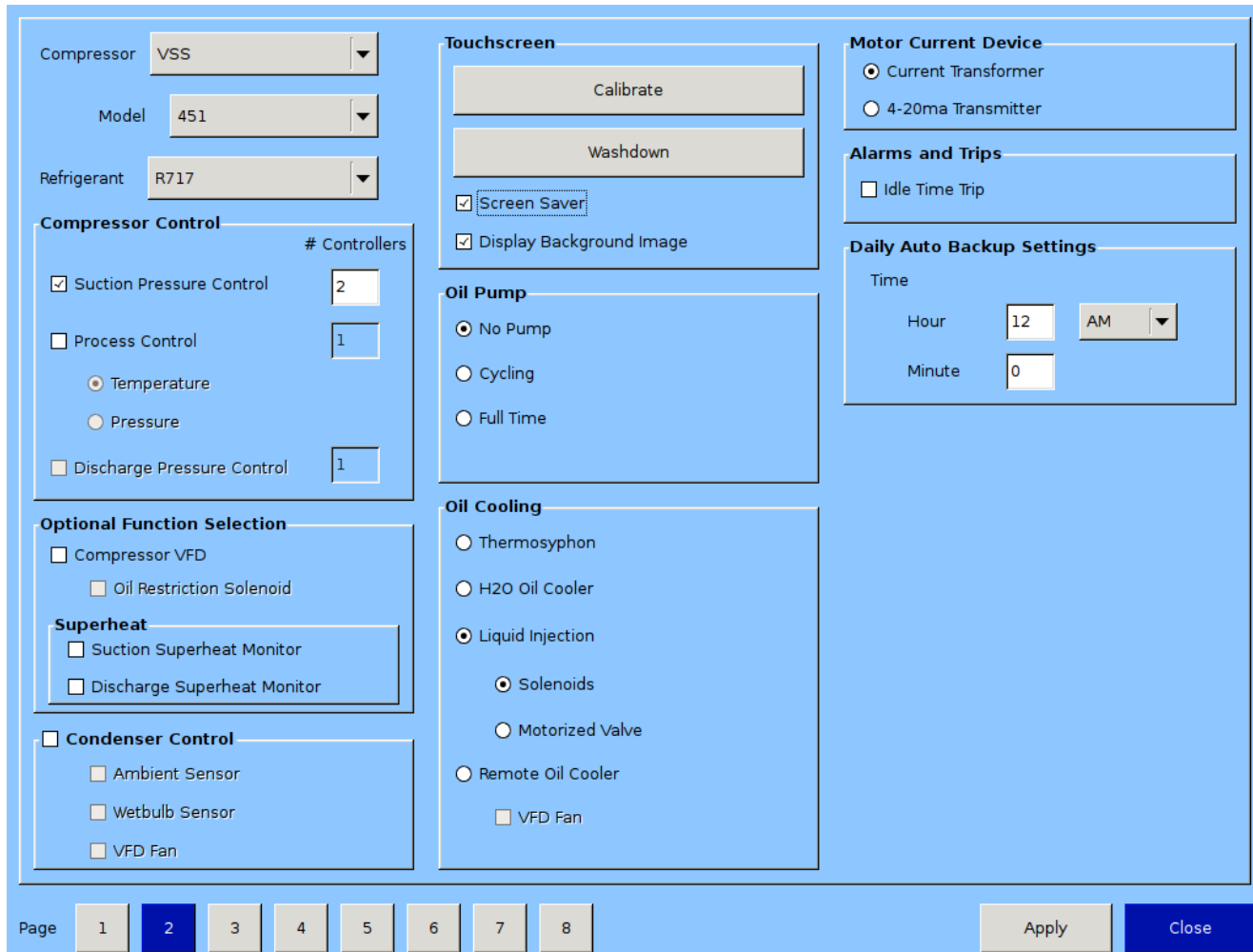

Figure B-2. Configuration Screen (Page 2) - Two Setpoint Operation Setup

# Appendix B • Vision 20/20 Application Procedures

Process Control 1
Stopped
122.9 Psig Δ

Setpoint
Setpoint 1
Setpoint 2

Pressure Control Setpoint	30.0 Psig	30.0 Psig		
Capacity Increase				
Interval / Pulse Time	4.0 sec	4.0 sec	4.0 sec	4.0 sec
Proportional / Dead Band	4.0 Psig	10.0 %	4.0 Psig	10.0 %
Capacity Decrease				
Interval / Pulse Time	4.0 sec	4.0 sec	4.0 sec	4.0 sec
Proportional / Dead Band	4.0 Psig	10.0 %	4.0 Psig	10.0 %

**Auto-cycle**

 Enable
 

Start Pressure	28.0 Psig	38.0 Psig		
Start Delay	5 sec	5 sec		
Stop Pressure	16.0 Psig	26.0 Psig		
Stop Delay	5 sec	5 sec		
Min Slide Position	10 %	10 %		

Capacity Slide

0.1 %

-    +

Volume Slide

0.0 %

Stop

Remote Lock Out

Alarm Reset

Unit Start

**Process Press Control**

Setpoint 30.0 Psig

**Suction**

Press 43.6 Psig

Temp 26.2 °F

**Discharge**

Press 177.4 Psig

Temp -3.9 °F

**Discharge : Suction**

Press Ratio 3.3

**Oil**

Press Diff 118.8 Psig

Filter Diff 5.7 Psig

Inj Temp 78.6 °F

Sep Temp 191.2 °F

**Motor**

Amperage 0.0 Amps

Page 1 2 3 4 5 6 Menu

Maintenance
User Access
Log off
Help

No Scheduled Maintenance

No Alarm/Trips Present

User admin

07/15/2015 11:44:13

Run Hours 0

Figure B-3. Compressor Control Setpoint 1 and Setpoint 2 Setup

# Appendix B • Vission 20/20 Application Procedures

## CONTROL MODE DROP-DOWN BOX

In Figure B-4, the Control Mode drop-down box allows selection of the active setpoints.

To change from Setpoint 1 to Setpoint 2 being the active setpoint, do the following:

- Select the Control Mode drop-down box, and then select Setpoint 2.
  - This can be done when the compressor is off or running.

### CAUTION

Please be aware that changing the active setpoint while the compressor is running could end up shutting the compressor off. A control setting (i.e. Auto-Cycle Stop setpoint or Low Suction Pressure trip setpoint) may shut the compressor down as soon as you make the switch depending upon the setting of the new active setpoint.

## SAFETY SETPOINTS

In Figure B-5, the Alarm and Trip Safety setpoints also have Setpoint 1 and Setpoint 2 settings. These should be set up for proper operation when operating.

## DIRECT I/O OPERATION AND SETPOINT 1 AND SETPOINT 2 SELECTION

If the compressor is being operated in Direct I/O mode, then the selection of the active setpoint is accomplished from an input module. Reference the wiring diagram to identify the module. The Setpoint 1 / Setpoint 2 selection module will be recognized when the compressor is placed in REMOTE mode (by pressing the Unit Start button and then the Remote button). When the input module is energized, then Setpoint 2 is active. De-energizing the module places the Vission 20/20 control panel into Setpoint 1 mode.

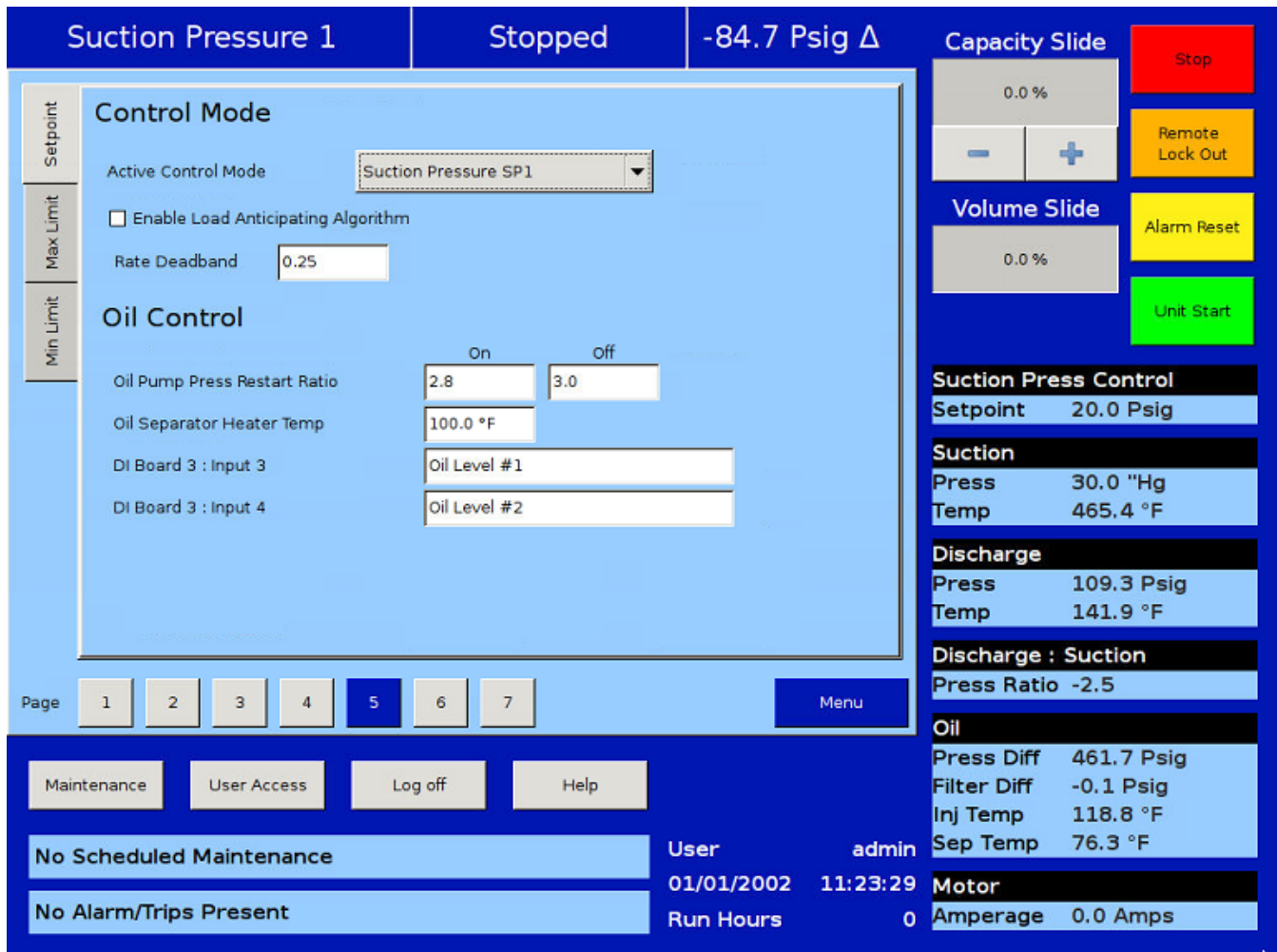

Figure B-4. Control Mode and Oil Control

# Appendix B • Vission 20/20 Application Procedures

## SERIAL OR ETHERNET OPERATION AND SETPOINT 1 AND SETPOINT 2 SELECTION

Refer to Figure B-4, for registering information to set up the active setpoint.

The screenshot displays the Vission 20/20 application interface. At the top, it shows 'Suction Pressure 2', 'Stopped', and '-94.7 Psig Δ'. The main area is divided into sections for 'Alarm' and 'Trip' setpoints for four different pressure types: Low Suction Pressure, High Discharge Pressure, Low Process Pressure, and High Process Pressure. Each section has two setpoint numbers with corresponding values in 'Hg' or 'Psig'.

	Alarm	Trip
<b>Low Suction Pressure</b>		
Setpoint No. 1	3.1 "Hg	4.1 "Hg
Setpoint No. 2	1.0 "Hg	2.0 "Hg
<b>High Discharge Pressure</b>		
Setpoint No. 1	210.0 Psig	220.0 Psig
Setpoint No. 2	220.0 Psig	230.0 Psig
<b>Low Process Pressure</b>		
Setpoint No. 1	3.1 "Hg	4.1 "Hg
Setpoint No. 2	1.0 "Hg	2.0 "Hg
<b>High Process Pressure</b>		
Setpoint No. 1	210.0 Psig	220.0 Psig
Setpoint No. 2	220.0 Psig	230.0 Psig

On the right side, there are control elements: 'Capacity Slide' at 0.0%, 'Volume Slide' at 0.0%, and buttons for 'Stop', 'Remote Lock Out', 'Alarm Reset', and 'Unit Start'. Below these are status indicators for 'Suction Press Control' (Setpoint 30.0 Psig), 'Suction' (Press 30.0 "Hg, Temp 465.2 °F), 'Discharge' (Press 109.0 Psig, Temp 141.4 °F), 'Discharge : Suction' (Press Ratio -2.5), and 'Oil' (Press Diff 461.3 Psig, Filter Diff -0.3 Psig, Inj Temp 118.8 °F, Sep Temp 76.0 °F). At the bottom, there are buttons for 'Maintenance', 'User Access', 'Log off', and 'Help', along with status messages like 'No Scheduled Maintenance' and 'No Alarm/Trips Present', and user information: 'User admin', '01/01/2002 11:49:35', and 'Run Hours 0'.

Figure B-5. Alarm and Trip Safety Setpoints for Setpoint 1 and Setpoint 2



## Appendix B • Vission 20/20 Application Procedures

---

### CONTINUOUS VI EXAMPLE

Refer to Figure B-4, for registering information to set up the active setpoint.

Setup:

Compressor - VRS

Refrigerant – R717

Suction Pressure Control Setpoint = 2 psig

VI Control Method - Continuous VI

Time Interval = 20 sec

Min VI = 2.2 (0%)

Max VI = 5.0 (100%)

Deadband = 0.4

Capacity Min Limit = 150mV

Capacity Max Limit (Max VI) = 3910mV

Capacity Max Limit (Min VI) = 4850mV

Start Compressor in Auto Run Mode.

Discharge Pressure = 160 Psig

Scenario 1:

Adjust Suction Pressure = 54 Psig

Calc VR= 2.0

Capacity = 100% (4850mV)

Volume = 0%

Scenario 2:

Adjust Suction Pressure = 40 psig

Calc VR = 2.5

Capacity = 100% (4850mV)

Volume = 0%

Scenario 3:

Adjust Suction Pressure = 35 psig

Calc VR: 2.7

Capacity = 100% (4682.14mV)

Volume = 17.85%

Scenario 4:

Adjust Suction Pressure = 26 psig

Calc VR: 3.2

Capacity = 100% (4514.28mV)

Volume = 35.71%

Scenario 5:

Adjust Suction Pressure = 18 psig

Calc VR: 3.6

Capacity = 100% (4380.00mV)

Volume = 50%

Scenario 6:

Adjust Suction Pressure = 13 psig

Calc VR: 4.2

Capacity = 100% (4178.57mV)

Volume = 71.42%

Scenario 7:

Adjust Suction Pressure = 7 psig

Calc VR: 5.0

Capacity: 100% (3910.00mV)

Volume = 100.00%

Scenario 8:

Suction Pressure = 9 psig

Calc VR: 4.7

Volume = 100.00%

Capacity: 100% (3910.00mV)

Scenario 9:

Suction Pressure = 10 psig

Calc VR: 4.6

Volume = 85.71%

Capacity: 100% (4060.00mV)

Scenario 10:

Suction Pressure = 29 psig

Calc VR: 2.9

Volume = 25.00%

Capacity: 100% (4602.00mV)



## Appendix B • Vission 20/20 Application Procedures

---

Scenario 11:

Suction Pressure = 54 Psig

Calc VR= 2.0

Volume = 0%

Capacity = 100% (4850mV)

### STEP VI EXAMPLE

Setup:

Compressor - VRS

Refrigerent – R717

Suction Pressure Control Setpoint = 2 psig

VI Control Method - Step VI

Time Interval = 20 sec

Step 1 = 2.2

Step 2 = 3.5

Step 3 = 5.0

Capacity Min Limit = 150mV

Capacity Step 3 Max Limit = 3440mV

Capacity Step 2 Max Limit = 4145mV

Capacity Step 1 Max Limit = 4850mV

In this example the average of Step 1 and Step 2 will be 2.85 and the average of Step 2 and Step 3 will be 4.25. So the VI values from 2.2 to 2.85 will be considered as Step 1 VI, from 2.86 to 4.25 as Step 2 and more than 4.25 will be considered as Step 3. The step for step VI will not change till the VI value does not go beyond the average of two steps. There is hysteresis of 0.1.

Start Compressor in Auto Run Mode.

Discharge Pressure = 160 Psig

Scenario 1:

Adjust Suction Pressure = 54 Psig

Calc VR= 2.0

Capacity = 100% (4850mV)

Low VI Digital Output = ON

High VI Digital Output = OFF

Scenario 2:

Adjust Suction Pressure = 29 Psig

Calc VR= 2.9

Capacity = 100% (4850mV)

Low VI Digital Output = ON

High VI Digital Output = OFF

Scenario 3:

Adjust Suction Pressure = 28 Psig

Calc VR= 3.0

Capacity = 100% (4145mV)

Low VI Digital Output = OFF

High VI Digital Output = ON

Scenario 4:

Adjust Suction Pressure = 12 Psig

Calc VR= 4.3

Capacity = 100% (4145mV)

Low VI Digital Output = OFF

High VI Digital Output = ON

Scenario 5:

Adjust Suction Pressure = 11 Psig

Calc VR= 4.4

Capacity = 100% (3440mV)

Low VI Digital Output = OFF

High VI Digital Output = OFF

Scenario 6:

Adjust Suction Pressure = 7 Psig

Calc VR= 5.0

Capacity = 100% (3440mV)

Low VI Digital Output = OFF

High VI Digital Output = OFF

Scenario 7:

Adjust Suction Pressure = 13 Psig

Calc VR= 4.2

Capacity = 100% (3440mV)

Low VI Digital Output = OFF

High VI Digital Output = OFF

Scenario 8:

Adjust Suction Pressure = 14 Psig

Calc VR= 4.1

Low VI Digital Output = OFF

High VI Digital Output = ON

Capacity = 100% (4145mV)

## Appendix B • Vission 20/20 Application Procedures

Scenario 9:

Adjust Suction Pressure = 31 Psig

Calc VR= 2.8

Low VI Digital Output = OFF

High VI Digital Output = ON

Capacity = 100% (4145mV)

Scenario 10:

Adjust Suction Pressure = 34 Psig

Calc VR= 2.7

Low VI Digital Output = ON

High VI Digital Output = OFF

Capacity = 100% (4850mV)

Scenario 11:

Adjust Suction Pressure = 50 Psig

Calc VR= 2.2

Low VI Digital Output = ON

High VI Digital Output = OFF

Capacity = 100% (4850mV)

Hence we can see that:

- When VI Control is in Step 1 then VI step will not get changed to Step 2 until the VI value goes beyond 2.95 (2.85 + 0.1).
- When VI Control is in Step 2 then VI step will not get changed to Step 1 until the VI value drops to 2.75 (2.85 - 0.1).
- When VI Control is in Step 2 then VI step will not get changed to Step 3 until the VI value goes beyond 4.35 (4.25 + 0.1).
- When VI Control is in Step 3 then VI step will not get changed to Step 2 until the VI value drops to 4.15 (4.25 - 0.1)

Notes on Step VI Digital Outputs :

- To position the volume slide – we need to use the two outputs designated for volume slide control for the single screw compressors – Digital Output board #1, outputs #5 and #6.
- As per Table B-1, we need SV3 and SV4 ON at the same time to position the slide at 2.2 vi position.

The table below shows the required states of the solenoids.

**Table B-1. Solenoid States Required For Positioning Volume Slide**

	Vol Ratio 2.2	Vol Ratio 3.5	Vol Ratio 5.0
(SV3)	ON	OFF	OFF
(SV4)	ON	ON	OFF

The program of the digital output board #1 on the 20/20 doesn't allow the volume "increase" and the volume "decrease" outputs (outputs #5 & #6) to be on at the same time. The program was written this way to protect the actuator motor on the single screw compressors.

So on the Twin Screw Compressors with 3 - Step VI Control, the above output states are achieved by redefining the Output states of #5 and #6 at Vol Ratio 2.2, and then use relay logic to achieve the required solenoid states.

**Table B-2. Solenoid States Required For Positioning Volume Slide**

	Vol Ratio 2.2	Vol Ratio 3.5	Vol Ratio 5.0
Output #5 (CR5)	ON	OFF	OFF
Output #6 (CR6)	OFF	ON	OFF

Then, using relay logic, see Figure B-5A – wire the solenoids so that the states of the relays in Table B-2 will translate the states of the solenoids to match Table B-1.

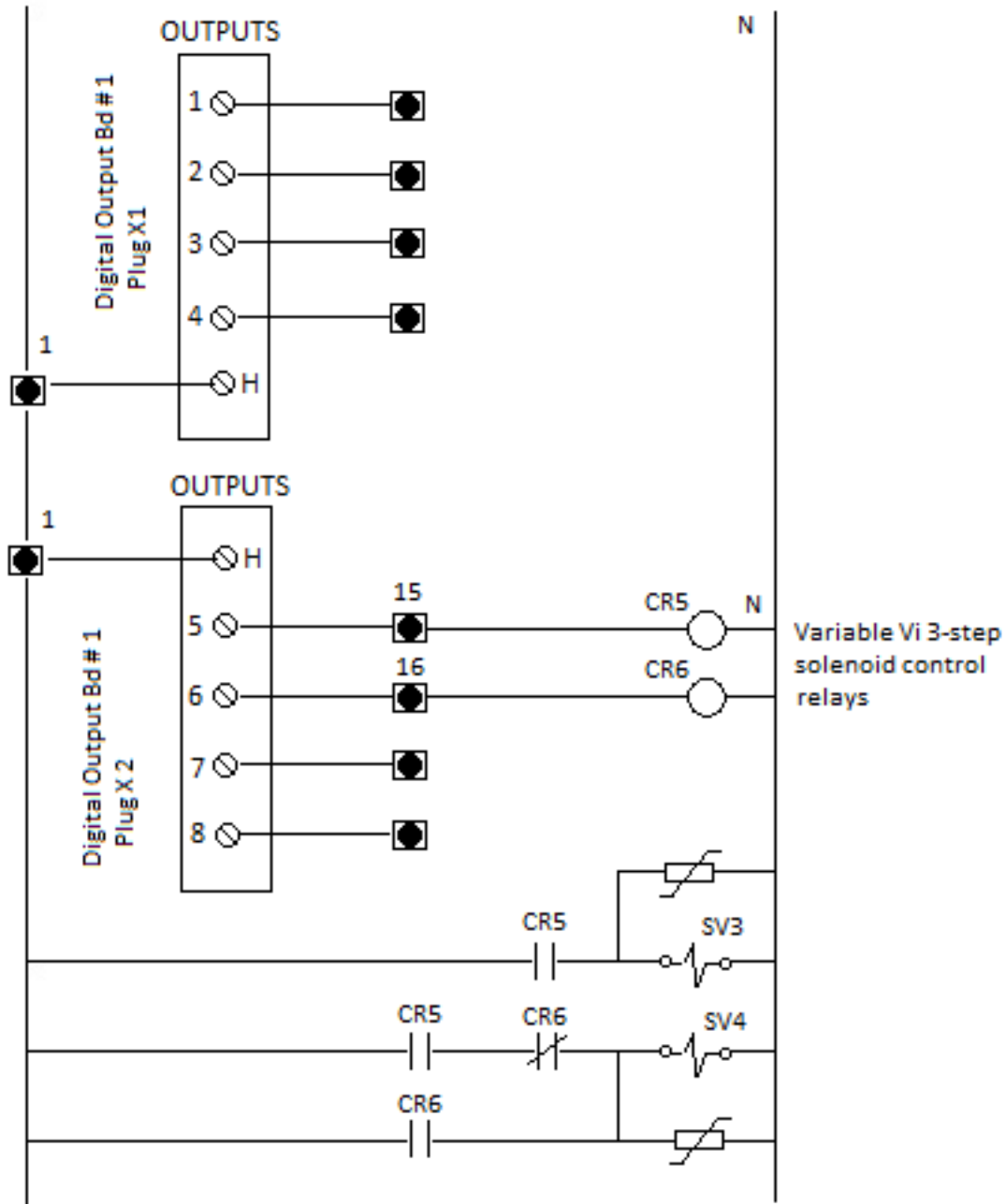

Figure B-5A. Required Relay Logic / Wiring to Achieve Table B-1 Solenoid States

# Appendix B • Vission 20/20 Application Procedures

## Vission 20/20 Compressor Sequencing Setup

### SCOPE

Vission 20/20 programs – version 1.6.4550.1 and later.

### OVERVIEW

Compressor sequencing in the Vission 20/20 panel is carried out by utilizing the Ethernet communication port using Modbus TCP protocol.

Compressor sequencing is accomplished by the master compressor, monitoring its own control parameter (either suction pressure, process temperature or discharge pressure). As its control parameter changes value, it will make decisions to start, stop, load and unload slave compressors as needed, to maintain the control setpoint which is defined in the master compressor sequencing screen.

compressor – and act as the trim compressor. So this must be taken into account when deciding which compressor is to act as the master compressor.

The following discussion assumes that the physical Ethernet Network has been installed between all Vission 20/20 control panels.

### NOTE

The master compressor will ALWAYS be priority #1

The screenshot displays the 'Suction Pressure Control' and 'Auto-cycle' configuration screens. The top status bar shows 'Suction Pressure 1', 'Stopped', and '6.6 Psig Δ'. The 'Suction Pressure Control' section includes two setpoints: Setpoint 1 (20.0 Psig) and Setpoint 2 (30.0 Psig). It also defines capacity increase and decrease parameters with interval/pulse times and proportional/dead band settings. The 'Auto-cycle' section has an 'Enable' checkbox and defines start/stop pressures and delays for two setpoints. The right sidebar contains 'Capacity Slide' (0.0%), 'Volume Slide' (0.0%), and control buttons like 'Stop', 'Remote Lock Out', 'Alarm Reset', and 'Unit Start'. The bottom status area shows 'Suction Press Control' (Setpoint 20.0 Psig), 'Suction' (Press 26.6 Psig, Temp 54.6 °F), 'Discharge' (Press 123.8 Psig, Temp 71.5 °F), 'Discharge : Suction' (Press Ratio 3.4), 'Oil' (Press Diff 143.7 Psig, Filter Diff 9.5 Psig, Inj Temp 115.3 °F, Sep Temp 110.5 °F), and 'Motor' (Amperage 0.0 Amps). The bottom navigation bar includes 'Maintenance', 'User Access', 'Log off', 'Help', 'Panel 1', 'User admin', '11/07/2014 10:41:33', 'Run Hours 0', 'No Scheduled Maintenance', and 'No Alarm/Trips Present'.

Figure B-6. Master Compressor Loading, Unloading and Auto-cycle Setpoints Setup

# Appendix B • Vission 20/20 Application Procedures

## CONFIGURATION OVERVIEW

### MASTER COMPRESSOR CONTROL SETPOINTS SETUP

Navigate to the Compressor Control menu of the Master Compressor – page 1, see Figure B-6. The “Pressure Control Setpoint” setting defines the control setpoint for the entire sequencing system. The capacity increase and capacity decrease proportional control settings define the loading and unloading settings for the master compressor ONLY. (The slave compressor(s) load and unloading is setup in the master compressor sequencing menu). The Auto-cycle settings can also be setup for the Master Compressor, to establish settings of when the Master compressor will automatically cycle on and off.

#### NOTE

The proportional control settings affect the loading and unloading of the master compressor only. The slave compressor loading and unloading rules are

defined in the Compressor Sequencing screen of the master compressor. Also, during slave compressor sequencing, the Auto-cycle setpoints are not active for the slave compressors, even if Auto-cycle has been selected. However, it may still be desirable to check the Auto-cycle setpoints for the slave compressors. This can be desirable if the Master Compressor panel is powered down, and the slave compressors then revert to “Local” control. When the panels revert to “Local” control, then the Auto-cycle setpoints would become active.

### SETUP OF MASTER COMPRESSOR FOR SEQUENCING SLAVE COMPRESSORS

Logon to the Master Compressor and navigate to the Compressor Sequencing screen, page 1, see Figure B-7. Slaves can be setup for sequencing from the Equipment List. Options under the Equipment List are populated depending on devices shown in the Device List Screen of the Compressor Sequencing Menu.

The screenshot displays the Master Compressor Control interface. At the top, it shows 'Suction Pressure 1', 'Stopped' status, and '6.0 Psig Δ'. The main area is divided into several sections:

- Master Compressor Settings:** Device Name: Master, Min Trigger: 70%, Max Trigger: 85%.
- Equipment List Table:**

Equipment	Control	Priority	Step	Min Cap	Max Cap	Status
Slave 1	ON	1	10%	10%	95%	✓
Slave 2	ON	2	10%	10%	95%	✓
Slave 3	ON	3	10%	10%	95%	✓
None	OFF	4	10%	10%	95%	—
None	OFF	5	10%	10%	95%	—
None	OFF	6	10%	10%	95%	—
None	OFF	7	10%	10%	95%	—
None	OFF	8	10%	10%	95%	—
None	OFF	9	10%	10%	95%	—
- Machine Timers:** Start Time: 90 sec, Stop Time: 90 sec, Accelerated Shut Down Timer: 60 sec.
- Capacity Slide:** 0.0% (with Stop, Remote Lock Out, and Alarm Reset buttons).
- Volume Slide:** 0.0% (with Unit Start button).
- Suction Press Control:** Setpoint: 20.0 Psig.
- Suction:** Press: 26.0 Psig, Temp: 54.8 °F.
- Discharge:** Press: 128.4 Psig, Temp: 71.2 °F.
- Discharge : Suction:** Press Ratio: 3.5.
- Oil:** Press Diff: 144.5 Psig, Filter Diff: 9.4 Psig, Inj Temp: 113.7 °F, Sep Temp: 109.6 °F.
- Motor:** Amperage: 0.0 Amps.

At the bottom, there are navigation buttons (Page 1-6, Menu), user access controls (Maintenance, User Access, Log off, Help), and system status (No Scheduled Maintenance, No Alarm/Trips Present). The user is identified as 'Master admin' with a login time of 11/07/2014 18:21:05 and 0 Run Hours.

Figure B-7. Setup of Master Compressor for Slave Compressor(s) Loading and Unloading

## Appendix B • Vision 20/20 Application Procedures

### MASTER COMPRESSOR SEQUENCING MENU SETUP

The master compressor loads and unloads itself based on the proportional control settings that are set in its own Compressor Control Setpoints menu. The Auto-cycle Setpoints can also be enabled for the master compressor, which would define the setpoints for when the master compressor will stop and start. Auto-cycle settings on the slaves are not active during sequencing; however you still may wish to select Auto-cycle on the slave compressor for the circumstance where the power is removed from the Master panel, and the slave compressors would then revert to “Local” control.

The master compressor controls the slave compressors based on the master compressor control setpoints as well as the setpoints entered in the master compressor sequencing menu. Page 2 of the master compressor sequencing menu (see Figure B-8) allows the operator to view and adjust settings which are used for compressor sequencing. The pressure / temperature control setpoints and capacity load / unload timers to accomplish sequencing control are defined here:

1. Start Offset
2. Suction Pressure / Process Temperature / Discharge Pressure Control Setpoint
3. Fast Load Offset
4. Fast Unload Offset

#### Start Offset

- Defines the offset from pressure/temperature control setpoint to start a slave compressor. If suction pressure / process temperature surpasses the start offset setpoint and master compressor capacity has reached the max trigger setpoint then the sequencing algorithm allows the starting and loading of the slave compressors to cater to increasing load requirements.

#### Suction Pressure / Process Temperature / Discharge Pressure Control Setpoint

- The target setpoints are read-only values here. These setpoints can be changed by logging on

The screenshot displays the 'Master Compressor Sequencing Menu Setup' interface. At the top, it shows 'Suction Pressure 1', 'Stopped', and '6.1 Psig Δ'. The main control area is titled 'Suction Pressure Control Setpoints' and features a blue arrow pointing left labeled 'Unload Rate' and a red arrow pointing right labeled 'Load Rate'. Below these are four control panels: 'Fast Unload' (Pressure Offset: 4.0 Psig, Timer: 15 sec), 'Slow Unload' (Timer: 30 sec), 'Slow Load' (Setpoint: 20.0 Psig, Timer: 30 sec), and 'Fast Load' (Pressure Offset: 4.0 Psig, Timer: 15 sec). A 'Start Offset' is set to 2.0 Psig. To the right, there are two 'Slide' controls for 'Capacity' and 'Volume', both at 0.0%, with buttons for 'Stop', 'Remote Lock Out', 'Alarm Reset', and 'Unit Start'. Below these are read-only status panels for 'Suction Press Control' (Setpoint: 20.0 Psig), 'Suction' (Press: 26.1 Psig, Temp: 55.0 °F), 'Discharge' (Press: 128.5 Psig, Temp: 71.5 °F), 'Discharge : Suction' (Press Ratio: 3.5), 'Oil' (Press Diff: 144.1 Psig, Filter Diff: 9.7 Psig, Inj Temp: 113.3 °F, Sep Temp: 109.9 °F), and 'Motor' (Amperage: 0.0 Amps). At the bottom, there are navigation buttons (Page 1-6, Menu), user access controls (Maintenance, User Access, Log off, Help), and a status panel showing 'No Scheduled Maintenance', 'No Alarm/Trips Present', 'User: admin', '11/07/2014 18:19:47', and 'Run Hours: 0'.

Figure B-8. Slave Compressor(s) Loading and Unloading Setup

## Appendix B • Vission 20/20 Application Procedures

to the “Compressor Control” menu of the Master Compressor.

### Fast Load Offset

- Defines the offset from the control setpoint to monitor compressor load. If suction pressure / process temperature surpasses this setpoint’s value then sequencing decisions are made according to the Fast Load Timer.

### Fast Unload Offset

- Defines the offset from the control setpoint to monitor compressor unload. If suction pressure / process temperature goes below this setpoint’s value then sequencing decisions are made according to Fast Unload Timer.

Users below security level 2 (Supervisor) are not allowed to edit the sequencing settings.

### Example:

Pressure control setpoints for setpoint 20 psig,

Start Offset = 2 psig

Fast Load Pressure Offset = 4 psig

Suction Pressure setpoint = 20 psig

Fast Unload Pressure Offset = 4 psig

Slow Load Timer = 30 sec

Fast Load Timer = 15 sec

Slow Unload Timer = 30 sec

Fast Unload Timer = 15 sec

### Assumptions:

- Master compressor is at 100% capacity

Suction pressure currently = 21 psig, so it falls within start offset defined above. The sequencing will not start and load highest priority slave when the suction pressure is below start offset setpoint.

Now assume suction pressure currently = 23 psig, it is above start offset, but less than fast load offset, so program will start slave compressor and monitor suction pressure every 30 sec (as per slow load timer).

Now assume suction pressure currently = 25 psig, it is above fast load offset, so program will monitor suction pressure every 15 sec (as per fast load timer).

Suction pressure currently = 17 psig, it is less than suction control setpoint, but greater than fast unload offset, so program will monitor suction pressure every 30 sec (as per slow unload timer).

Suction pressure currently = 15 psig, it is less than fast unload offset, so program will monitor suction pressure every 15 sec (as per fast unload timer).

## COMPRESSOR SEQUENCING EQUIPMENT LIST

The first page of the Compressor Sequencing menu allows the operator to view and adjust settings that are used for sequencing the slave compressors, see Figure B-7.

### Min Trigger:

- Defines the Master’s capacity value in percentage which is used as a trigger to the step-wise decrease of the slave compressor’s capacity. Slave compressor’s capacity is decreased only if the Master is running with capacity lower than set Min Trigger’s value.

### Max Trigger:

- Defines the Master’s capacity value in percentage which is used as a trigger to the step-wise increase of the slave’s compressor capacity. Slave compressor’s capacity is increased only if the Master is running with capacity higher than set Max Trigger’s value.

### Equipment

- The options of this combo box are updated depending on devices shown in the Devices List Page. This contains names of all the compressors in the network communicating with the Master compressor. Equipment names can be selected from drop-down list. The same Equipment name should not be configured more than once in the sequencing table.

### Examples of acceptable unique names:

- Master, slave no.1, slave no.2, comp no.1, comp no.2, etc.

### Control

- [ON/OFF] Inclusion/exclusion of a compressor partaking in the sequencing is decided on basis of this toggle button. Operator can include / exclude compressor by toggling the ON /OFF button.

### Example:

The operator can configure all settings for a particular slave compressor and set the control as OFF, so that it won’t be a part of sequencing steps. If the operator decides to enable this compressor by selecting ON, then it will be considered for the next load / unload cycle.



## Appendix B • Vission 20/20 Application Procedures

### NOTE

Switching a slave compressor control to OFF while it is running in Auto Sequencing mode puts the respective slave compressor into local auto mode. This feature is used to add / remove slave compressors to sequence table when running in Auto Sequence mode. The slave compressor can be put back into remote mode for sequencing by pressing Auto Start->Remote again on the slave compressor.

### PRIORITY

- This defines the priorities of compressors on the network. This priority will decide the sequence order in which compressors will be turned on and off during sequence cycle. The lower the priority number, the greater the priority of the compressor. The operator should choose the priorities of the compressors.

Example:

“1” is highest priority.

A compressor with priority “2” has higher priority than a compressor with priority “4”.

### STEP

- This parameter defines the size of the capacity step, for a slave compressor, that will occur when a change in capacity is needed. The step is defined as a percentage of the compressor capacity. In the case when the last step makes total capacity greater than the maximum capacity (Max Cap) setpoint, the total capacity will get reduced to the maximum capacity setting. The same is applicable when last step makes total capacity lower than minimum capacity (Min Cap) setpoint. The Min Cap setting will take priority.

Example:

Configured step = 20 %

Configured min cap = 10 %

Configured max cap = 80 %

Program starts loading slave compressor in steps of 20%, so the value of each interval will be:

Interval 1 – 10 % (min cap)

Interval 2 – 10% + 20% = 30 %

Interval 3 – 30% + 20% = 50 %

Interval 4 – 50% + 20% = 70 %

Interval 5 – 70% + 20% = 90 % (which is more than max cap, so last step will be 80%)

### MIN CAP / MAX CAP (slave compressors)

- Defines the lowest and highest capacity in percentage with which a slave compressor is allowed to run. Minimum capacity value takes preference on first step value. Maximum capacity value takes preference over last step value.

Example:

Configured step = 5 %

Configured min cap = 10 %

Configured max cap = 80 %

Program starts loading compressor in steps of 5%, so the value of each interval will be:

Interval 1 – 10 % (min cap)

Interval 2 – 10% + 5% = 15 %

Interval 3 – 15% + 5% = 20 %

Interval 4 – 20% + 5% = 25 %

.  
.

Last Interval – 75% + 5% = 80 % = ( max cap)

Max Trigger Example:

Configured Max Trigger = 85 %

Start Offset = 2 psig

Suction Pressure Setpoint = 20 psig

Suction Pressure Currently at 23 psig

Master’s Compressor Capacity at 90 %.

At this point, the Master compressor will start the machine start timer to start the next priority slave compressor available.

Min Trigger Example

- When the master compressor reaches its “Min Trigger” setpoint and the suction pressure is less than the suction control setpoint for the time period of the slow unload / fast unload timer, then the master will adjust (decrease) the slave compressor’s capacity. When a slave compressor has been unloaded to its MIN CAP setpoint, and the suction pressure is still less than the suction control setpoint for the time period of the slow unload / fast unload timer, a calculation of the operating CFM of the slave compressor is made. This value is compared against the available CFM of the other running compressors. If enough CFM is available, then the machine stop timer is started. When it times out, and provided there is still enough



## Appendix B • Vission 20/20 Application Procedures

CFM available from the remaining running compressors, the slave compressor is stopped.

### MACHINE START / STOP TIMER











- Machine start / stop timers show the time in seconds that the Master Compressor will hold before starting / stopping a slave compressor once the (Start / Stop) decision is taken. For further explanation of the operation of these timers, see Walk-through of Sequencing Loading and Unloading.

Status Symbols shown on the Master Compressor Sequencing menu, showing status of Slave compressors, see Table B-3.

### NOTE

Before configuring the Compressor Sequencing table on the master compressor, log on to slave compressors one by one and enable the sequencing in slave mode from the Configuration screen, then put each Vission 20/20 slave in Remote mode. Then log onto the master compressor and add slaves from the Device List Screen. After adding them, configure slaves from Equipment List table.

**Table B-3. Status Symbols**

	Default, If slave Compressor is not present.
	Slave Compressor is configured in sequencing table but is not configured in "Remote" mode or is not detected in network.
	Slave Compressor configured in sequencing table and is in ready to run state.
	Slave Compressor is running with Alarm condition.
	Slave Compressor stopped due to Error Condition.
	Slave Compressor running at maximum capacity without any error.
	Slave Compressor under active control of Master Compressor
	Slave Compressor running into its stop timer, will be stopped.
	Slave Compressor is next in sequence for unloading.
	Slave Compressor running into its start timer, will be started.

## Appendix B • Vission 20/20 Application Procedures

### CONFIGURING SEQUENCING TABLE ON MASTER COMPRESSOR

1. Select the correct compressor name from Equipment drop down list.
2. Assign the Priority for the slave compressor
3. Assign the Step size in percentage for the slave compressor
4. Assign Min/Max capacity values for the slave compressor
5. Repeat steps #1-4 to configure all slave compressors.

Auto Sequencing can be started (from the master compressor) by selecting the green Unit Start button and pressing the “Auto Seq” button.

### WALK-THROUGH OF SEQUENCING LOADING AND UNLOADING

#### (Assume Suction Pressure Control)

Example:

Pressure control setpoints for setpoint 20 psig,

Fast load offset = 4 psig

Start offset = 2 psig

Suction pressure control setpoint = 20 psig

Fast unload offset = 4 psig

Timers:

Slow load timer = 30 sec

Fast load timer = 15 sec

Slow unload timer = 30 sec

Fast unload timer = 15 sec

An example of partial loading of slaves, and shutting one off.

slave 3 – CFM (483) – running with Min Cap = 10%,

so the required CFM needed to handle slave 3 load =  $483 * 10 / 100 = 48.3$  CFM.

Now slave 2 is told to unload.

slave 2 – CFM (408) – running at max cap = 90%, step = 10%

so at Interval 1 – slave 2 receives a cap hold value = 80 %,

So, the available CFM =  $(408 * (90 - 80) / 100) = 40.8$  CFM

and the required CFM to absorb slave 3 load = 48.3 ( which is more than is available).

so at Interval 2 – slave 2 cap hold value = 70 %,

Now the available CFM =  $(408 * (90 - 70) / 100) = 81.6$  CFM

and since the required CFM to absorb slave 3 load is = 48.3, there is now enough available and slave 3 will be shutdown.

Machine start timer = 90 sec

Machine stop timer = 120 sec

Priorities:

Master -> slave 1 -> slave 2 -> slave 3.

Sequencing Loading mode operates in the following way:

The slave compressors are placed into Remote mode. The Master Compressor is started in “Auto Seq” mode. The Master Compressor program monitors its suction pressure value and identifies the load / unload rate band. During loading cycle when suction pressure reaches a value more than the configured start offset value ( $20 + 2 = 22$  psig) and if the master compressor reaches its Max Trigger value, then the master compressor starts machine start timer (90 sec). Once the machine start timer has elapsed, the master then picks the highest priority compressor (slave 1) from the list and starts loading the compressor to the Min Cap value for that slave. The program loads slave 1 as per steps configured till it reaches its Max Cap value. Once slave 1 starts running at Max Cap value and the suction pressure is still not within dead-band ( i.e. > start offset value of ( $20 + 2 = 22$ ) psig, then the program starts machine start timer (90 sec ) for the next priority compressor slave 2). This process is continued till either the setpoint is achieved or all compressors are running at their Max Cap values.

### OVERVIEW OF COMPRESSOR UNLOADING

The compressor unloading scheme incorporates an intelligent algorithm to identify when it is possible to turn a compressor off. When a slave compressor has been unloaded to its Min Cap value of capacity and the suction pressure is still less than a value of the suction control

setpoint for the time period of the unload timer, then a calculation of the operating CFM of the slave compressor is made. This value is compared against the available CFM of the other running compressors. If enough CFM is available, then the machine stop timer is started. When it times out, and provided there is still enough CFM available from the remaining running compressors, the slave compressor is stopped.

In the example below, during the unloading cycle when suction pressure falls below a value less than the suction control setpoint value (20 psig) for the time period of the unload timer, then the program picks the lowest priority compressor (slave 3) from the list and starts unloading the compressor. The program unloads slave 3 as per steps configured till it reaches its Min Cap setpoint. Once slave 3 is unloaded to its Min Cap setpoint and suction pressure is still below suction control setpoint, then the program picks the second lowest priority compressors (in this case slave 2 - eligible active compressor) from all running compressors list and starts unloading it. The program unloads slave 2 (eligible active compressor) to a point where it can handle the load of active compressor (running at min cap).

After the 2nd interval, it can be seen that slave 2 can handle the load of slave 3 so slave 3 can be stopped. The program then starts machine stop timer (120 sec) for the active compressor (slave 3) and stops the same when timer is lapsed. This process is continued till either setpoint is achieved or all compressors are stopped.

During the loading / unloading phase if the communication with any of the active / running / idle compressor is lost then master compressor logs event for the same. Compressor with errors / trip can be identified with its respective status symbol. The Master compressor acts as trim compressor

### SLAVE EXPERIENCING A FAILURE

When a slave compressor experiences an operational failure, then that slave will be temporarily skipped during the sequencing decisions. The slave will be placed into a “Local” mode. The fault needs to be reset and cleared before the compressor can be placed back into the sequencing routine. The slave compressor can be put back into remote mode for sequencing by pressing Auto Start->Remote again on the slave compressor. It will resume its “set” priority order and any future command to increase capacity of a slave compressor will result in the compressor being restarted.

#### 1. Master experiencing a Failure

When the master compressor experiences an operational failure, then it will continue to sequence the slave compressors based on the setpoints that are set in the sequencing menu of the master compressor.

#### 2. Power to master compressor turned off

If the power to the master compressor is turned off, then the slave compressors that are currently being sequenced will experience a “Remote Comm Timeout” – an indication that the slave has lost communication to the master compressor. This takes approximately 1 minute to occur and the “Remote Comm Timeout” message will be logged into the Event List on the slaves.

#### 3. Future Program Release

Advanced Sequence Configuration

Equalized Load Enable

- This selection on the master compressor will provide the ability to equalize (or balance) the load between compressors, allowing them to operate more efficiently. Rather than have one compressor operate at 70% and another operate at 30%, the balancing algorithm will determine a more efficient position for all compressors online.

#### Troubleshooting



1. If a slave compressor’s status shows this symbol, then the operator should check if the slave compressor is in Remote Idle mode.
2. Check the status symbols of all compressors on the sequencing table.
3. Check errors / info log on the compressor sequencing event log screen.

# Appendix B • Vision 20/20 Application Procedures

## Danfoss Liquid Injection Valve Setup

### NOTE

Consult the VSS / VSM / VSR Unit Manual for proper Danfoss ICM valve setup procedure.

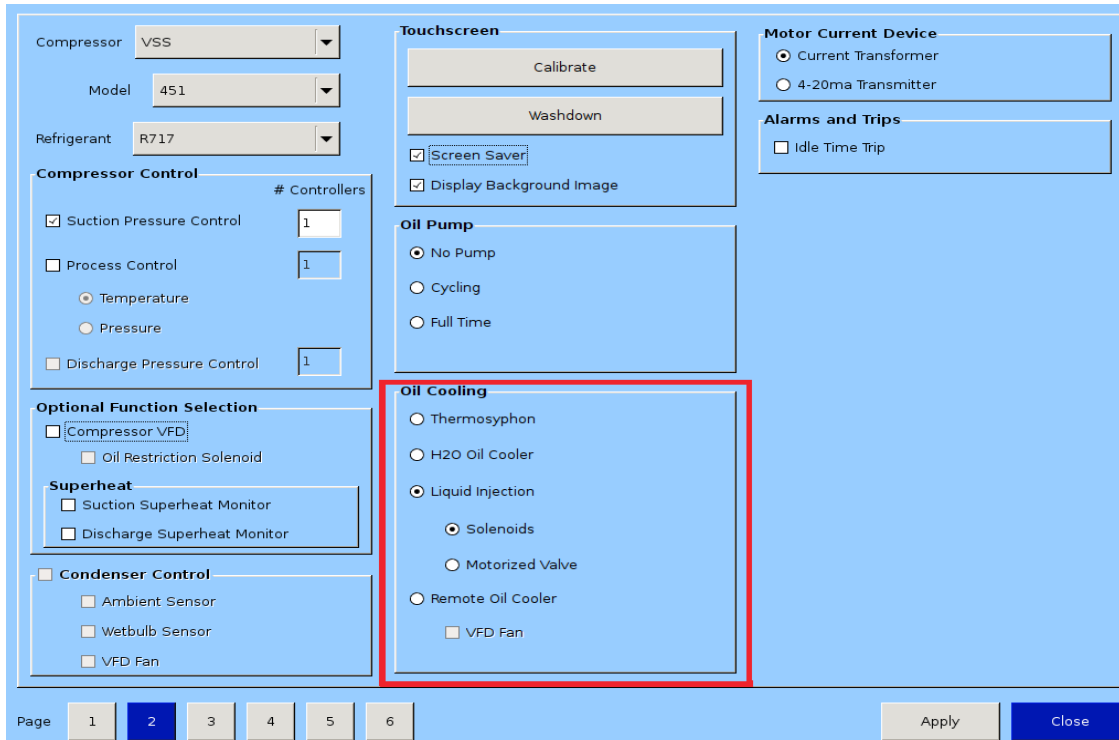

Figure B-10. Configuration Screen - Page 2 (Oil Cooling section)

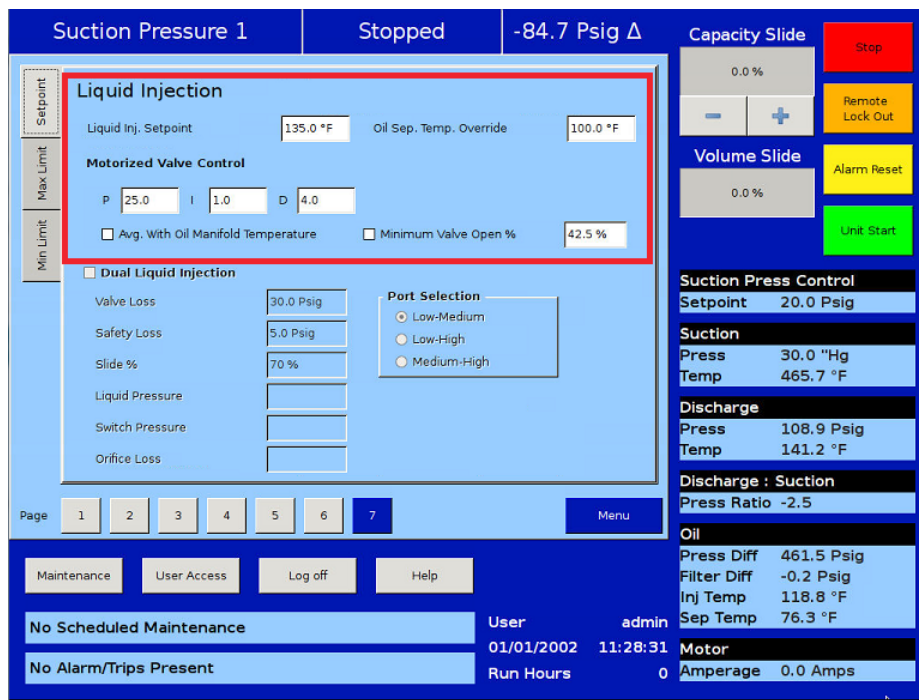

Figure B-11. Compressor Control Menu - Page 4 (Liquid Injection settings)

The Danfoss Liquid Injection valve is selected from the Configuration Screen - Page 2 (Under Oil Cooling Section.)  
The settings for the Danfoss Liquid Injection are setup in the Compressor Control Menu - Page 4.

# Appendix B • Vission 20/20 Application Procedures

## 485OPDRI-PH Heavy Industrial RS-422/485 Isolated Repeater

The iLinx™485OPDRI-PH is used to electrically isolate the RS485 signal from the network and to improve the signal strength of the RS485 signal over long distances. It provides powerful isolation on both data ports and protects equipment and data from damaging ground loops and surges. Additional isolation on the power supply circuits adds a third degree of protection

It has the added benefit of active noise suppression since it regenerates the active signal in relation to time and amplitude. Therefore, any noise on the signal lines into the device will not be passed through the device onto the network.

Figures B-12 A and B show the 2-wire and 4-wire network isolator.

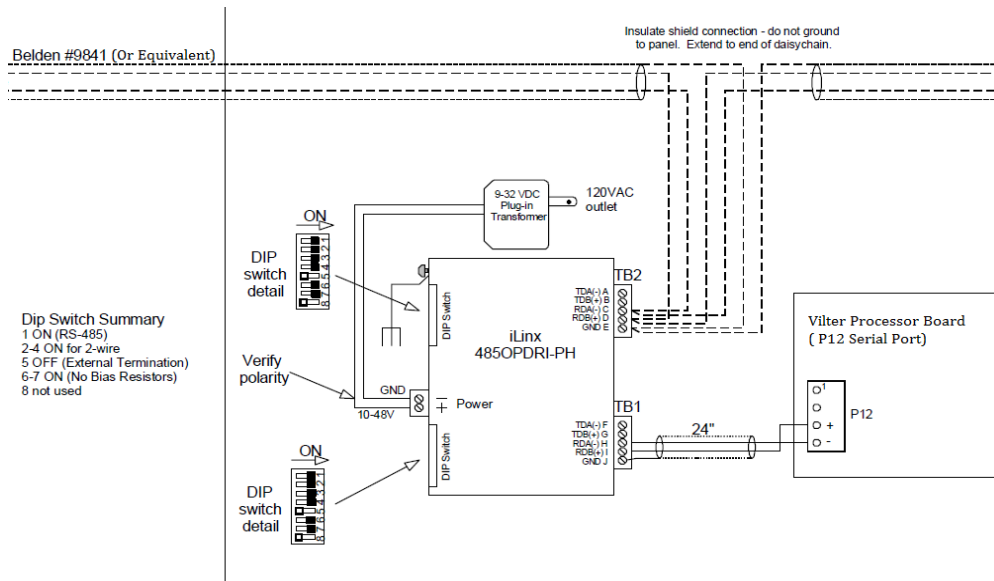

**Figure B-12 A**  
**iLinx 485OPDRI-PH**  
**2-wire Network Isolator**

Dip Switch Summary  
1 ON (RS-485)  
2-4 ON for 2-wire  
5 OFF (External Termination)  
6-7 ON (No Bias Resistors)  
8 not used

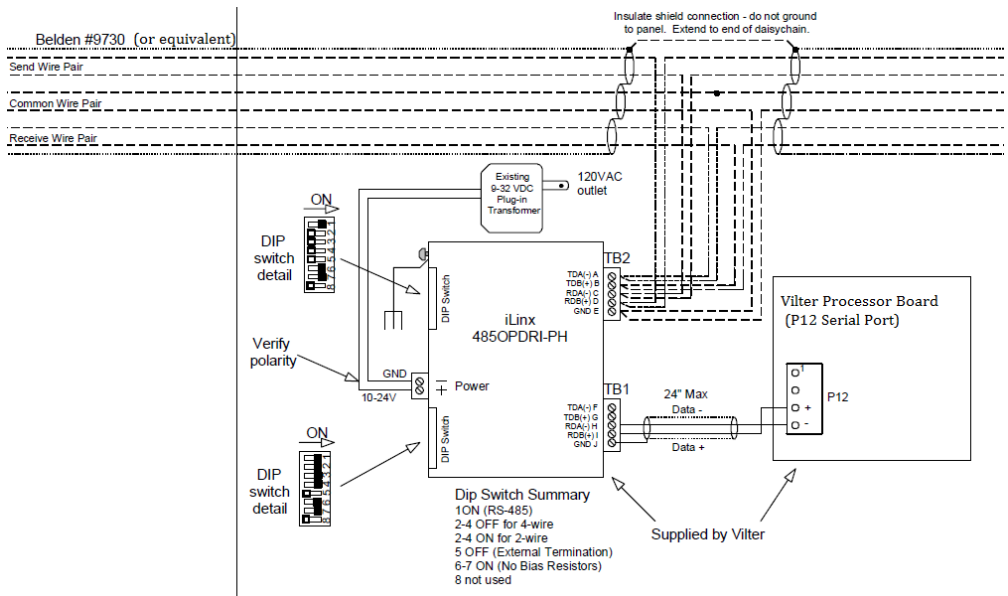

**Figure B-12 B**  
**ILINX 485OPDRI-PH**  
**4-wire Network Isolator**

Dip Switch Summary  
1ON (RS-485)  
2-4 OFF for 4-wire  
2-4 ON for 2-wire  
5 OFF (External Termination)  
6-7 ON (No Bias Resistors)  
8 not used

## Appendix B • Vission 20/20 Application Procedures

### Test 1

The first test measured the noise on the active network WITHOUT the ILinx™485OPDRI-PH isolator installed in the network. The USB/RS485 convertor was wired directly to the Vission 20/20 RS485 serial port.

The following screen capture from the scope shows the amount of noise on the network signals, see Figure B-13.

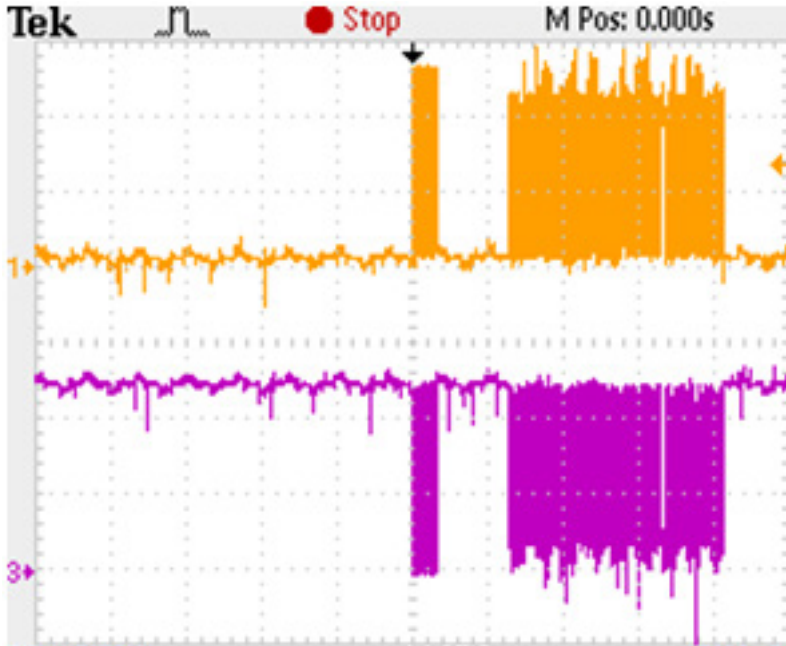

Figure B-13. Network Noise

### NOTE

The ILinx™485OPDRI-PH was powered from the +24vDC supply from the Vission 20/20 panel in this test, to measure the benefits of the isolator on an RS485 serial network running Modbus RTU protocol.

### Test 2

The second test measured the noise on the active network with the ILinx™485OPDRI-PH isolator installed in the network. The following screen capture (Figure B-14) from the scope shows the amount of noise on the

network signals.

The noise on the signal lines has been significantly reduced with the addition of the ILinx™485OPDRI-PH isolator installed in the network.

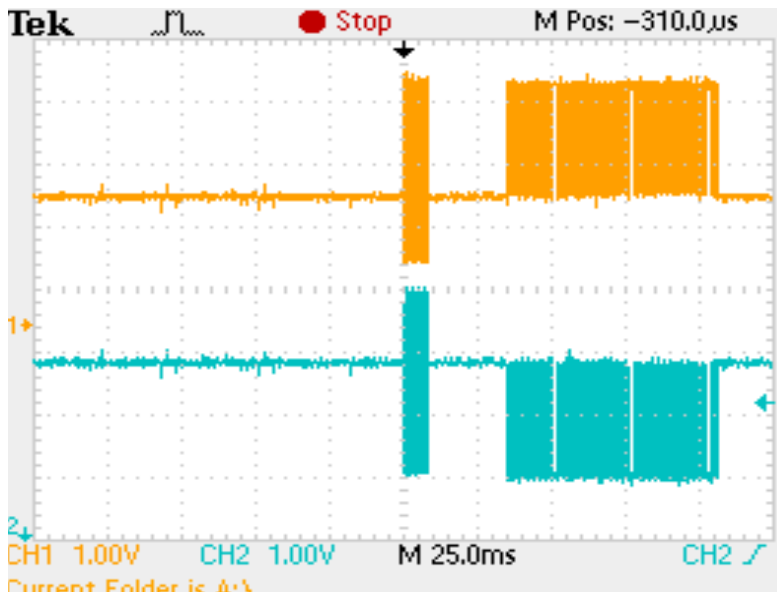

Figure B-14. Network Noise with Phoenix Contact PSM-ME Isolator

To order this isolator, please use Vilter part number 3485C1.



# Appendix B • Vission 20/20 Application Procedures

## Vessel Level Control Setup for 20/20 Panel

### INTRODUCTION

This document provides guidelines to successfully set-up a vessel level control function in the Vilter™ Vission 20/20™ control panel. Vessel level control is achieved using a level probe wired to an auxiliary analog input channel of the 20/20, thereby providing a 4-20mA signal proportional to the vessel liquid level. Then based on the liquid level setpoint entered into the 20/20, the analog output card of the 20/20 will send a varying 4-20mA signal to a positioning valve, to open or close it to achieve a desired level of liquid in the vessel.

### ADDITIONAL VISSION 20/20 HARDWARE

An additional analog input card is required to sense the 4-20mA signal from the level probe.

An analog output card is required to output a 4-20mA

signal to the positioning valve, thereby increasing and decreasing the amount of liquid being fed to the vessel.

If a level switch is installed in or on the vessel for an alarm or trip function, then an additional digital input card will be required as well.

### SETUP

#### Step 1: Configuration Screen Selection of Installed Boards

Log on and navigate to the Configuration screen, page number 6, see Figure B-15. Insure that all boards that are physically installed into the Vission 20/20 panel have been selected or “checked”. You should have additional boards 8 and 10, and possibly board 4. Board numbering starts from the left column, top to bottom are boards 1 to 5. On the right column, top to bottom are boards 6 to 10.

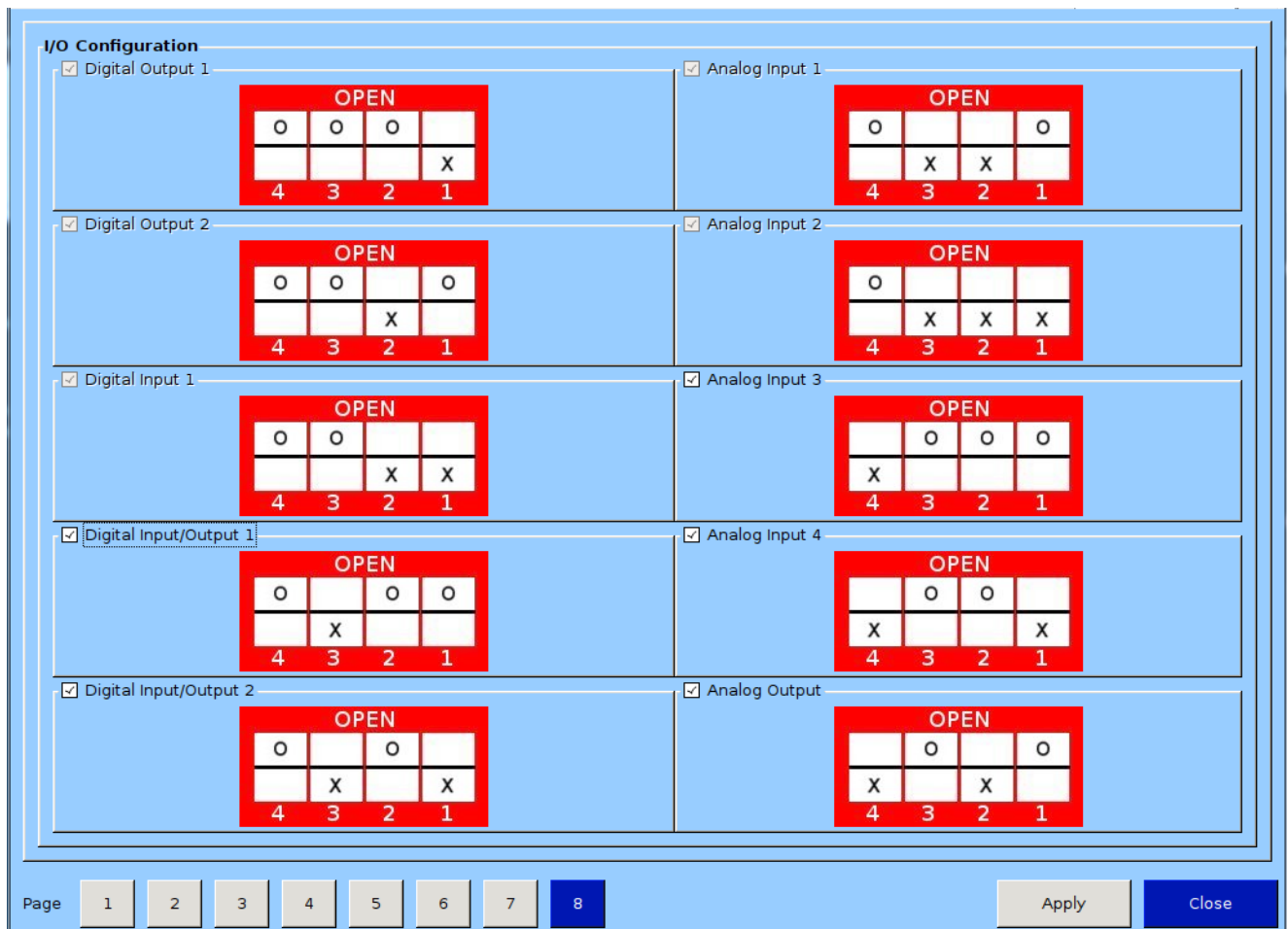

Figure B-15. Selection of Installed Boards from Configuration Screen (Configuration Screen – Page 6)

## Appendix B • Vision 20/20 Application Procedures

### Step 2: Selection and Naming of Auxiliary Analog Outputs used for Level Control

Navigate to page 7 of the Configuration screen and select the analog output(s) that will be used modulating the positioning valve(s) on the vessel(s). Also provide a name for the analog output(s). You'll need to reference your wiring diagram to determine which analog output(s) need to be enabled.

In the example in Figure B-16, Auxiliary #1 Analog Output was renamed to “Chiller Level 4,20 Out” and Auxiliary #2 Analog Output was renamed to “Condenser Level 4,20 Out”. Referencing the wiring diagram, please note that Aux #1 Analog Output corresponds to AO#5 on the wiring diagram, and Aux #2 Analog Output corresponds to AO#6 of the wiring diagram.

The screenshot displays the 'Auxiliary Outputs' configuration screen, divided into 'Analog Outputs' and 'Digital Outputs' sections. The 'Analog Outputs' section is active, showing four output configurations. The first two are enabled, with names 'Chiller Level 4,20 Out' and 'Condenser Level 4,20 Out'. The last two are disabled, with names 'Analog Aux out 3' and 'Analog Aux out 4'. The 'Digital Outputs' section is inactive, showing four disabled outputs with names 'Digital Aux out 1' through '4'. At the bottom, a page navigation bar shows page 7 selected, along with 'Apply' and 'Close' buttons.

Section	Output #	Enabled	Set Name
Analog Outputs	1	Yes	Chiller Level 4,20 Out
	2	Yes	Condenser Level 4,20 Out
	3	No	Analog Aux out 3
	4	No	Analog Aux out 4
Digital Outputs	1	No	Digital Aux out 1
	2	No	Digital Aux out 2
	3	No	Digital Aux out 3
	4	No	Digital Aux out 4

Figure B-16. Enabling and Naming Analog Outputs (Configuration Screen – Page 7)



## Appendix B • Vission 20/20 Application Procedures

### Step 3: Selection and Naming of Auxiliary Analog Inputs used for Level Control

Navigate to page 6 of the Configuration screen and select the analog inputs(s) that will be used for sensing the 4-20mA signal from the vessel(s) level probe(s). Also provide a name for the analog input(s). You'll need to reference your wiring diagram to determine which analog inputs need to be enabled.

In the example in Figure B-17, Auxiliary #5 Analog Input was renamed to “Chiller Level 4,20 Input” and Auxiliary

#6 Analog Input was renamed to “Condenser Level 4,20 Input”. Referencing the wiring diagram, please note that Aux #5 Analog Input corresponds to Channel #21 on the wiring diagram and Aux #6 Analog Input corresponds to Channel #22 on the wiring diagram.

After steps 1, 2 and 3 have been completed, then press the APPLY button and then press the CLOSE button to exit the Configuration screen.

Continue to step 4.

Input #	Enable	Set Name
1	<input type="checkbox"/>	Analog Aux in 1
2	<input type="checkbox"/>	Analog Aux in 2
3	<input type="checkbox"/>	Analog Aux in 3
4	<input type="checkbox"/>	Analog Aux in 4
5	<input checked="" type="checkbox"/>	Chiller Level 4,20 Input
6	<input checked="" type="checkbox"/>	Condenser Level 4,20 Input
7	<input type="checkbox"/>	Analog Aux in 7
8	<input type="checkbox"/>	Analog Aux in 8
9	<input type="checkbox"/>	Analog Aux in 9
10	<input type="checkbox"/>	Analog Aux in 10
11	<input type="checkbox"/>	Analog Aux in 11
12	<input type="checkbox"/>	Analog Aux in 12
13	<input type="checkbox"/>	Analog Aux in 13
14	<input type="checkbox"/>	Analog Aux in 14
15	<input type="checkbox"/>	Analog Aux in 15
16	<input type="checkbox"/>	Analog Aux in 16

Figure B-17. Enabling and Naming Analog Inputs (Configuration Screen – Page 6)

## Appendix B • Vission 20/20 Application Procedures

### Step 4: Instrument Calibration Screen Setup of Auxiliary Analog Inputs.

Now that the auxiliary analog inputs have been selected and named, the scaling for the inputs needs to be setup. Navigate to Instrument Calibration screen page 4 and setup the auxiliary analog input(s). These inputs are 4-20mA signals and the scaling will be setup so that:

- The units of this signal are in “percent”.
- 4 mA signal corresponds to 0% level.
- 20 mA signal corresponds to a 100% level.

The setup example shown in Figure B-18, Auxiliary #5 Analog Input was setup so that the units of the input will readout in “percent”. At 4.0mA input, the level percentage is equal to 0.0%. At 20.0mA input, the level percentage is equal to 100.0%. Setup Auxiliary #6 analog input in the same way.

Continue to step 5.

The screenshot displays the Instrument Calibration screen for Auxiliary Analog Inputs. The top status bar shows 'Suction Pressure 2', 'Stopped', and '-6.9 Psig Δ'. The main area is titled 'Analog Inputs' and lists eight auxiliary inputs. Input #5, 'Chiller Level 4...', is selected. The calibration settings for this input are:

- I/O:** A/D bit Value: 5, Calibrated Value: 0.0 %
- Device Calibration:** Units: Percent (%), Min: 0.0 %, Max: 0.0 %
- Channel Calibration:** Offset: Adjustment: [empty], Total Offset: 0.0, Range: I/O jumpers selection: 4ma - 20ma, Min: 4.0 ma, Max: 20.0 ma

On the right side, there are control panels for 'Capacity Slide' (3.5%), 'Volume Slide' (0.7%), and 'Suction Press Control' (Setpoint: 30.0 Psig). Below these are readouts for 'Suction' (Press: 23.1 Psig, Temp: 43.1 °F) and 'Discharge' (Press: 147.3 Psig, Temp: 175.7 °F). At the bottom, there are status indicators for 'No Scheduled Maintenance' and 'No Alarm/Trips Present', along with user information (User: admin, Date: 07/04/2017, Time: 02:01:07, Run Hours: 15) and 'Motor Amperage' (1.4 Amps).

Figure B-18. Scaling Setup for Auxiliary Analog Inputs

## Appendix B • Vission 20/20 Application Procedures

### Step 5: Auxiliary I/O (Analog Inputs) Alarm and Trip Setup

If an alarm or trip setpoint for the vessel level is desired, then navigate to Auxiliary I/O page 3 and setup any alarm or trip function for the vessel level.

You have the option to select:

- Alarm / Trip : Neither, Alarm Only, Trip Only, Both
- Inhibit: Checking the Inhibit box will prevent the compressor from starting if the analog input falls below the Low Alarm setpoint or above the Hi Alarm

setpoint. If the compressor is running while this occurs, it will not shutdown if the “Alarm Only” function were selected (as shown below).

- In the example in Figure B-19, Auxiliary #5 and #6 Analog Inputs were setup to function as “Alarm Only”. The alarm points have been set to 0% and 75% level. These values would need to be adjusted for appropriate alarm values. The inhibit box was not selected in the example above, so the compressor will start even when the analog inputs are outside the alarm ranges shown.
- Continue to step 6.

The screenshot displays the 'Suction Pressure 2' control panel. At the top, it shows 'Stopped' and '-6.9 Psig Δ'. The main area is divided into 'Analog Inputs' and 'Analog Aux' sections. 'Analog Aux in 1-4' are set to 'Neither' with '0.0 °F' setpoints. 'Aux5: Chiller Level 4,20 Input' and 'Aux6: Condenser Level 4,20 Input' are set to 'Alarm Only' with '0.0 %' setpoints. A right-hand sidebar contains 'Capacity Slide' (3.5%), 'Volume Slide' (0.7%), and buttons for 'Stop', 'Remote Lock Out', 'Alarm Reset', and 'Unit Start'. Below the slides are 'Suction Press Control' (Setpoint 30.0 Psig), 'Suction' (Press 23.1 Psig, Temp 43.1 °F), 'Discharge' (Press 147.4 Psig, Temp 175.7 °F), 'Discharge : Suction' (Press Ratio 4.3), and 'Oil' (Press Diff 141.7 Psig, Filter Diff 9.9 Psig, Inj Temp 104.6 °F, Sep Temp 110.3 °F). The bottom status bar shows 'No Scheduled Maintenance', 'No Alarm/Trips Present', 'User: admin', 'Date: 07/04/2017', 'Time: 02:00:28', and 'Run Hours: 15'.

Figure B-19. Auxiliary I/O Alarm and Trip Setup

# Appendix B • Vission 20/20 Application Procedures

## Step 6: Setup of Analog Output for Vessel Level Control – PID Level Control

Navigate to Auxiliary I/O page 6 and setup analog output control for vessel level.

The screenshot displays the Vission 20/20 control interface. At the top, it shows 'Suction Pressure 1', 'Stopped', and '5.2 Psig Δ'. The main area is divided into two columns for 'Aux1: Chiller Level 4,20 Out' and 'Aux2: Condenser Level 4,20 Out'. Both are configured with 'Auxiliary Input', 'Analog Input', and 'PID Control' selected. The PID settings for both include a P (Gain) of 25.0, I (Reset) of 0.0, and D (Rate) of 0.0. The setpoint is 50.0. The 'Trigger' section for both is set to 'None' with a 'Trigger Value' of 50.0 and a 'Differential' of 2.0. The 'Control Method' section shows 'PID Control' selected over 'Scalable Control'. The 'Scalable Control' section shows 'Min Input' at 0.0, 'Min Output' at 12.0, 'Max Input' at 50.0, and 'Max Output' at 20.0. The 'Inverse' and 'Negative Error' checkboxes are unchecked. On the right side, there are 'Capacity Slide' and 'Volume Slide' controls, both at 0.0%. Below these are buttons for 'Stop', 'Remote Lock Out', 'Alarm Reset', and 'Unit Start'. The bottom right corner shows a summary of system parameters: Suction Press Control (Setpoint 8.0 Psig), Suction (Press 13.2 Psig, Temp 43.1 °F), Discharge (Press 138.7 Psig, Temp 110.1 °F), Discharge : Suction (Press Ratio 5.5), Oil (Press Diff 142.6 Psig, Filter Diff -13.1 Psig, Inj Temp 105.1 °F, Sep Temp 129.5 °F), and Motor (Amperage 1.3 Amps). The bottom left shows 'Page 1-7' and 'Menu' buttons, and the bottom center shows 'Maintenance', 'User Access', 'Log off', and 'Help' buttons. The bottom right shows 'User admin', '07/11/2017 01:50:50', 'Run Hours 4', and 'No Scheduled Maintenance' and 'No Alarm/Trips Present' status.

Figure B-20. PID Level Control (Auxiliary I/O – Page 6)

### CHILLER LEVEL CONTROL

Suppose we are trying to maintain a level of liquid in a chiller. As the level decreases, we want to stroke a positioning valve “more open” to allow more liquid to feed into the chiller.

In the example in Figure B-20, examine the setup of Aux1: Chiller Level 4,20 Output - on the left side of the screen. The “Run Always” selection box is not checked, so the control of the positioning valve will only occur while the compressor is running.

For the setup in Figure B-20, the Auxiliary #1 analog output signal (which is the 4-20 ma signal to the chiller Level positioning valve ) is controlled by the Auxiliary Input “Chiller Level 4,20 input” - which was configured in Steps

3, 4 and 5 above. PID Control has been selected, with a 50% setpoint.

The “Trigger Input” is enabled and the trigger setpoint is set at 50% (same as the setpoint). When the trigger input conditions go to a “true” state ( in this case, the trigger goes to a true state when the chiller level drops BELOW the setpoint), only then will the auxiliary analog output control be enabled. In the above example, when the chiller level is above 50%, the positioning valve will be fully closed. As it drops below 50%, then the positioning valve will begin to open.

The PID setpoints are selected so that only the P term (gain) is being used. With these settings, the positioning valve will be adjusted in response to the “error” from the desired setpoint.

## Appendix B • Vission 20/20 Application Procedures

With the above setting, the response of the Aux1: Chiller Level 4,20 Output is seen to be;

% Level Input		Aux1 Analog Output
50 %	=	4 ma (fully closed position)
45 %	=	8 ma
40 %	=	12 ma
35 %	-	16 ma
30 %	=	20 ma (fully open position)

So a 20 % change in vessel level will cause the positioning valve to go from a closed position to fully open position.

Decreasing the gain (P term) to 12.5 (by half) – will decrease the output sensitivity to a input change. The positioning valve will be stroked from closed to full open position over a larger swing in vessel level. When you decrease the gain by half, then the 4-20ma output signal to the positioning valve is applied over an input range that is doubled;

% Level Input		Aux1 Analog Output
50 %	=	4 ma
40 %	=	8 ma
30 %	=	12 ma
20 %	=	16 ma
10 %	=	20 ma

Now a 40 % change in vessel level will cause the positioning valve to go from a closed position to fully open position.

### CONDENSER LEVEL CONTROL

Suppose we are trying to maintain a level of liquid in a condenser. The condenser has a sump, and as the level in the sump increases, we want to stroke a positioning valve “more open” ( to allow more liquid refrigerant to drain) thereby decreasing the amount of liquid in the condenser sump.

Reference the previous page. On the right side is the setup for the condenser PID control. The setup is almost the same with the exception that the trigger condition is selected so that it goes true when the chiller level rises above the setpoint, only then will the auxiliary analog output control be enabled. In the above example, when the chiller level is below 50%, the positioning valve will be fully closed. As it rises above 50%, then the positioning valve will begin to open.

### ANALOG OUTPUT SETUP FOR VESSEL LEVEL CONTROL – PROPORTIONAL LEVEL CONTROL

Setting up the vessel level control using proportional control allows you to define the exact percent opening of the positioning valve based on the vessel level input signal. This mode of operation for level control is not as common since the valve opening is in direct proportion to the defined input range, and doesn’t consider a “setpoint” or “error from setpoint”. It simply moves the positioning valve in direct relation to the defined level input signal. This requires a lot of testing to know what the correct input and output range is needed to achieve a desired level.

You can define an input range to cover the entire 0-100% input span, or you can define a partial range – for instance 0 to 50%, see Figure B-21. The output can be the full 4-20ma output range, or a partial range (for instance 12 to 20 ma). The input and output ranges are completely flexible. In addition, you can define an Inverse output. The proportional control on the left is setup such that for a 0 to 100% input, the respective output ranges 20 ma to 4 ma (inverse acting output).

# Appendix B • Vision 20/20 Application Procedures

Suction Pressure 1
Stopped
5.2 Psig  $\Delta$

### Analog Outputs

**Aux1: Chiller Level 4,20 Out**

Standard Input    Auxiliary Input

Run Always   Active Input Chiller Level 4,20 Ir

Trigger

Trigger Input    Analog Input    Digital Input

None   Enable If Above / ON

Trigger Value   0.0   Differential   2.0

**Aux2: Condenser Level 4,20 Out**

Standard Input    Auxiliary Input

Run Always   Active Input Condenser Level 4,

Trigger

Trigger Input    Analog Input    Digital Input

None   Enable If Above / ON

Trigger Value   0.0   Differential   2.0

**Control Method**

PID Control    Scalable Control

P (Gain)	0.0	Min Input	Min Output
I (Reset)	0.0	0.0	20.0
D (Rate)	0.0	Max Input	Max Output
Setpoint	0.0	100.0	4.0

Inverse  
 Negative Error

**Capacity Slide**

0.0 %

-   +

**Volume Slide**

0.0 %

-   +

Stop

Remote Lock Out

Alarm Reset

Unit Start

**Suction Press Control**

Setpoint   8.0 Psig

---

**Suction**

Press   13.2 Psig

Temp   43.1 °F

---

**Discharge**

Press   138.7 Psig

Temp   110.1 °F

---

**Discharge : Suction**

Press Ratio 5.5

---

**Oil**

Press Diff   142.6 Psig

Filter Diff   -13.1 Psig

Inj Temp   105.1 °F

Sep Temp   129.5 °F

---

**Motor**

Amperage   1.3 Amps

Page   1   2   3   4   5   **6**   7   Menu

Maintenance   User Access   Log off   Help

---

**No Scheduled Maintenance**   User   admin

**No Alarm/Trips Present**   07/11/2017   01:50:50

Run Hours   4

Figure B-21. Proportional Level Control (Auxiliary I/O – Page 6)

## Appendix B • Vission 20/20 Application Procedures

### VPLUS (AC Motor) Setup Procedure for 20/20 Panel

#### INTRODUCTION

This document provides guidelines to setup AC Motor VPLUS oil cooling system control on the Vission 20/20 panel. Further information can be found in the VPLUS IOM manual (#35391XA).

#### SCOPE

Vilter™ AC VPLUS oil cooling system utilizes a PID algorithm in the Vission 20/20 panel to control the speed of the VPLUS motor. The motor speed controls the amount of liquid refrigerant being injected into the compressor which is used for oil cooling. Motor speed is based on discharge temperature. As the discharge temperature varies from the liquid injection control setpoint, a modulating 4-20ma signal wired to the AC motor VFD will adjust the speed of the motor.

This document provides instructions to help setup the Vission 20/20 for VPLUS (AC Motor) control.

#### ADDITIONAL HARDWARE

In order to control the VPLUS pump motor VFD, an analog output card is required. The 4-20ma signal from the card will be wired to the VFD and will vary the speed of the VPLUS motor - thereby increasing and decreasing the amount of liquid refrigerant that will be injected into

the compressor to provide oil cooling.

#### HARDWARE WIRING

The analog output card needs to be wired to the VPLUS VFD, see Figure B-22 and Figure B-23.

The VPLUS VFD needs to be wired to the VPLUS Motor, see Figure B-23.

The digital output card needs to be wired to the VPLUS liquid injection solenoid, see Figure B-24.

A control relay must also be installed for the VPLUS VFD Start, see Figure B-23 and Figure B-24. The control relay is not supplied by Vilter™.

#### VPLUS VFD Settings

In order to achieve a stable liquid injection control, the VPLUS VFD “Maximum Frequency” setting should be set to 38 Hz. This setting is arrived at by matching the historical setting for the DC VPLUS system which used a DC voltage motor controller board to control the speed of a DC motor. On the DC VPLUS system, the DC VPLUS motor had a 90vDC armature. The motor controller board was then set so that the maximum DC voltage to the DC motor was 57 volts DC. This number was arrived at through empirical testing, which provided stable liquid injection control. Translating this to the AC VPLUS system then, the maximum frequency setting on the VFD should be  $(57/90 \times 60 \text{ Hz} = 38 \text{ Hz})$ .

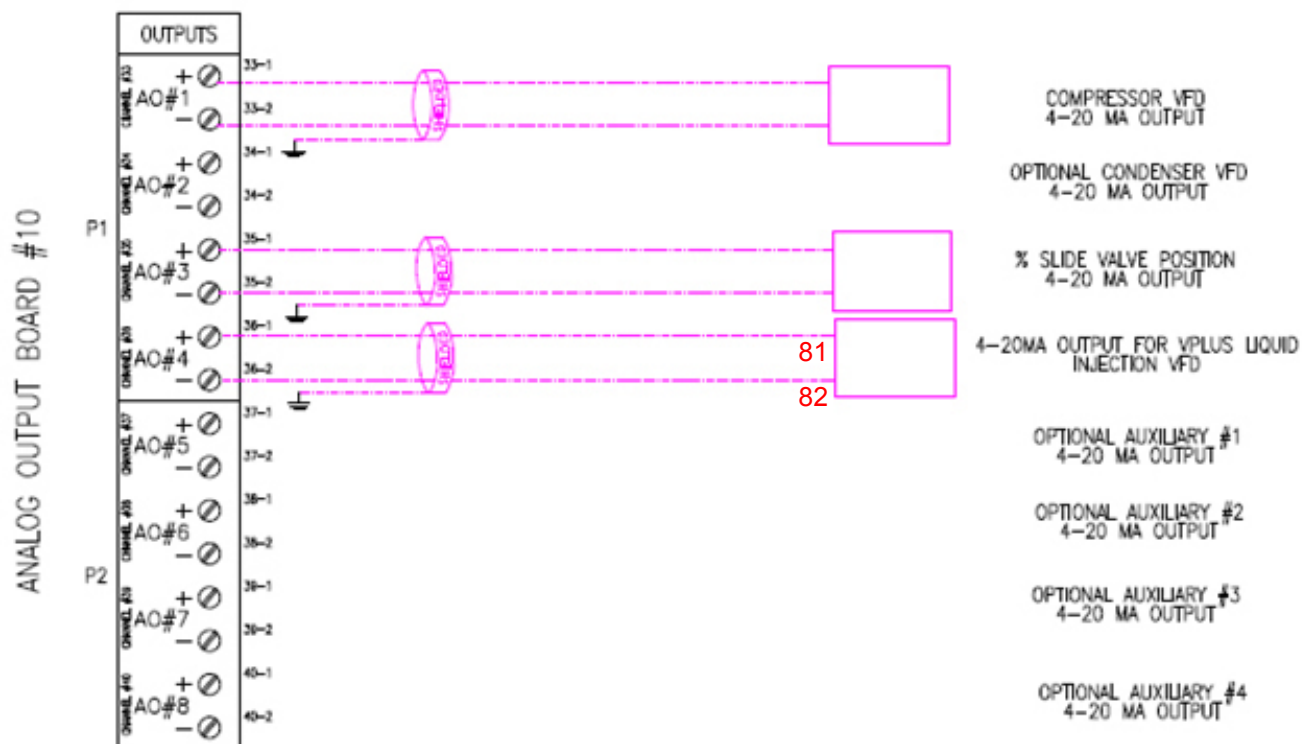

Figure B-22. Analog Output card wiring to VPLUS VFD controller



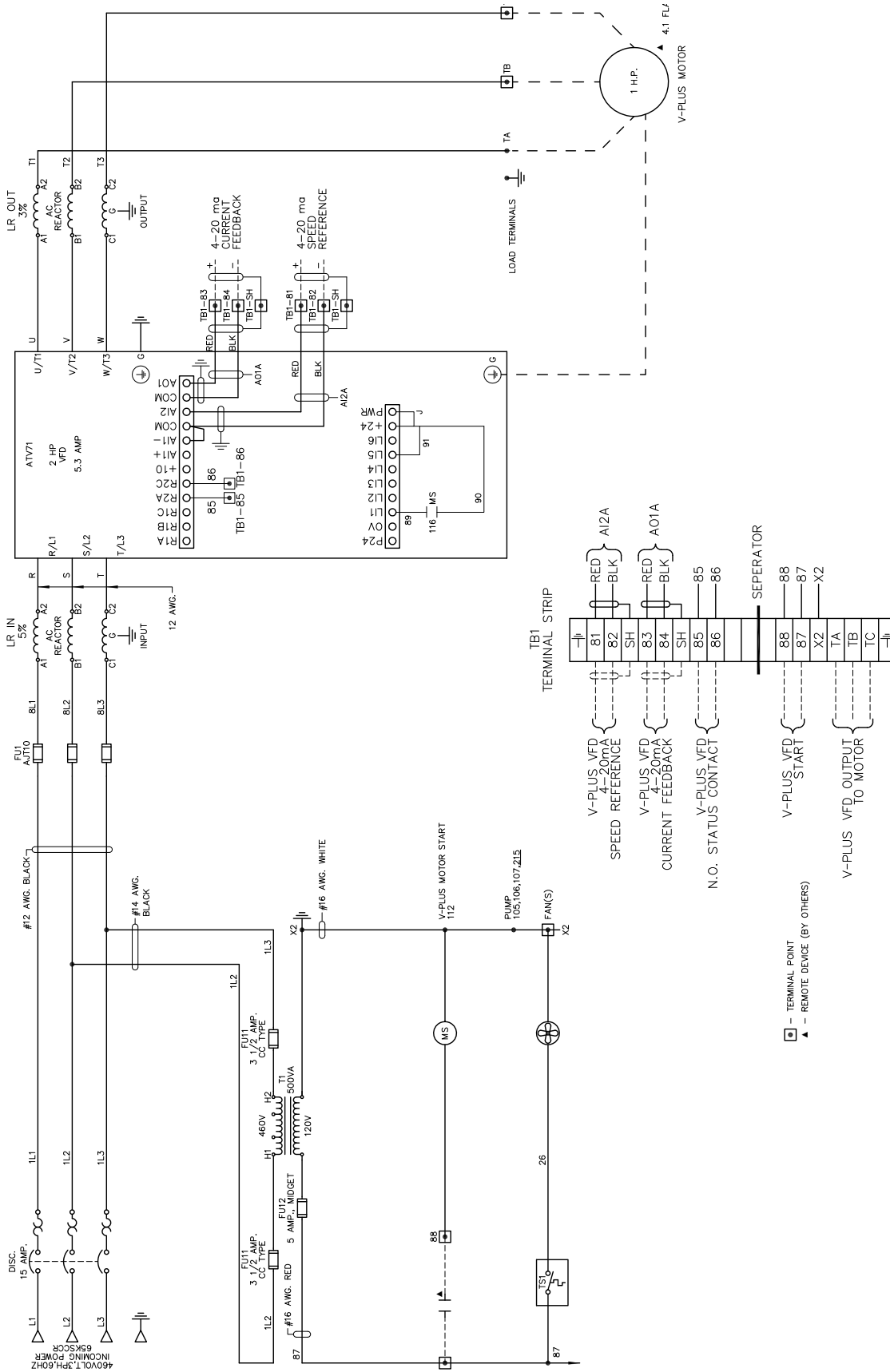

Figure B-23. VPLUS VFD (Altivar 71) Schematic



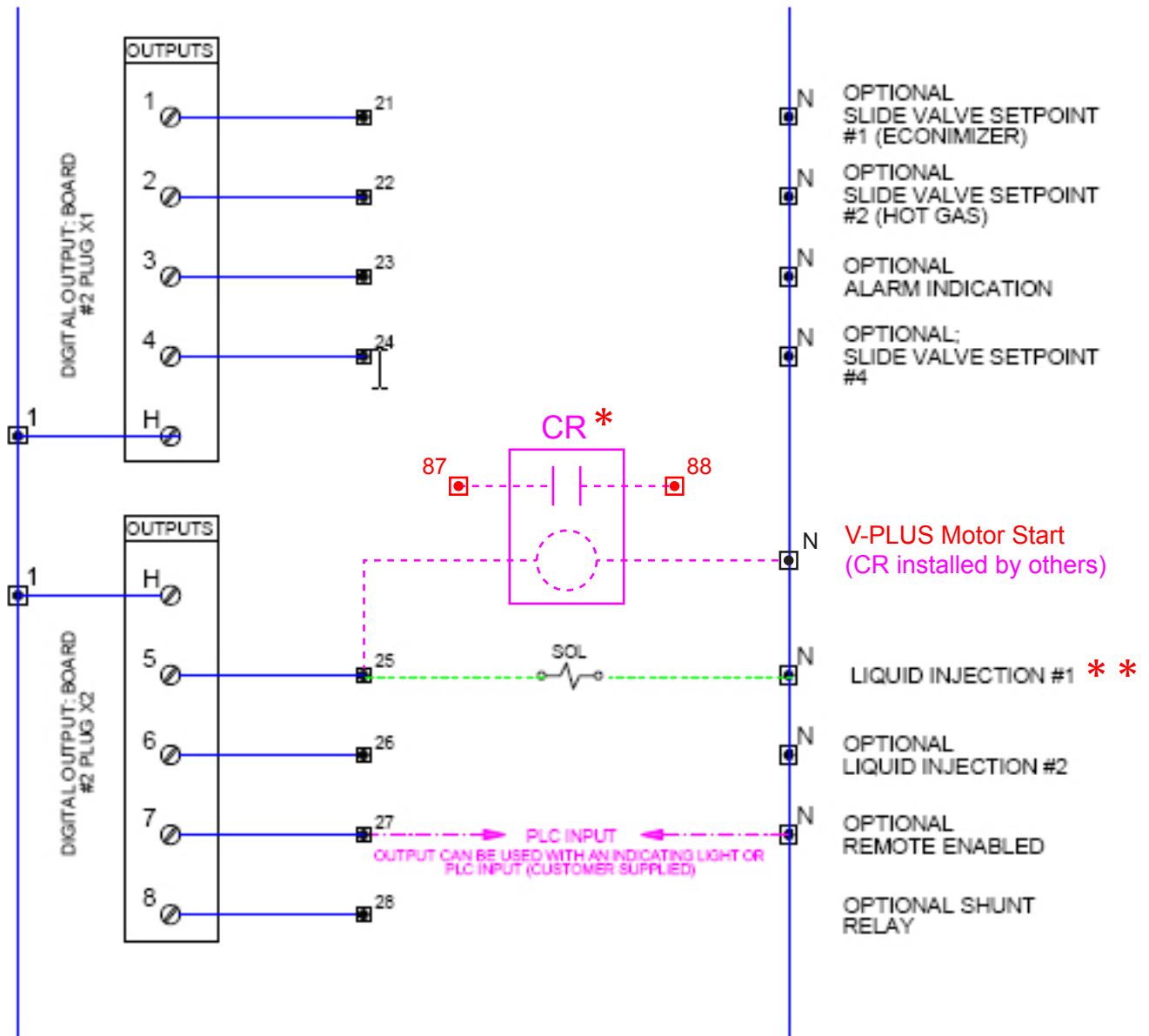

Figure B-24. Digital Output Card Wiring to VPLUS Liquid Injection Solenoid and VPLUS VFD Start

- \* The Control Relay (CR) can be installed in the V-PLUS panel or Vission 20/20 panel. Connections 87 and 88 are in the V-PLUS panel, see Figure B-23.
- \*\* Liquid Injection #1 Solenoid is energized and de-energized via the “Liquid Injection Setpoint #1” setpoint in the Control Limits Menu (Liquid Injection Section). The Oil Separator Temp Override Setpoint is also active and will not allow the Liquid Injection solenoid to energize until the Oil Separator Temp is above the Oil Separator Temp Override Setpoint.

# Appendix B • Vission 20/20 Application Procedures

## VISSION 20/20 SOFTWARE SETUP

### Step 1: Configuration Screen Selection of Installed Boards

Log on and navigate to the Configuration screen, page number 6. Insure that all boards that are physically

installed into the Vission 20/20 panel have been selected or “checked”. You should have the additional board #10 installed (analog output board) and selected.

Continue to Step 2.

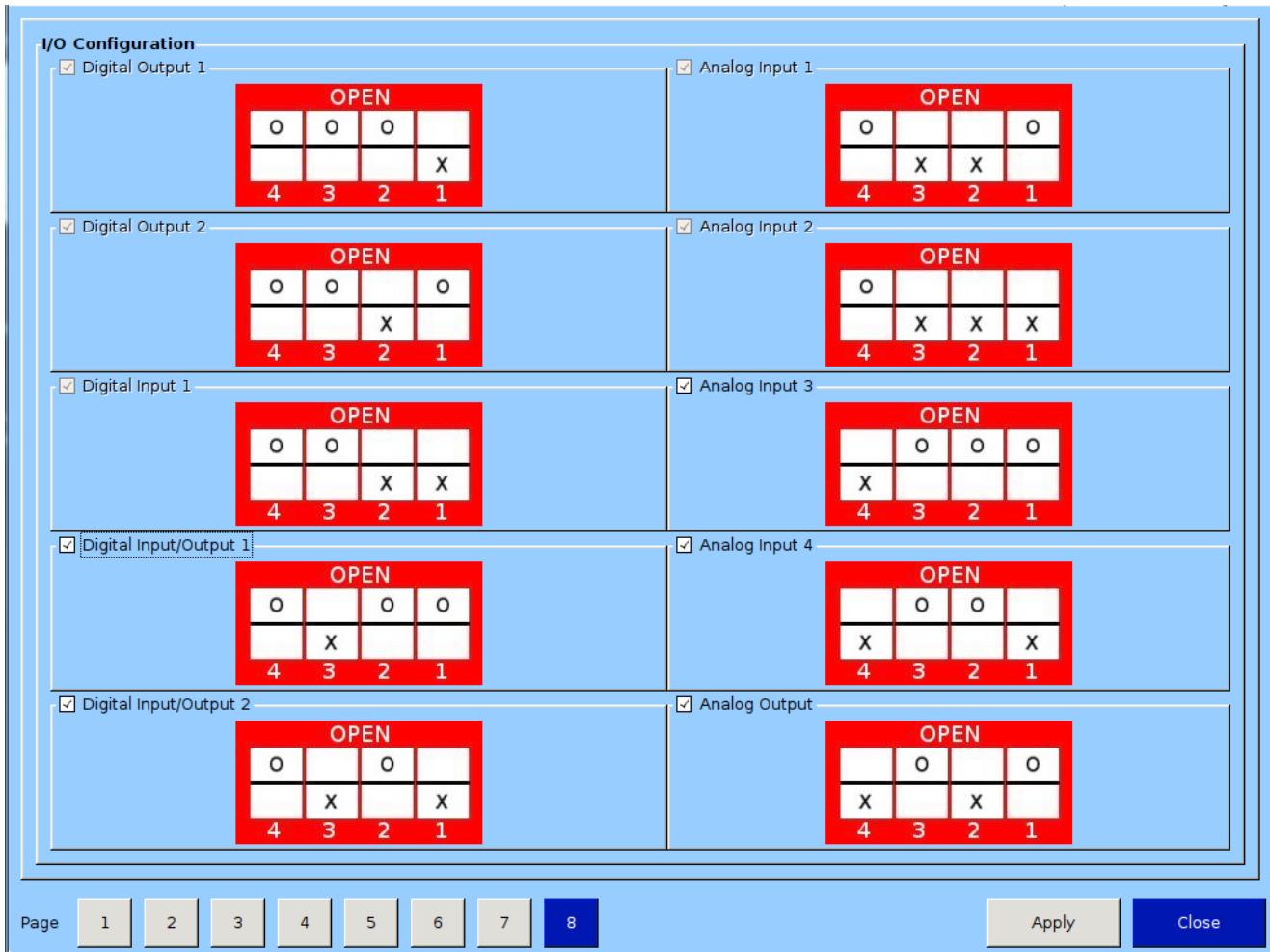

Figure B-25. Selection of Installed Analog Output Board (Configuration Screen – Page 6)

## Appendix B • Vission 20/20 Application Procedures

### Step 2: Setup and selection of Oil Cooling from page 2 of the Configuration screen

The oil cooling VPLUS algorithm must be enabled from the configuration screen. The algorithm used for this is the same one that is used to control the oil cooling motorized positioning valve. Navigate to page 2 of the Configuration screen. In the middle column, towards

the bottom of page 2 are the Oil Cooling selections, see Figure B-26. Select “Liquid Injection” method and then select the “Motorized Valve” selection. Note that by selecting the positioning valve algorithm, the speed of the VPLUS motor is being controlled based on the discharge temperature only.

Continue to step 3.

The screenshot displays the configuration interface for the VPLUS system, specifically the Oil Cooling Selection screen. The interface is organized into several panels:

- Compressor:** Includes dropdown menus for Compressor (VSS), Model (451), and Refrigerant (R717).
- Compressor Control:** Features checkboxes for Suction Pressure Control, Process Control, Discharge Pressure Control, and radio buttons for Temperature and Pressure. A "# Controllers" field is present.
- Optional Function Selection:** Includes checkboxes for Compressor VFD, Oil Restriction Solenoid, and Superheat (Suction and Discharge Superheat Monitors).
- Condenser Control:** Includes checkboxes for Ambient Sensor, Wetbulb Sensor, and VFD Fan.
- Touchscreen:** Contains buttons for Calibrate and Washdown, and checkboxes for Screen Saver and Display Background Image.
- Oil Pump:** Offers radio button options for No Pump, Cycling, and Full Time.
- Oil Cooling:** Provides radio button options for Thermosyphon, H2O Oil Cooler, Liquid Injection (with sub-options for Solenoids and Motorized Valve), Remote Oil Cooler, and VFD Fan.
- Motor Current Device:** Includes radio buttons for Current Transformer and 4-20ma Transmitter.
- Alarms and Trips:** Features a checkbox for Idle Time Trip.
- Daily Auto Backup Settings:** Includes a Time field with Hour (12) and Minute (0) inputs, and an AM/PM dropdown.

At the bottom, a page navigation bar shows pages 1 through 8, with page 2 selected. "Apply" and "Close" buttons are also visible.

Figure B-26. VPLUS Oil Cooling Selection

# Appendix B • Vission 20/20 Application Procedures

## Step 3: Setup and selection of VPLUS / Motorized Valve Configuration.

The oil cooling VPLUS control parameters must now be setup. Navigate to the last page of the Compressor Control settings page. Setup the Motorized Control Valve setting as show below in Figure B-27.

- Setpoint : 135 deg F.
- Motorized Valve Control: P = 25.0 I = 1.0 D = 4.0

- Minimum Valve Open Percent = De-selected.
- Avg. with Oil Manifold Temperature = De-selected.
  - This selection should be determined by the operator through testing.
- Oil Separator Temp. Override = 100 deg F.

Depending upon the size of the oil separator, the P term may have to be adjusted to give proper response of the 4-20ma signal to the VFD for the VPLUS motor.

The screenshot displays the 'Motorized Valve Control' configuration page. The top status bar shows 'Suction Pressure 1', 'Stopped', and '-84.7 Psig Δ'. The main configuration area includes:

- Liquid Injection:** Liquid Inj. Setpoint (135.0 °F), Oil Sep. Temp. Override (100.0 °F).
- Motorized Valve Control:** P (25.0), I (1.0), D (4.0). Checkboxes for 'Avg. With Oil Manifold Temperature' (unchecked) and 'Minimum Valve Open %' (unchecked, set to 42.5 %).
- Dual Liquid Injection:** Valve Loss (30.0 Psig), Safety Loss (5.0 Psig), Slide % (70 %), Liquid Pressure, Switch Pressure, and Orifice Loss fields.
- Port Selection:** Radio buttons for Low-Medium (selected), Low-High, and Medium-High.

The right sidebar contains control buttons: Capacity Slide (0.0 %), Volume Slide (0.0 %), Stop, Remote Lock Out, Alarm Reset, and Unit Start. It also displays real-time data for Suction Press Control (Setpoint 20.0 Psig), Suction (Press 30.0 "Hg, Temp 465.7 °F), Discharge (Press 108.9 Psig, Temp 141.2 °F), Discharge : Suction (Press Ratio -2.5), Oil (Press Diff 461.5 Psig, Filter Diff -0.2 Psig, Inj Temp 118.8 °F, Sep Temp 76.3 °F), and Motor (Amperage 0.0 Amps).

The bottom status bar includes navigation buttons (Maintenance, User Access, Log off, Help), system messages ('No Scheduled Maintenance', 'No Alarm/Trips Present'), and user information (User: admin, 01/01/2002 11:28:31, Run Hours: 0).

Figure B-27. VPLUS / Motorized Valve Control PID Parameter Setup

## Appendix B • Vission 20/20 Application Procedures

### VPLUS (DC Motor) Setup Procedure for 20/20 Panel

#### INTRODUCTION

This document provides guidelines to setup a DC Motor VPLUS oil cooling system control on the Vission 20/20 panel.

#### SCOPE

The Vilter™ standard VPLUS oil cooling system uses a mini-temperature controller to monitor both discharge and oil injection temperature, averages those temperatures and compares the average to a setpoint. Based on the error from the setpoint, the temperature controller then sends a varying 4-20ma signal to a Dart speed

control board – which varies the speed of a DC motor. The speed of the motor controls the amount of liquid refrigerant that is injected into the compressor to provide oil cooling.

The Vission 20/20 has oil cooling controller algorithms built into the program, and therefore allows for removal of the temperature controller from the VPLUS panel. This document provides instructions to help setup the Vission 20/20 for VPLUS control.

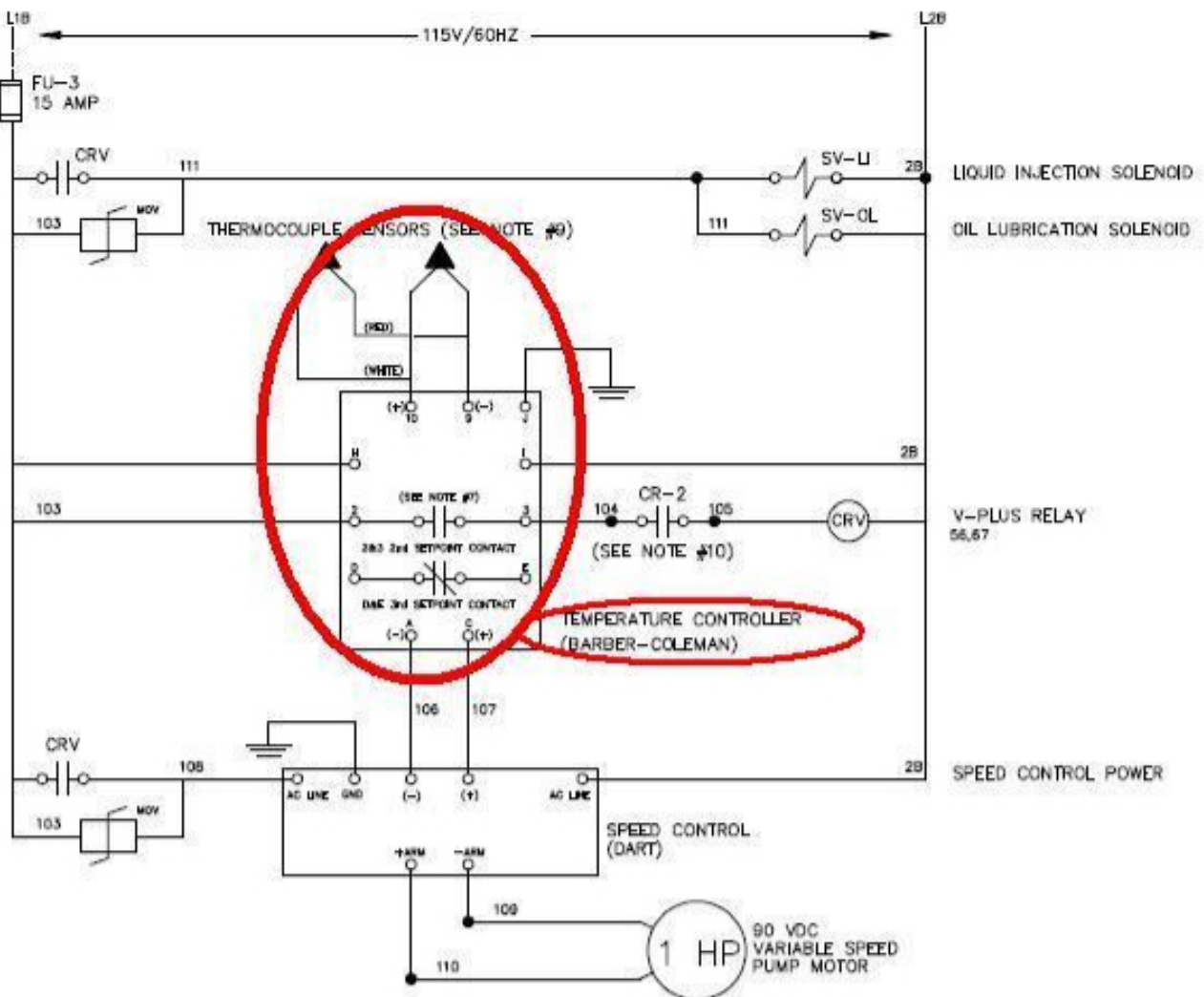

Figure B-28. Standard VPLUS Oil Cooling System Wiring (Eliminating Temperature Controller)

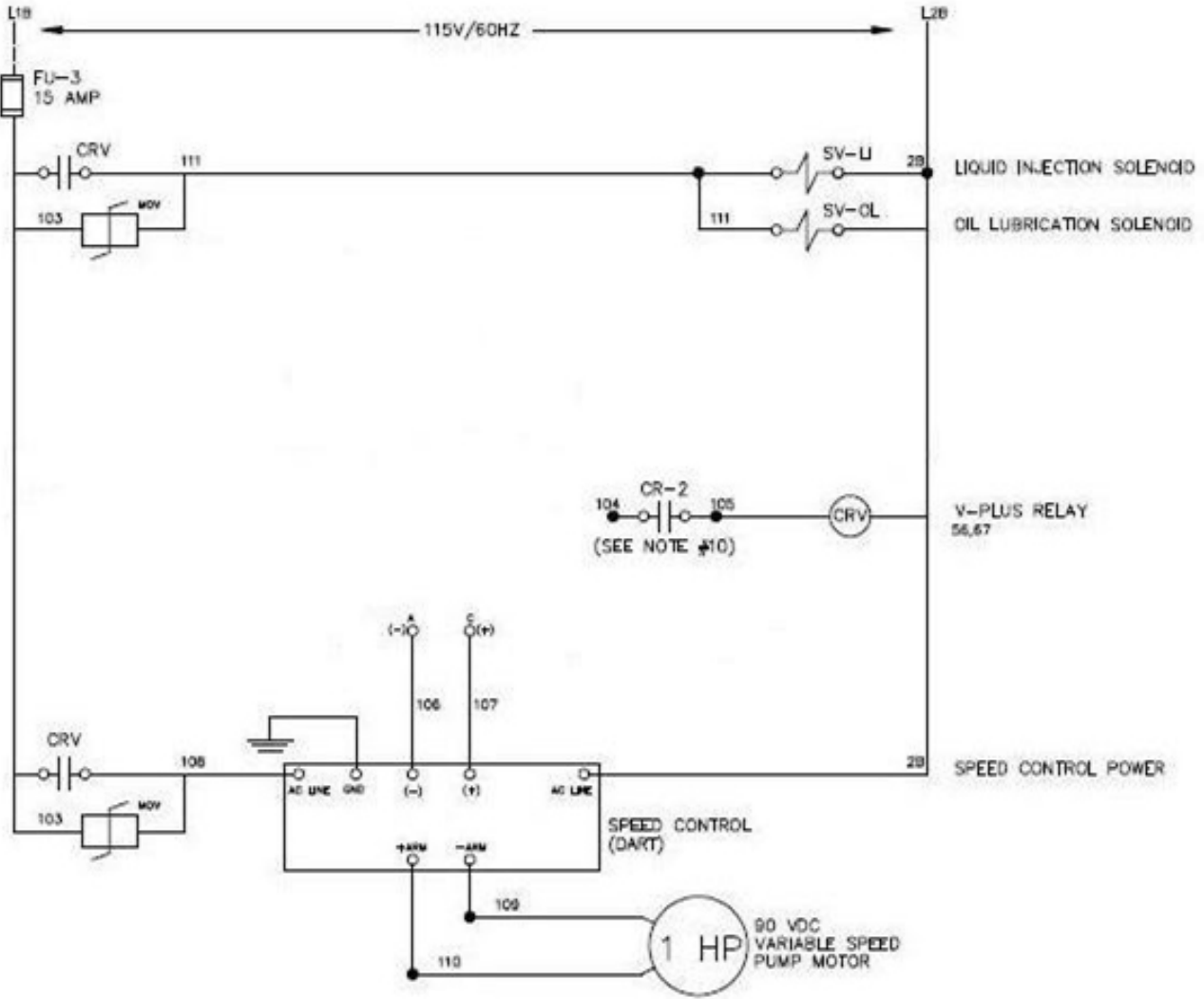

Figure B-29. Temperature Controller Wiring Removed

After removing the temperature controller wiring, the wiring diagram will look like Figure B-29.

## Appendix B • Vission 20/20 Application Procedures

### HARDWARE WIRING

Interconnect wiring between the Vission 20/20 panel and the VPLUS panel now needs to be done.

1. First make sure that the VPLUS panel and the Vission 20/20 panel control power comes from the same source.
2. Next, the Vission 20/20 analog output card must be wired to the Dart speed controller board. The analog output that is used for this is AO#4, see Figure B-30. Wires from AO#4 will land on wires 106 and 107, see Figure B-29.

3. Finally, the VPLUS relay (CRV) shown in Figure B-29 must also be wired to the Vission 20/20. This relay will be controlled by the Vission 20/20 digital output (board #2, output #5) – the liquid injection solenoid output. Run a wire from terminal 25 in the 20/20 panel to terminal 104 in the VPLUS panel, see Figure B-31.

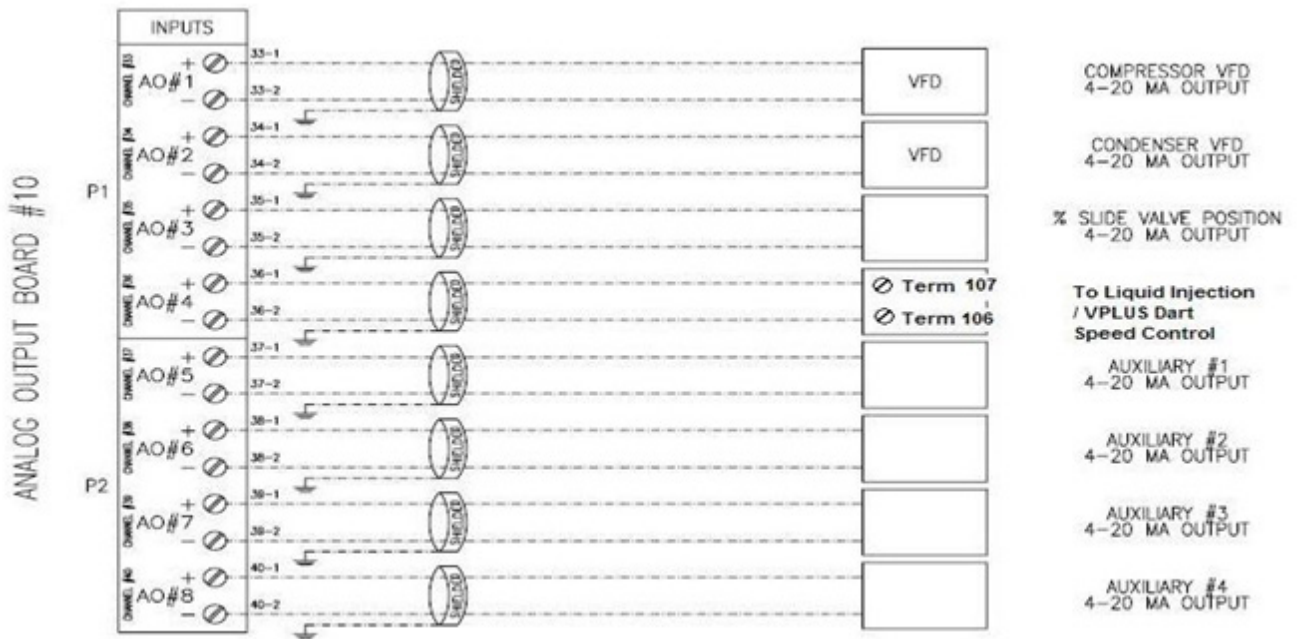

Figure B-30. Analog Output Card Wiring to VPLUS Dart Speed Controller (Wire 106 and 107)



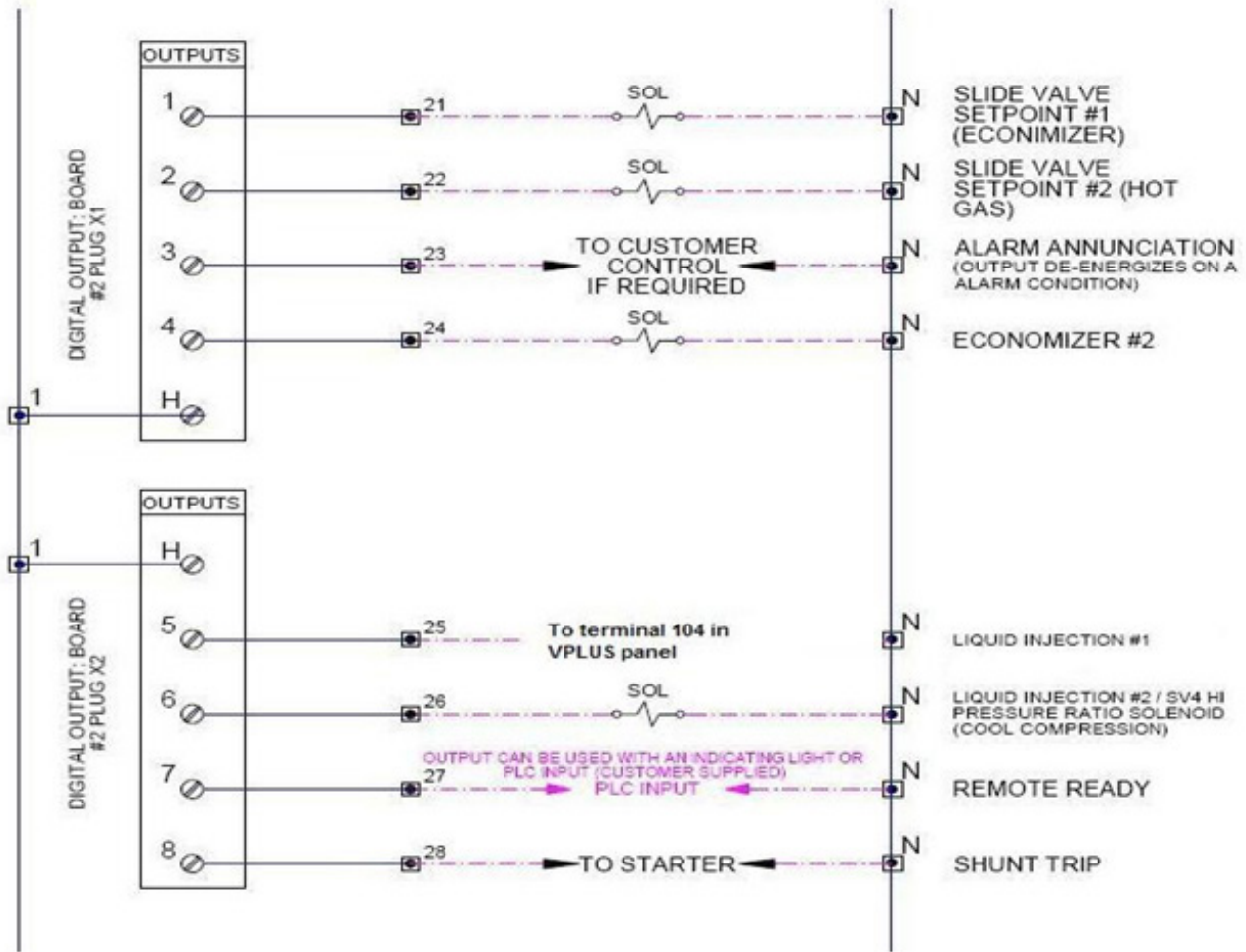

Figure B-31. Digital Output Card Wiring to VPLUS CRV Relay Terminal 104



## Appendix B • Vission 20/20 Application Procedures

### VISSION 20/20 SOFTWARE SETUP

#### Step 1: Configuration Screen Selection of Installed Boards

Logon and navigate to the Configuration screen, page number 6. Insure that all boards that are physically

installed into the 20/20 panel have been selected or “checked”. You should have the additional board #10 installed (analog output board) and selected.

Continue to step 2.

**I/O Configuration**

Digital Output 1

OPEN			
O	O	O	
			X
4	3	2	1

Analog Input 1

OPEN			
O			O
	X	X	
4	3	2	1

Digital Output 2

OPEN			
O	O		O
		X	
4	3	2	1

Analog Input 2

OPEN			
O			
	X	X	X
4	3	2	1

Digital Input 1

OPEN			
O	O		
		X	X
4	3	2	1

Analog Input 3

OPEN			
	O	O	O
X			
4	3	2	1

Digital Input/Output 1

OPEN			
O		O	O
	X		
4	3	2	1

Analog Input 4

OPEN			
	O	O	
X			X
4	3	2	1

Digital Input/Output 2

OPEN			
O		O	
	X		X
4	3	2	1

Analog Output

OPEN			
	O		O
X		X	
4	3	2	1

Page 1 2 3 4 5 6 7 8 Apply Close

Figure B-32. Selection of Installed Boards (Configuration Screen – Page 6)

## Appendix B • Vission 20/20 Application Procedures

### Step 2: Setup and selection of Oil Cooling from page 2 of the Configuration screen

The oil cooling VPLUS algorithm must be enabled from the configuration screen. The algorithm used for this is the same one that is used to control the oil cooling motorized positioning valve. Navigate to page 2 of the Configuration screen. In the middle column, towards the bottom of page 2 are the Oil Cooling selections, see Figure B-33. Select “Liquid Injection” method and then select the “Motorized Valve” selection. Note that by selecting the positioning valve algorithm, the speed of

the VPLUS motor is being controlled based on the discharge temperature only (by default), but the settings to be established in step 3 will provide additional control variables.

Continue to step 3.

The screenshot displays the configuration interface for VPLUS Oil Cooling. The interface is organized into several sections:

- Compressor:** VSS (dropdown), Model 451 (dropdown), Refrigerant R717 (dropdown).
- Compressor Control:** Suction Pressure Control (checked, # Controllers: 2), Process Control (unchecked, # Controllers: 1), Temperature (selected), Pressure (unselected), Discharge Pressure Control (unchecked, # Controllers: 1).
- Optional Function Selection:** Compressor VFD (unchecked), Oil Restriction Solenoid (unchecked).
- Superheat:** Suction Superheat Monitor (unchecked), Discharge Superheat Monitor (unchecked).
- Condenser Control:** Ambient Sensor (unchecked), Wetbulb Sensor (unchecked), VFD Fan (unchecked).
- Touchscreen:** Calibrate, Washdown, Screen Saver (checked), Display Background Image (checked).
- Oil Pump:** No Pump (selected), Cycling, Full Time.
- Oil Cooling:** Thermosyphon, H2O Oil Cooler, Liquid Injection (selected), Solenoids, Motorized Valve (selected), Remote Oil Cooler, VFD Fan (unchecked).
- Motor Current Device:** Current Transformer (selected), 4-20ma Transmitter.
- Alarms and Trips:** Idle Time Trip (unchecked).
- Daily Auto Backup Settings:** Time: Hour 12, AM, Minute 0.

At the bottom, there is a page navigation bar with buttons for pages 1 through 8, with page 2 highlighted. There are also 'Apply' and 'Close' buttons.

Figure B-33. Oil Cooling Selection for VPLUS Oil Cooling

## Appendix B • Vission 20/20 Application Procedures

### Step 3: Setup and selection of VPLUS / Motorized Valve Control PID parameters.

The oil cooling VPLUS control parameters must now be setup. Navigate to the last page of the Compressor Control settings page. Setup the Motorized Control Valve setting as show in Figure B-34.

- Setpoint : 135 deg F.
- Motorized Valve Control: P = 25.0 I = 1.0 D = 4.0
- Minimum Valve Open Percent = De-selected.
- Avg. with Oil Manifold Temperature = De-selected.
  - This selection should be determined by the operator through testing. In some applications, selecting this option can provide a more stable

control of the VPLUS motor, compared to only using discharge temperature to control the motor.

- Oil Separator Temp. Override = 100 deg F.

Depending upon the size of the oil separator, the P term may have to be adjusted to give proper response of the 4-20ma signal to the Dart Speed controller board for the VPLUS motor.

The screenshot displays the 'Liquid Injection' control interface. At the top, it shows 'Suction Pressure 1' as 'Stopped' at '-84.7 Psig Δ'. The main control area includes:

- Liquid Injection:** Liquid Inj. Setpoint (135.0 °F), Oil Sep. Temp. Override (100.0 °F).
- Motorized Valve Control:** P (25.0), I (1.0), D (4.0). Checkboxes for 'Avg. With Oil Manifold Temperature' (unchecked) and 'Minimum Valve Open %' (42.5%, unchecked).
- Dual Liquid Injection:** Valve Loss (30.0 Psig), Safety Loss (5.0 Psig), Slide % (70%), Liquid Pressure, Switch Pressure, and Orifice Loss fields.
- Port Selection:** Radio buttons for Low-Medium (selected), Low-High, and Medium-High.

On the right side, there are control slides for 'Capacity Slide' (0.0%) and 'Volume Slide' (0.0%), along with buttons for 'Stop', 'Remote Lock Out', 'Alarm Reset', and 'Unit Start'. Below these are status indicators for 'Suction Press Control' (Setpoint 20.0 Psig), 'Suction' (Press 30.0 "Hg, Temp 465.7 °F), 'Discharge' (Press 108.9 Psig, Temp 141.2 °F), and 'Discharge : Suction' (Press Ratio -2.5). The bottom status bar shows 'Oil' (Press Diff 461.5 Psig, Filter Diff -0.2 Psig, Inj Temp 118.8 °F, Sep Temp 76.3 °F) and 'Motor' (Amperage 0.0 Amps). Maintenance and alarm status are shown as 'No Scheduled Maintenance' and 'No Alarm/Trips Present'. User information includes 'User admin', '01/01/2002 11:28:31', and 'Run Hours 0'.

Figure B-34. Setting the VPLUS / Motorized Valve Control PID Parameters

# Appendix B • Vission 20/20 Application Procedures

## Vibration Monitoring Setup Procedure

### INTRODUCTION

Follow these steps to setup the vibration monitoring system on the unit.

All electrical wiring and boards must be installed before proceeding with this procedure.

#### NOTE

This procedure will only show the steps to set up one vibration monitoring set (one Vibration Sensor and one Transmitter).

### Step 1: Select Analog Input Boards

From the Configuration screen, page 6, select the number of Analog Input boards installed. In this case, an additional analog input board was installed, Analog Input 3.

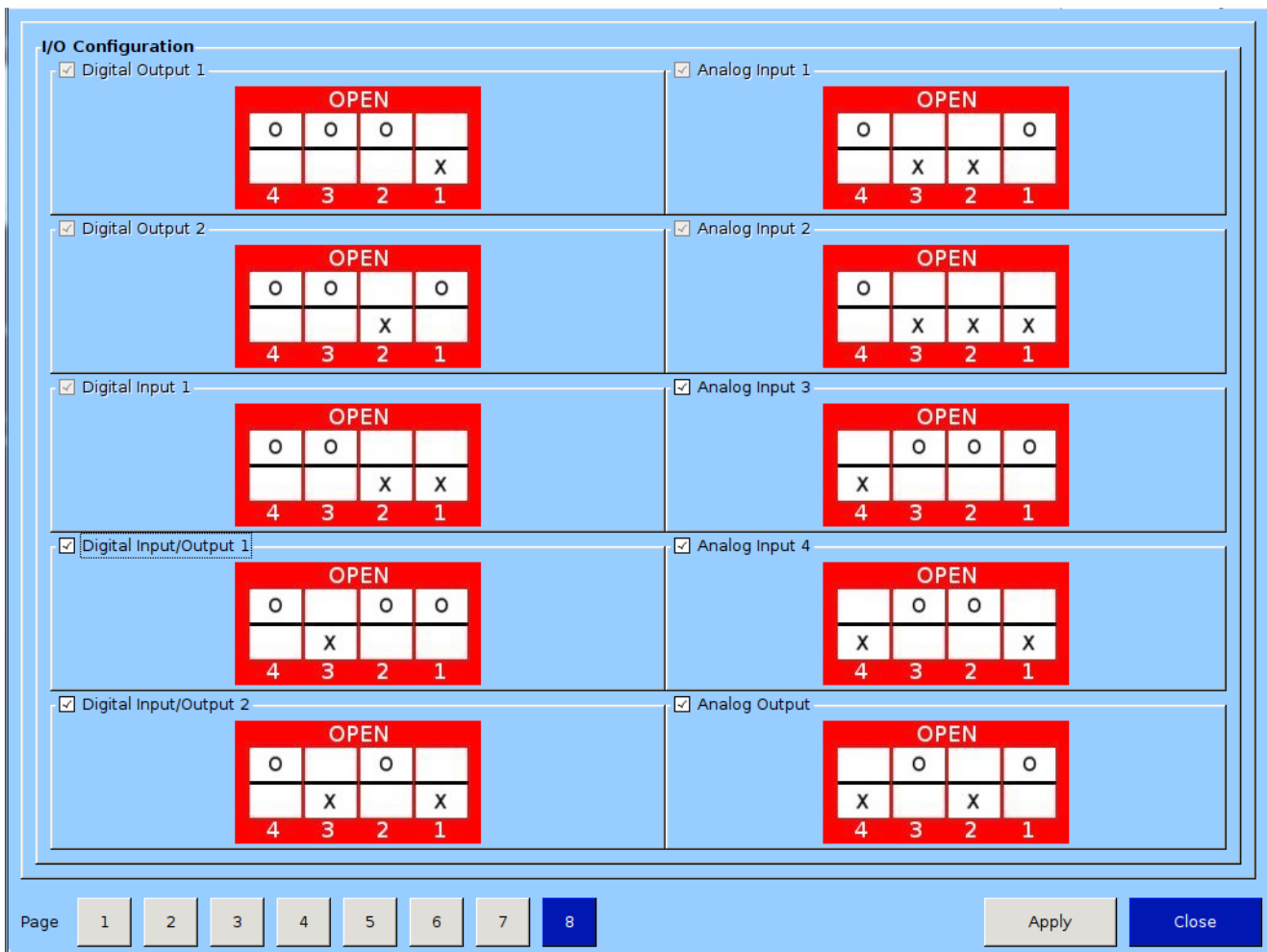

Figure B-35. Vibration Monitoring - Step 1 (Configuration Screen, Page 6)

## Appendix B • Vission 20/20 Application Procedures

### Step 2: Configure Analog Auxiliary Inputs

From the Configuration screen, page 4, select the number of Analog Auxiliary Inputs. In this case, since the Vibration Transmitter outputs two signals, a 4-20 mA Fault Detector signal and a 4-20 mA Overall Vibration signal, two auxiliary inputs are needed, Input #1 and Input #2.

In the Set Name field, add a description for each auxiliary input. In this case, Input #1 is “overall vibration” and Input #2 is “Fault Detector”. Adding in the names here will now allow other associated name fields to be populated as shown in Step 3.

**Analog Auxiliaries**

**Analog Inputs**

<input checked="" type="checkbox"/> Enable Input #1	Set Name: overall vibration	<input type="checkbox"/> Enable Input #9	Set Name: Analog Aux in 9
<input checked="" type="checkbox"/> Enable Input #2	Set Name: Fault Detector	<input type="checkbox"/> Enable Input #10	Set Name: Analog Aux in 10
<input type="checkbox"/> Enable Input #3	Set Name: Analog Aux in 3	<input type="checkbox"/> Enable Input #11	Set Name: Analog Aux in 11
<input type="checkbox"/> Enable Input #4	Set Name: Analog Aux in 4	<input type="checkbox"/> Enable Input #12	Set Name: Analog Aux in 12
<input type="checkbox"/> Enable Input #5	Set Name: Analog Aux in 5	<input type="checkbox"/> Enable Input #13	Set Name: Analog Aux in 13
<input type="checkbox"/> Enable Input #6	Set Name: Analog Aux in 6	<input type="checkbox"/> Enable Input #14	Set Name: Analog Aux in 14
<input type="checkbox"/> Enable Input #7	Set Name: Analog Aux in 7	<input type="checkbox"/> Enable Input #15	Set Name: Analog Aux in 15
<input type="checkbox"/> Enable Input #8	Set Name: Analog Aux in 8	<input type="checkbox"/> Enable Input #16	Set Name: Analog Aux in 16

Page: 1 2 3 **4** 5 6      Apply      Close

Figure B-36. Vibration Monitoring - Step 2 (Analog Auxiliary Screen, Page 4)

# Appendix B • Vission 20/20 Application Procedures

## Step 3: Calibrate Instruments (1 of 2)

From the Instrument Calibration screen, page 4, with Input #1 and Input #2 configured, the Set Names will be shown in Aux 1 and Aux 2 tabs.

To set up Aux 1, in the Device Calibration window, select “Other” from the drop-down menu and enter the desired unit, in this case, “in,sec”. Then add in the Min and Max values, in this case, “0.0 in,sec” and “1.0 in,sec”, respectively. Since the Range for the device (Vibration Transmitter) is 4-20 mA, “0.0 in,sec” will correspond to 4 mA and “1.0 in,sec” will correspond to 20 mA. No further set up is required, other than what has been explained.

The screenshot displays the Vission 20/20 Instrument Calibration interface. At the top, it shows 'Suction Pressure 1' (Stopped) and '6.6 Psig Δ'. The main area is divided into 'Analog Inputs' and 'Device Calibration'.

**Analog Inputs:**

- Aux 1 : overall vibration
- Aux 2 : Fault Detector
- Aux 3 : Analog Aux in 3
- Aux 4 : Analog Aux in 4
- Aux 5 : Analog Aux in 5
- Aux 6 : Analog Aux in 6
- Aux 7 : Analog Aux in 7
- Aux 8 : Analog Aux in 8

**Device Calibration:**

- I/O:** A/D bit Value: 2279; Calibrated Value: 0.4 in,sec
- Units:** Other (selected); Enter Desired Unit: in,sec
- Min:** 0.0 in,sec
- Max:** 1.0 in,sec
- Channel Calibration:** Offset: 0.0; Adjustment: [empty]; Total Offset: 0.0
- Range:** I/O jumpers selection: 4ma - 20ma; Min: 4.0 ma; Max: 20.0 ma

**Capacity Slide:** 0.0 %; Stop; Remote Lock Out

**Volume Slide:** 0.0 %; Alarm Reset; Unit Start

**Suction Press Control:** Setpoint 20.0 Psig

**Suction:** Press 26.6 Psig; Temp 55.0 °F

**Discharge:** Press 124.2 Psig; Temp 71.5 °F

**Discharge : Suction:** Press Ratio 3.4

**Oil:** Press Diff 46.2 Psig; Filter Diff 9.5 Psig; Inj Temp 115.3 °F; Sep Temp 110.3 °F

**Motor:** Amperage 0.0 Amps

**Page:** 1, 2, 3, 4 (selected), 5, 6; Menu

**Maintenance:** No Scheduled Maintenance; No Alarm/Trips Present

**User Access:** Log off; Help

**Panel 1:** User admin; 11/07/2014 14:08:26; Run Hours 0

Figure B-37. Vibration Monitoring - Step 3 (Instrument Calibration, Page 4)

## Appendix B • Vission 20/20 Application Procedures

### Step 4: Calibrate Instruments (2 of 2)

Now that calibrating Aux 1 is complete, continue to calibrate Aux 2.

To set up Aux 2, in the Device Calibration window, select “Other” from the drop-down menu and enter the desired unit, in this case, “PV g”.

Then add in the Min and Max values, in this case, “0.0 PV g” and “50.0 PV g”, respectively. Since the Range for the device (Vibration Transmitter) is 4-20 mA, “0.0 PV g” will correspond to 4 mA and “50.0 PV g” will correspond to 20 mA. No further set up is required, other than what has been explained.

#### NOTE

“PV g” is “PeakVue® g”. This unit is in no relation to g as in g-force. This unit is used to describe the frequency of stress waves caused by defects in the moving component. So a high PV g value, indicates a major defect in the component (i.e. a crack in the race of a roller bearing).

Figure B-38. Vibration Monitoring - Step 4 (Instrument Calibration, Page 4)



# Appendix B • Vission 20/20 Application Procedures

## Step 5: Set Up Alarms and Trips

From the Auxiliary I/O screen, page 3, setup the alarms and trips for Aux 1 and Aux 2.

In the example shown in Figure B-39, for Aux 1, the “Alarm Only” is selected. The “Low Alarm” setpoint is set to “-1.0 in,sec” so that the low alarm will not activate. The “High Alarm” is set to “1.0 in,sec” so when that setpoint is reached, the alarm will activate. The “Low Trip” and “High Trip” setpoints are left at “0.0 in,sec” since the “Alarm Only” is selected. The “Delay” is set to “5 sec”.

In the example shown in Figure B-39, for “Aux 2: Fault Detector”, the alarm and trip are both selected with the selection of “Both” from the drop-down menu. The “Low Alarm” setpoint is set to “-10.0 PV g” so that the low alarm will not activate. The “High Alarm” is set to “20.0 PV g” so when that setpoint is reached, the alarm will activate. The “Low Trip” is set to “-10.0 PV g” so that the low trip will not activate. The “High Trip” is set to “40.0 PV g” so when that setpoint is reached, the trip will activate. The “Delay” is set to “60 sec”.

### NOTE

The “Delay” setpoint is the amount of time monitored when the setpoint is reached. For example, if the setpoint continues to be equal or greater past the “Delay” time, then the alarm or trip will activate.

The screenshot displays the 'Auxiliary I/O' screen for 'Suction Pressure 2'. The main status bar shows 'Stopped' and '-6.9 Psig Δ'. On the right, there are 'Capacity Slide' (3.5%) and 'Volume Slide' (0.7%) controls, along with 'Stop', 'Remote Lock Out', 'Alarm Reset', and 'Unit Start' buttons.

The 'Analog Inputs' section contains six panels for different auxiliary sensors:

- Aux1: overall vibration:** Alarm/Trip: Alarm Only; Low Alarm: -1.0 in,sec; High Alarm: 1.0 in,sec; Low Trip: 0.0 in,sec; High Trip: 0.0 in,sec; Delay: 5 sec.
- Aux2: Fault Detector:** Alarm/Trip: Both; Low Alarm: -10.0 PV g; High Alarm: 20.0 PV g; Low Trip: -10.0 PV g; High Trip: 40.0 PV g; Delay: 60 sec.
- Analog Aux in 4:** Alarm/Trip: Neither; Low Alarm: 0.0 °F; High Alarm: 0.0 °F; Low Trip: 0.0 °F; High Trip: 0.0 °F; Delay: 5 sec.
- Analog Aux in 5:** Alarm/Trip: Neither; Low Alarm: 0.0 °F; High Alarm: 0.0 °F; Low Trip: 0.0 °F; High Trip: 0.0 °F; Delay: 5 sec.
- Analog Aux in 3:** Alarm/Trip: Neither; Low Alarm: 0.0 °F; High Alarm: 0.0 °F; Low Trip: 0.0 °F; High Trip: 0.0 °F; Delay: 5 sec.
- Analog Aux in 6:** Alarm/Trip: Neither; Low Alarm: 0.0 °F; High Alarm: 0.0 °F; Low Trip: 0.0 °F; High Trip: 0.0 °F; Delay: 5 sec.

At the bottom, there are navigation buttons (Page 1-7, Menu), system status (Maintenance, User Access, Log off, Help), and a summary table:

No Scheduled Maintenance	User	admin
No Alarm/Trips Present	07/04/2017	02:00:28
	Run Hours	15

On the right side, there are several data panels:

- Suction Press Control:** Setpoint 30.0 Psig
- Suction:** Press 23.1 Psig, Temp 43.1 °F
- Discharge:** Press 147.4 Psig, Temp 175.7 °F
- Discharge : Suction:** Press Ratio 4.3
- Oil:** Press Diff 141.7 Psig, Filter Diff 9.9 Psig, Inj Temp 104.6 °F, Sep Temp 110.3 °F
- Motor:** Amperage 1.4 Amps

Figure B-39. Vibration Monitoring - Step 5 (Auxiliary I/O Screen, Page 3)



## Appendix B • Vission 20/20 Application Procedures

### Step 6: Trending

To view the trend data for the vibration monitoring devices Aux 1 and Aux 2; from the Trend screen, go to the Trend Setup screen by pressing the “Setup” button, see Figure B-40.

From the Trend Setup screen, in Figure B-41, select “Auxiliary Input #1” and “Auxiliary Input #2”. Then press “OK” to return to the Trend screen.

Select the corresponding trending line colors for “Auxiliary Input #1” and “Auxiliary Input #2” from the drop-down menus. There are four trending colors to choose from; red, blue, green and yellow.

Then press “Start” to start viewing the trending data of Auxiliary Input #1 and #2.

#### NOTE

Only a maximum of 10 devices can be selected from the Trend Setup screen and only a maximum of 4 devices can be viewed at one time on the Trend screen chart.

The screenshot shows the 'Trend Setup' screen for 'Suction Pressure 1'. The top status bar displays 'Stopped' and '23.7 Psig Δ'. The 'Trend Setup' panel on the left has a grid of checkboxes for various parameters. The right panel features 'Capacity Slide' and 'Volume Slide' controls, along with 'Stop', 'Remote Lock Out', 'Alarm Reset', and 'Unit Start' buttons. The bottom right corner shows a summary of system parameters.

Parameter	Value
Suction Press Control Setpoint	20.0 Psig
Suction Press	43.7 Psig
Suction Temp	26.5 °F
Discharge Press	177.9 Psig
Discharge Temp	-3.7 °F
Discharge : Suction Press Ratio	3.3
Oil Press Diff	118.9 Psig
Oil Filter Diff	5.5 Psig
Oil Inj Temp	78.6 °F
Oil Sep Temp	191.4 °F
Motor Amperage	0.0 Amps

Figure B-40. Vibration Monitoring - Step 6 (Trend Screen)

### Contents

Introduction .....	C-3
Networking .....	C-3
Communication Wire.....	C-3
Ethernet Cable Specifications.....	C-3
RS-422/485 Cable Specifications.....	C-3
Network Topology .....	C-7
RS422/RS485 Networking Topology .....	C-7
Using A Network Isolator / Repeater .....	C-7
Using Vpn3485ms Device As A Network Convertor .....	C-7
Using The Device As A Network Isolator/Repeater .....	C-8
Ethernet Network Topology .....	C-10
Additional Network Configurations For Access Via Internet .....	C-11
Sample Setup Using A Wireless Router .....	C-13
VNC Clients.....	C-13
Accessing VNC from Web Browser .....	C-14
PLC Remote Compressor Control of Vission 20/20.....	C-19
Remote Compressor Control Via Communications.....	C-20
Configuration Screen Setup For Remote Control Through Communications.....	C-24
Introducing The Remote Lock Button And Restart On Power Failure Selection .....	C-24
Common Register Setup For Controlling The Vission 20/20 (Compressor Control) Via Communications	C-25
Control Scenario .....	C-28
Remote Monitoring .....	C-28
Communication Port Setup.....	C-28



## Appendix C • Remote Control and Monitoring of Vission 20/20 Panel

---

### INTRODUCTION

This document provides the reader with guidelines to successfully communicate and integrate with the Vilter™ Vission 20/20™ control panel.

### NETWORKING

The Vission 20/20 directly supports two different hardware networks;

- a. Ethernet – supporting Modbus TCP and Ethernet I/P protocols
- b. RS485 – supporting serial Modbus RTU protocol

### COMMUNICATION WIRE

For any communication network to work properly, it is important to use the proper wire.

#### Ethernet Cable Specifications

Category 6 cable is recommended. Many installations are now using gigahertz switches, and category 6 provides greater immunity to signal crosstalk.

#### RS-422/485 Cable Specifications

The following cables are recommended for RS-422/485 serial communications. Although you may elect to use other cables, keep in mind that low capacitance (less than 15 pF/ft.) is important for high-speed digital communication links. The cables listed below are all 24-gauge, 7x32 stranded, with 100-ohm nominal impedance and a capacitance of 12.5 pF/ft.

Select from the following four-, three-, and two-pair cables, depending on your application needs. All will yield satisfactory results. It is recommended that you choose a cable with one more pair than your application requires.

Use one of the extra wires, rather than the shield, for the common.

#### Four-Pair

- Belden P/N 8104 (with overall shield)
- Belden P/N 9728 (individually shielded)
- Belden P/N 8164 (individually shielded with overall shield)
- Manhattan P/N M3477 (individually shielded with overall shield)
- Manhattan P/N M39251 (individually shielded with overall shield)

#### Three-Pair

- Belden P/N 8103 (with overall shield)
- Belden P/N 9730 (individually shielded)
- Belden P/N 8163 (individually shielded with overall shield)
- Manhattan P/N M3476 (individually shielded with overall shield)
- Manhattan P/N M39250 (individually shielded with overall shield)

#### Two-Pair

- Belden P/N 8102 (with overall shield)
- Belden P/N 9729 (individually shielded)
- Belden P/N 8162 (individually shielded with overall shield)
- Manhattan P/N M3475 (individually shielded with overall shield)
- Manhattan P/N M39249 (individually shielded with overall shield)

## Appendix C • Remote Control and Monitoring of Vision 20/20 Panel

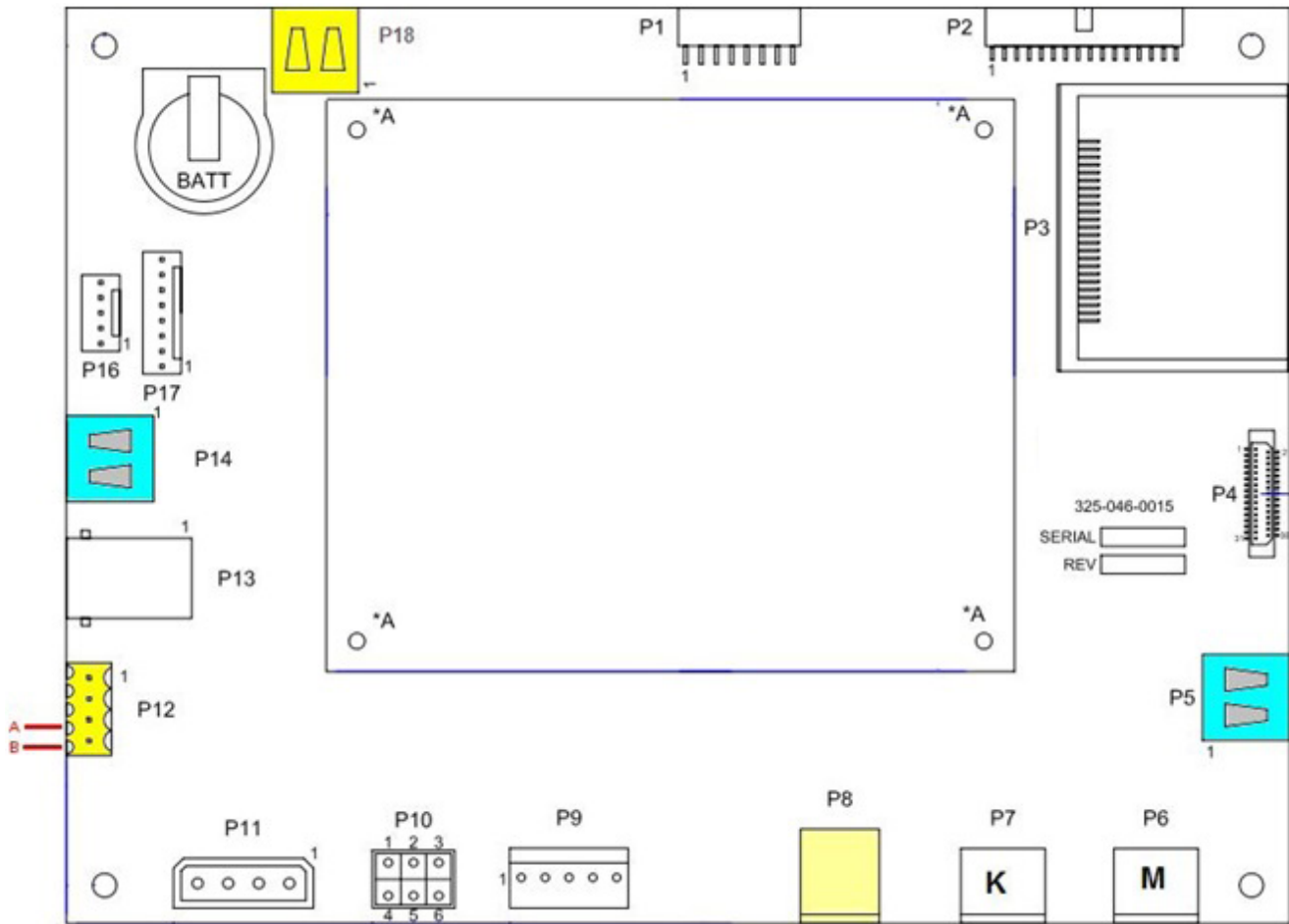

Figure C-1. Serial Communication Ports on Single Board Computer

P12 = RS485 Serial Modbus RTU connector \*

P14, P18 = USB Serial Modbus RTU connectors

P8 = Ethernet RJ45 connector

The 20/20 offers two solutions for serial communications. The first option is connector P12 which uses traditional serial UART hardware. The second option uses the USB ports, P14 or P18. These ports require the use of an inexpensive, industrial USB to RS422/RS485 convertor. Vilter™ can supply these, or you can purchase your own. For serial communications, we recommend using the USB ports, first because of the robustness of the USB ports. They also offer increased speed. The third reason is that computer manufacturers are steering serial network users to move towards using the USB ports for serial communications.

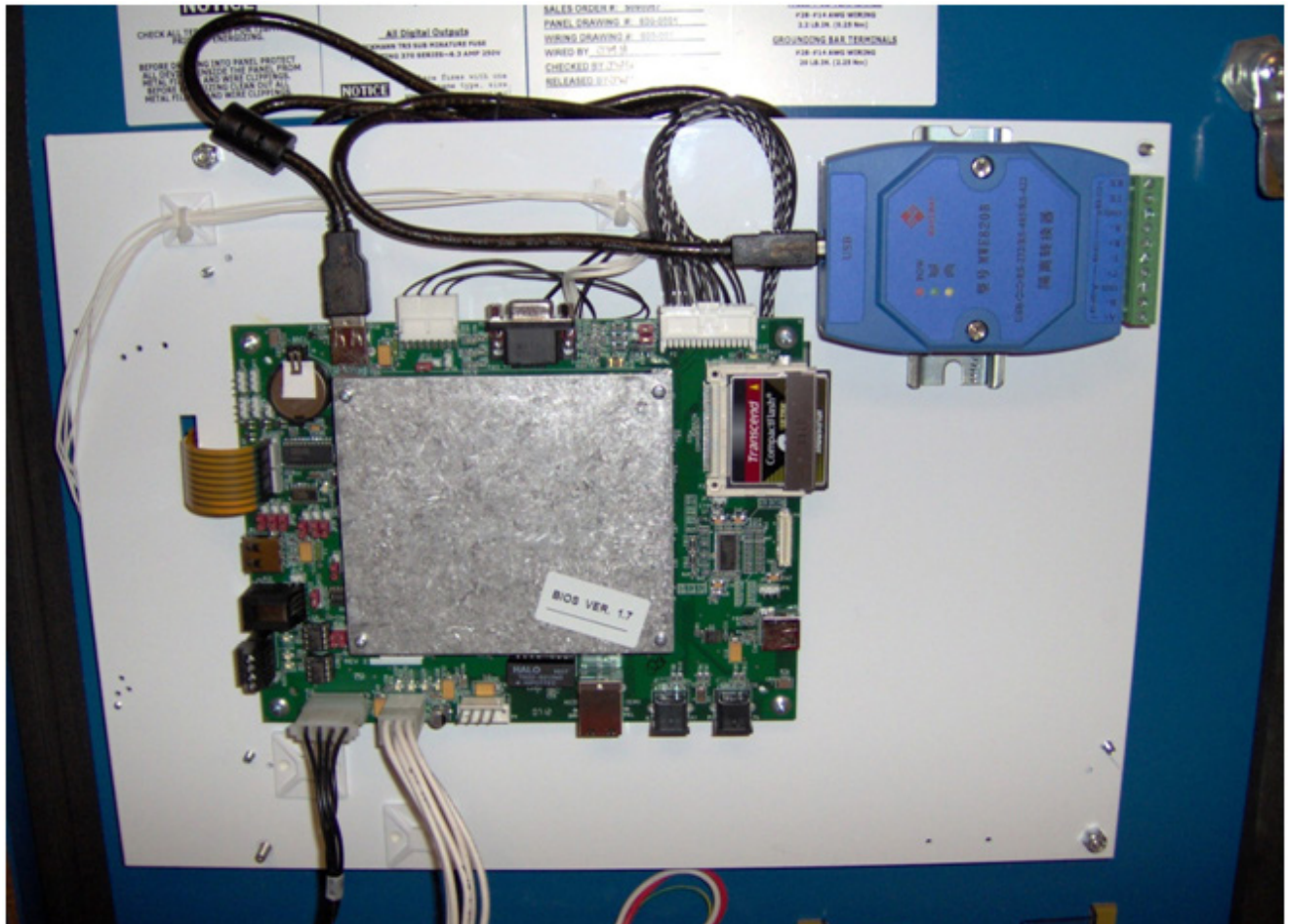

**Figure C-2. Vission 20/20 Single Board Computer with USB to RS422/RS485 Converter (VPN3485C) on USB port P18**

*The above photo shows a typical connection for using one of the USB ports (in this case P18) for Modbus RTU serial communications. The USB port has a USB to RS422/RS485 converter attached to it (VPN 3485C). One side of the converter attaches to the USB port. The green plug of the converter would then be connected to the RS422 or RS485 network (network wiring is not shown).*

## Appendix C • Remote Control and Monitoring of Vission 20/20 Panel

The screenshot displays the configuration interface for the Vission 20/20 panel, organized into several sections:

- Compressor Identification:** Includes fields for Name, Panel ID (set to 1), Temp. Units (°F), Press. Units (Psig), Order Num. (1), and Run Hours (0).
- Time:** Offers a 24-hour or 12-hour format (12-hour is selected), and fields for Current time (04:20:57 PM).
- Date:** Fields for Year (2002), Month (01), and Day (07).
- Communications:** The primary section, showing 'Active Remote Control' set to 'Serial'. Under 'On Communication Failure', 'Revert to Local Control' is selected. Checkboxes for 'Direct I/O -> Auto Capacity' and 'Serial (Modbus RTU)' are checked. The 'Serial (Modbus RTU)' section includes: Node Address (1), Port (serial USB), Baud Rate (9600), Data Bits (8), Stop Bits (1), and Parity (Even). The 'Ethernet' section is also checked, with IP Address (192.168.1.90), Subnet Mask (255.255.255.0), Gateway (192.168.1.1), Protocol (Modbus TCP), and Node Address (1).
- VNC Account:** Fields for New Password, Verify New Password, Port Number (5920), and Browser Port Number (5901). An option to 'Enable Web Browser Access' is unchecked.
- Anti-Recycle:** Set to 'Accumulative'.
- Restart on Power Failure:** Options include Always, Never (selected), Timed, Remote Lock Off, and Boot in Remote (Direct I/O).
- Compressor Sequencing:** 'Master' is selected, and a Network Name field is present.
- Language:** Set to 'English'.

At the bottom, there is a 'Page' indicator showing page 1 of 6, and 'Apply' and 'Close' buttons.

Figure C-3. Selecting USB Port for Serial Communication

The Vission 20/20 panel allows designating the USB port to be used for serial Modbus RTU communication from the Configuration screen. A USB device must be plugged into one of the USB ports in order for the “Serial USB” option to appear from the drop-down box.



## Appendix C • Remote Control and Monitoring of Vission 20/20 Panel

### NETWORK TOPOLOGY

#### RS422/RS485 Networking Topology

Many articles have been written about the different topologies of RS422/RS485 networks. Vilter™ recommends that a daisy chain topology be used for any RS422/RS485 network that incorporates a Vilter™ Vission 20/20™ panel as a network slave node. Refer to Figure C-4.

#### USING THE VPN 3485C1 DEVICE AS A NETWORK CONVERTER

Figure C-5 is a typical connection wiring diagram for using the device as an RS422 to RS485 converter/isolator.

#### USING A NETWORK ISOLATOR / REPEATER

The RS422/RS485 repeater/isolator can be used to provide a device on the serial network with isolation. The isolator/repeater suppresses surges that may be present on the network wires, and optically isolates and converts unbalanced lines to balanced lines. It can also act as an RS422 to RS485 converter while providing the same network isolation. Vilter™ stocks a network repeater/isolator for the 20/20 panels – VPN 3485C1.

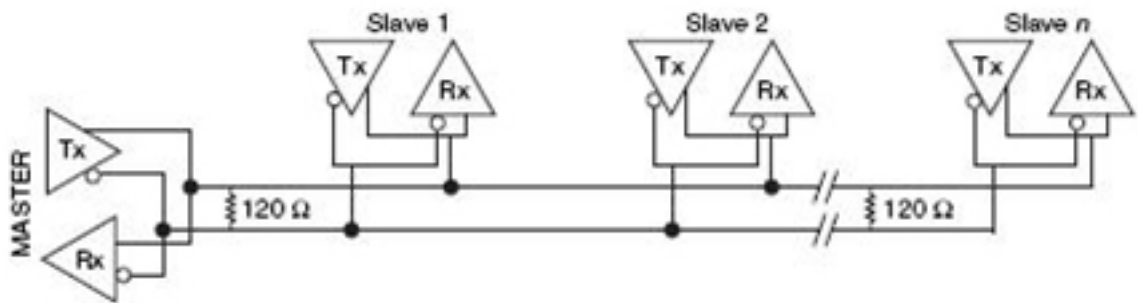

Figure C-4. 2-Wire Multidrop Network Using Terminating Resistors

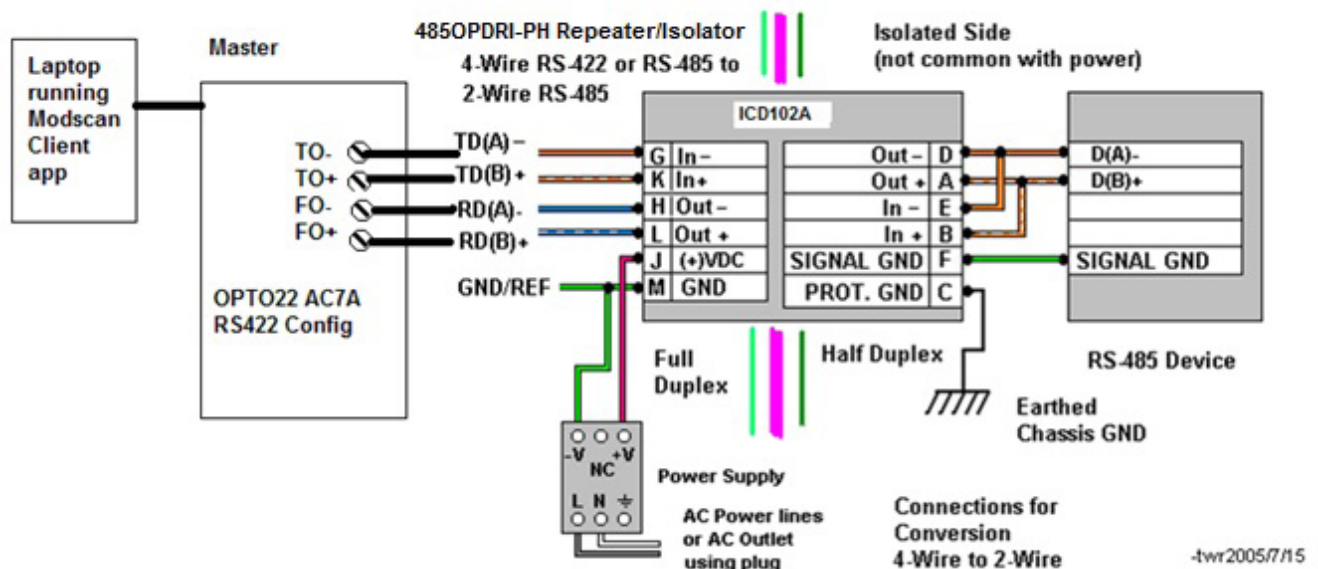

Figure C-5. Wiring Diagram – VPN 3485C1 Device as RS422 to RS485 Converter/Isolator



# Appendix C • Remote Control and Monitoring of Vision 20/20 Panel

## USING THE DEVICE AS A NETWORK ISOLATOR/ REPEATER

(Reference Figure C-6)

1. A DC power supply is required to power the device (+10 VDC to +48 VDC)
2. Dip switches on the side of the device must be configured for the baud rate of the network, see Table C-1.

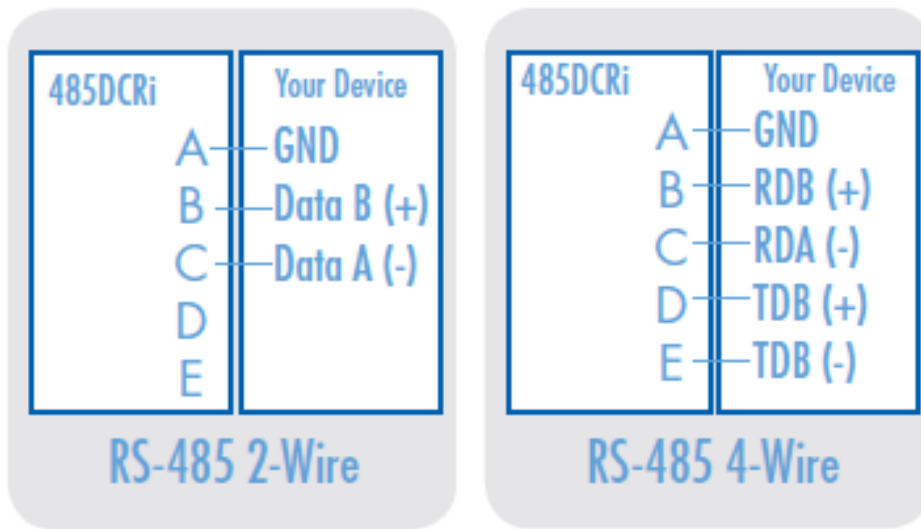

Figure C-6. Wiring Diagram – VPN 3485C1 Device as Network Isolator/Repeater

Table C-1. Dipswitches and Baud Rate Selection

DIP Switch		RS-485 2-Wire				
1	2	3	4	5	6	7
ON	ON	ON	ON	**	**	**
Positions 5-7 are used for termination and biasing Positions 8-12 are used to set the baud rate						

DIP Switch		RS-422/485 4-Wire				
1	2	3	4	5	6	7
**	OFF	OFF	OFF	**	**	**
Position 1 = ON for RS-485 Position 1 = OFF for RS-422 Positions 5-7 are used for termination and biasing Positions 8-12 are used to set the baud rate						

### Switch Selectable

Baud (kbps)	8	8	10	11	12	Timeout (ms)
2.4	ON	OFF	OFF	OFF	OFF	4.37
4.8	OFF	ON	OFF	OFF	OFF	2.03
9.6	OFF	OFF	ON	OFF	OFF	1.02
19.2	OFF	OFF	OFF	ON	OFF	0.37
38.4	OFF	OFF	OFF	OFF	ON	0.27

### Resistor Selectable

Baud (kbps)	8-12	R-11 Value	Timeout (ms)
1.2	OFF	820 K $\Omega$	8.32
57.6	OFF	16 K $\Omega$	0.16
115.2	OFF	8.2 K $\Omega$	0.08
230.4	OFF	4.3 K $\Omega$	0.04
460.8	OFF	2.2 K $\Omega$	0.02

Table C-2. RS422/485 Switch Settings

Communications Mode	Switch			
	1	2	3	4
RS-485 2-Wire Half Duplex	ON	ON	ON	ON
RS-485 4-Wire Full Duplex	ON	OFF	OFF	OFF
RS-422 Full Duplex	OFF	OFF	OFF	OFF



Figure C-7. VPN 3485C1 DIN Rail Mounted

## Appendix C • Remote Control and Monitoring of Vision 20/20 Panel

### ETHERNET NETWORK TOPOLOGY

The configuration of the plant's Ethernet network might be dictated by the plant IT department. One common configuration is the star type topology, where a master device will connect to a switch, and all devices

participating on the network (Vision 20/20 panels) will also be connected to the switch. All Vision 20/20 panels would have unique static IP addresses and the master would communicate to each.

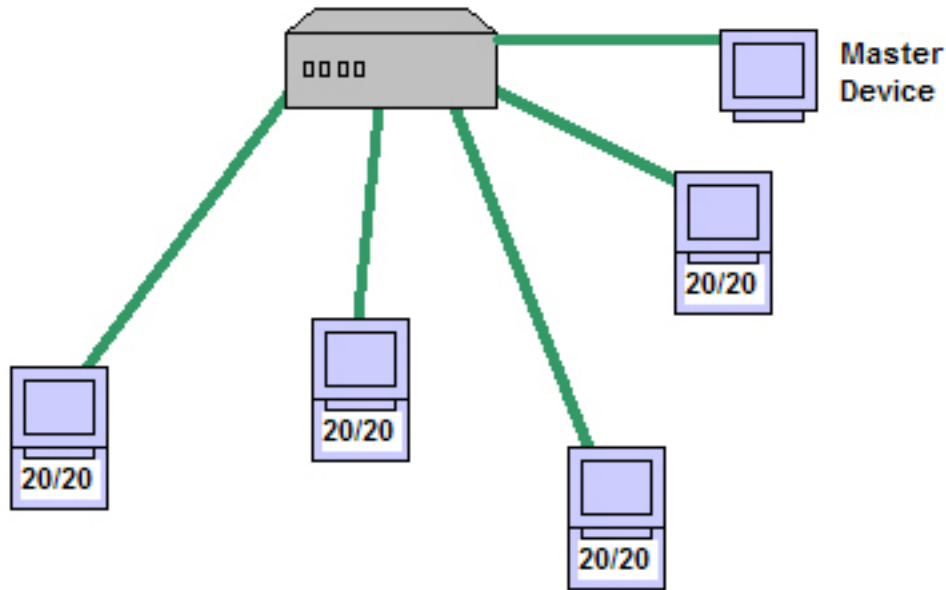

Figure C-8. Ethernet Network Topology

## Appendix C • Remote Control and Monitoring of Vission 20/20 Panel

### ADDITIONAL NETWORK CONFIGURATIONS FOR ACCESS VIA INTERNET

There are many network configurations that will allow access to the Vilter™ Vission 20/20™ panels via an internet connection. Cost and network support is a consideration when the plant IT department has restrictions about outside access. It is recommended to work with them to setup an acceptable network. The configurations below are examples only. Setup and support of these networks are beyond the ability of Vilter™.

### Example 1

In Figure C-9, this example shows a PC connected to the internet, running a program which accesses a PC within a plant. Both computers would have a Remote Desktop program running on them that allows the off-site PC to connect to the plant PC, gain control of it, and then run a VNC program that resides on the plant's PC to gain access to the Vission 20/20 panels.

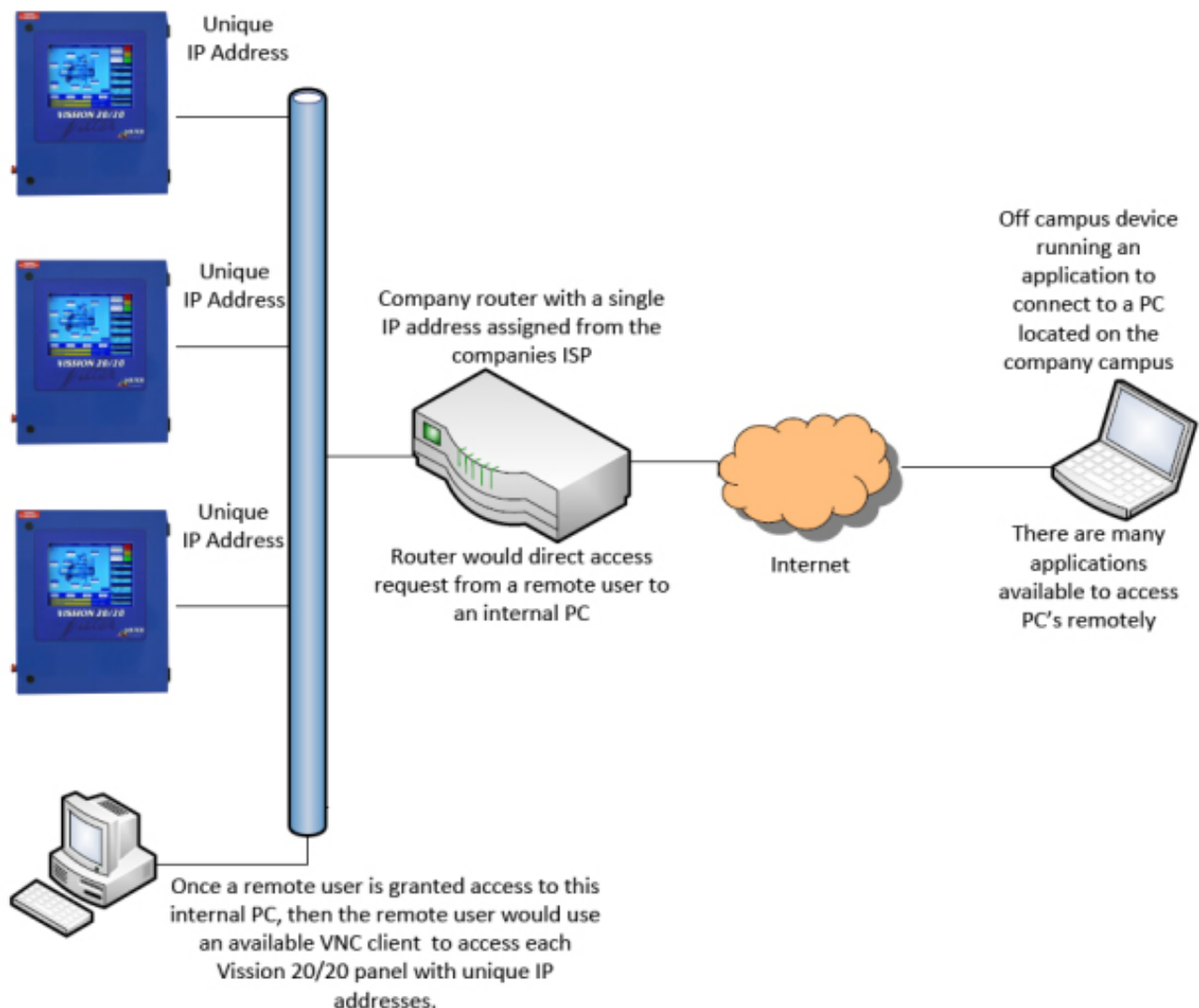

Figure C-9. Network Configuration for Access via Internet – Example 1

## Appendix C • Remote Control and Monitoring of Vission 20/20 Panel

### Example 2

In Figure C-10, this example shows a PC connected to the internet, running a VNC client program which accesses

the Vission 20/20 panels by specifying an IP address assigned to a company router. There would be a separate IP address for each 20/20 panel in the plant.

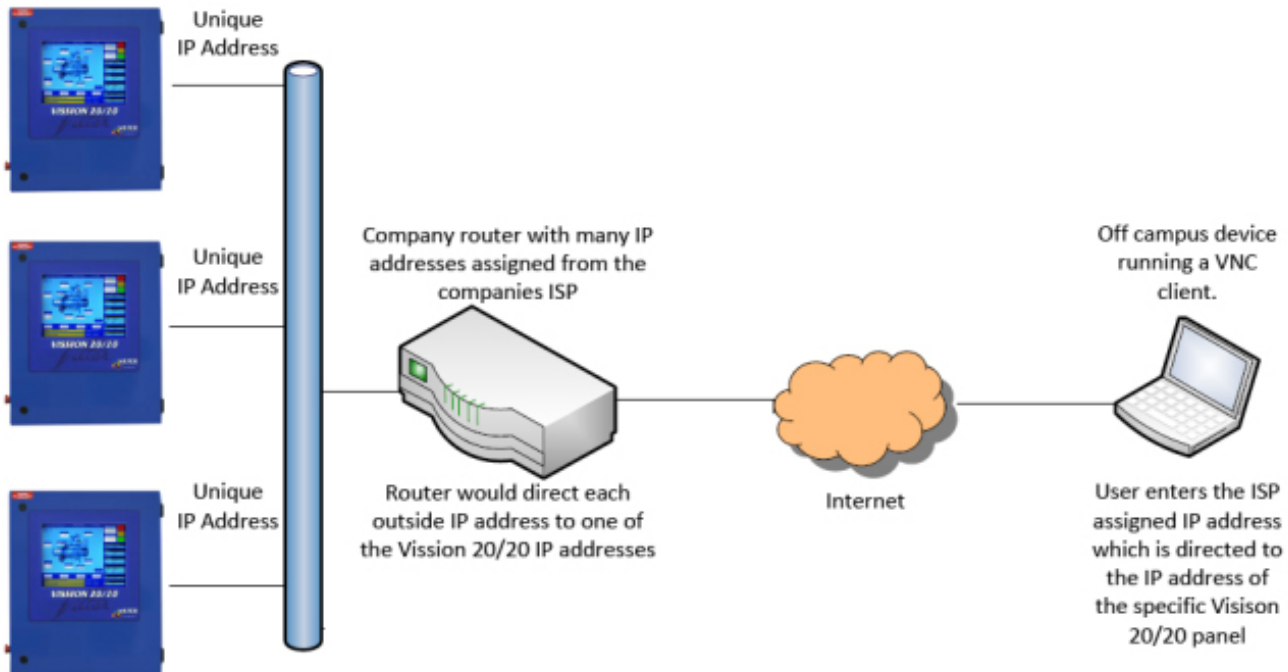

Figure C-10. Network Configuration for Access via Internet – Example 2

### Example 3

In Figure C-11, this example shows a PC connected to the internet, running a VNC client program which

accesses the Vission 20/20 panels by specifying an IP address along with a router port designation. Each Vission 20/20 panel has an assigned router port.

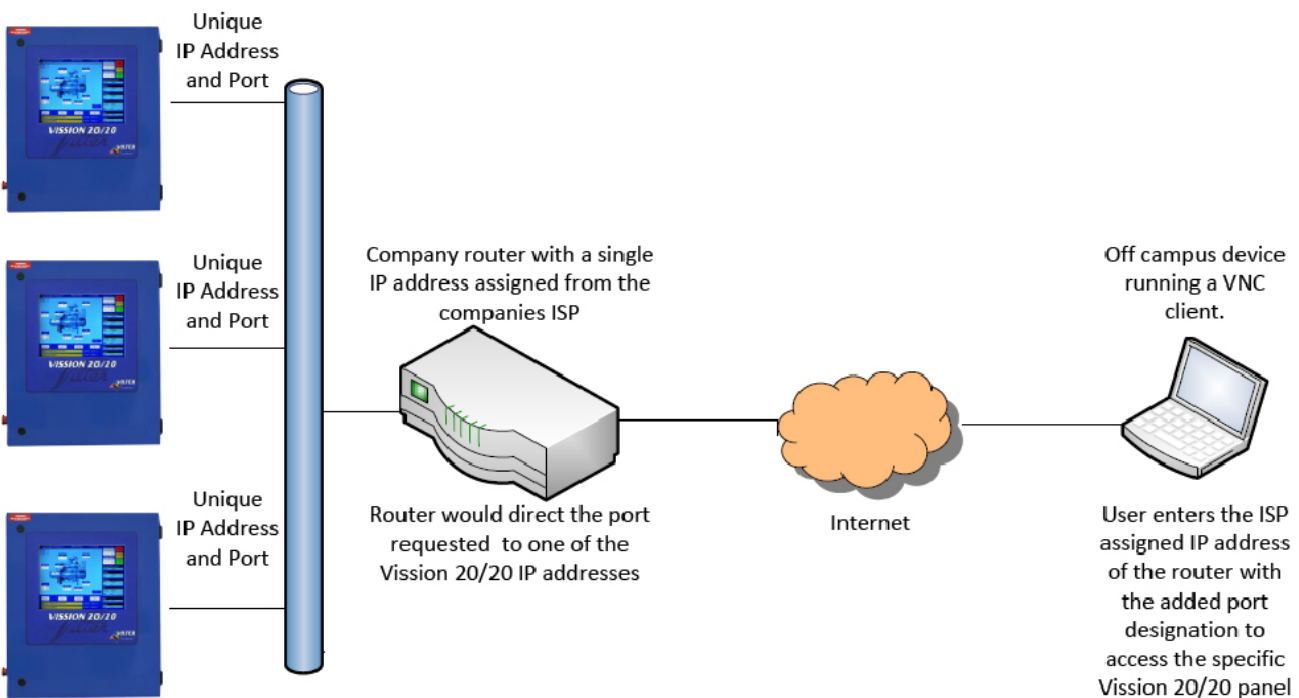

Figure C-11. Network Configuration for Access via Internet – Example 3

## Appendix C • Remote Control and Monitoring of Vission 20/20 Panel

### Example 4

In Figure C-12, this example shows a hybrid network. An off campus PC and smartphone are connected to the internet, running VNC client programs which access the Vission 20/20 panels by specifying an IP address along with a router port designation. Each Vission 20/20 panel has an assigned router port. The company router is a wireless router which also forms a wired LAN network.

the VNC client application will ask for password for 20/20 panel access. Password = VVNC.

### EXAMPLE SETUP USING A WIRELESS ROUTER

An example of an Ethernet radio transmitter is a Phoenix Contact RAD 80211 XDB.

### VNC CLIENTS

Smartphone runs VNC client application – connecting to internet.

Home computer runs VNC client application – connecting to the internet.

The VNC client connects to the “remote site” router which has an outside accessible IP address. The Vission 20/20 boxes have built-in VNC servers. The Ethernet ports on the Vission 20/20 panels would be setup for Modbus TCP protocol. When the connection is made,

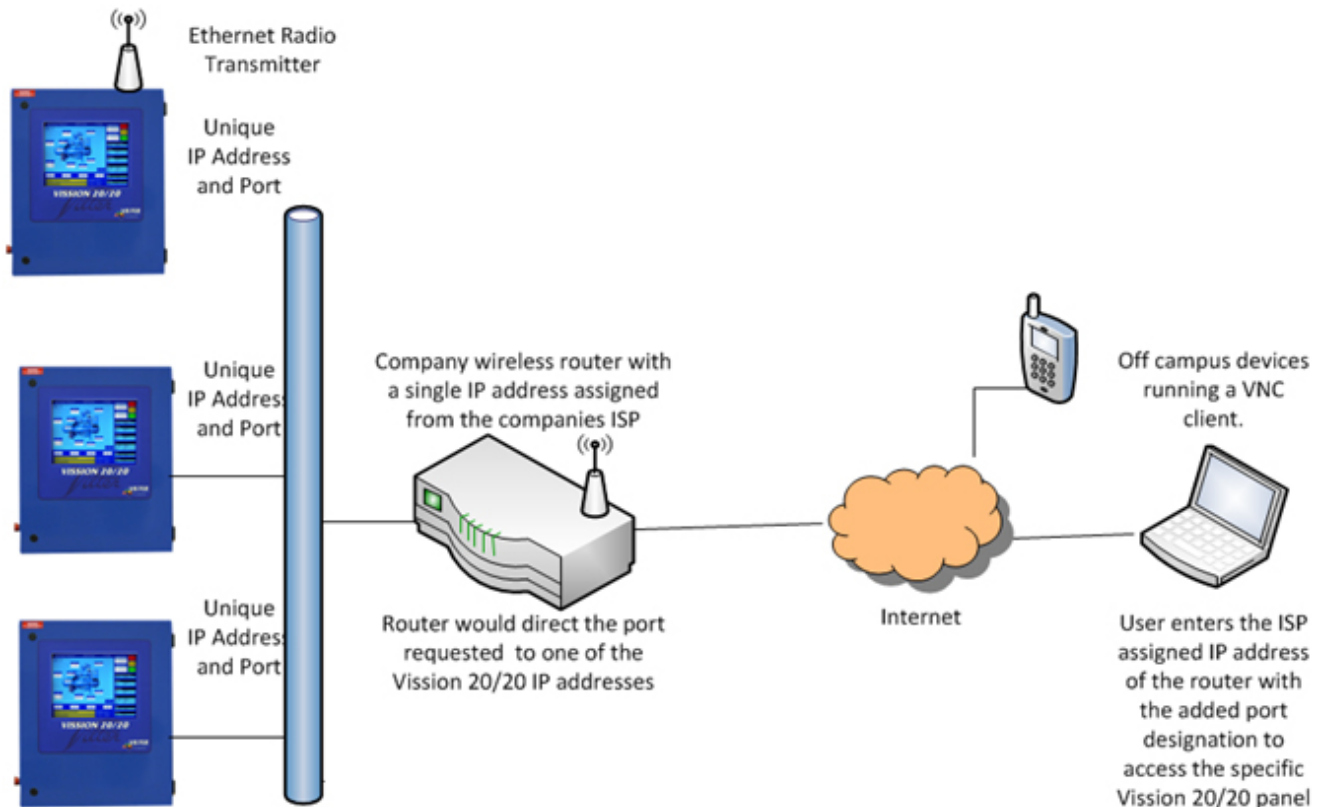

Figure C-12. Network Configuration for Access via Internet – Example 4

# Appendix C • Remote Control and Monitoring of Vission 20/20 Panel

## Accessing VNC from Web Browser

Any web browser can be used to connect to a Vission 20/20 in the network.

Please read the steps below to access the Vission 20/20 Panel Desktop using Firefox web browser.

1. Download Java on your desktop / laptop as a Java Enabled Web Browser is needed.



2. After Installing Java, change the security Level to Medium from the Java Control panel, otherwise VNCViewer will get blocked while trying to access VNC server.

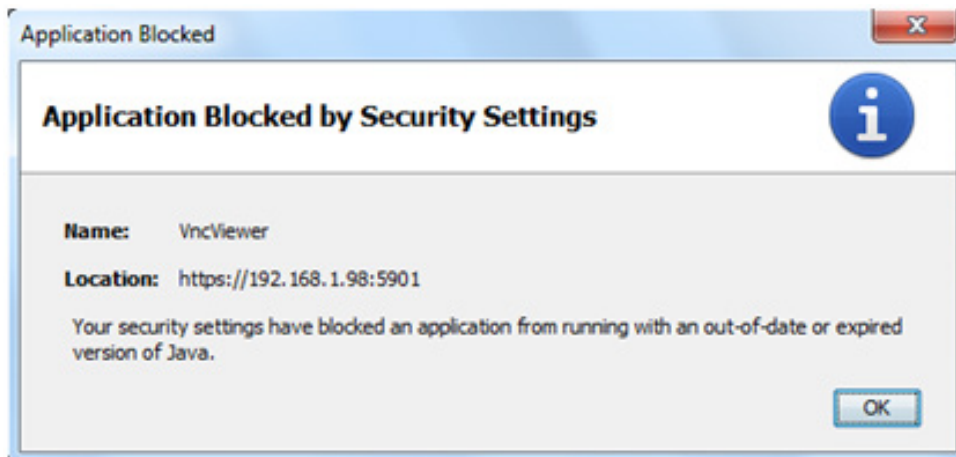



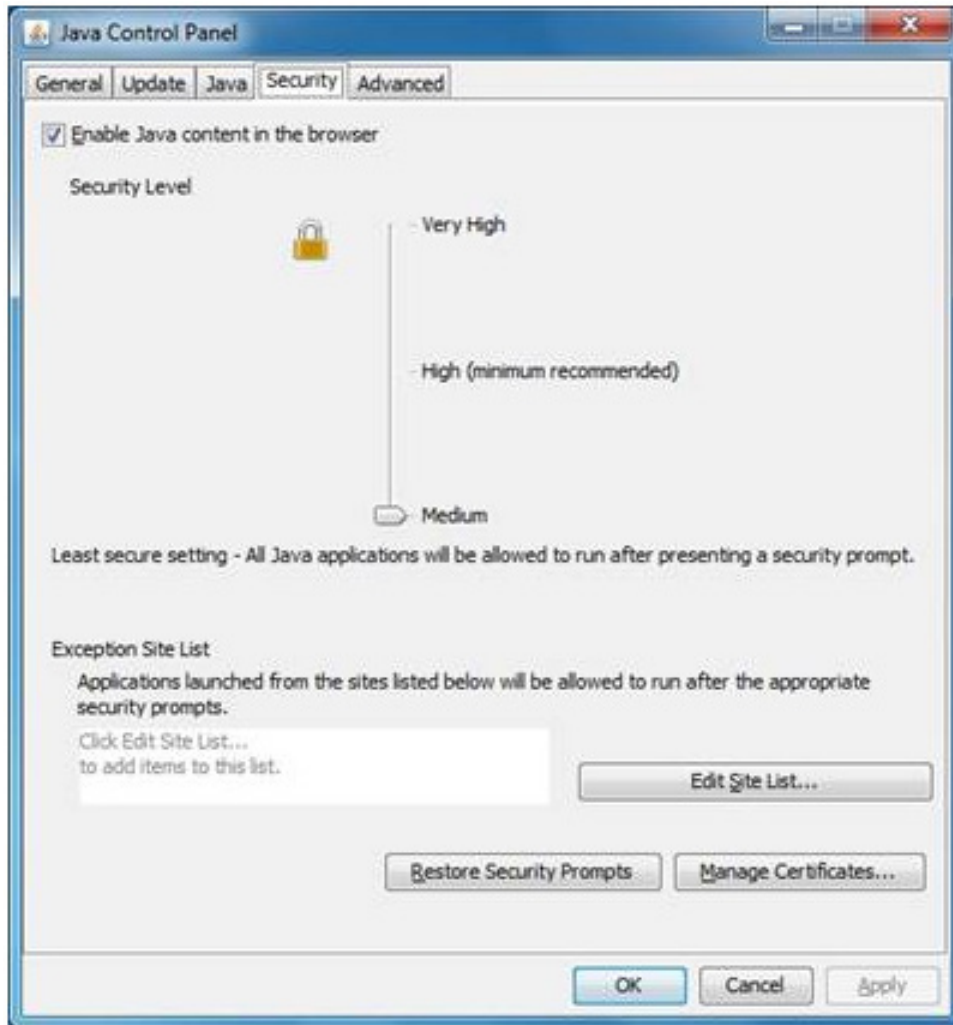

3. Open Browser and type Panel's IP Address and Port Number.
  - Example: If Panel IP Address is 192.168.1.98 and Browser Port Number is 5901 then type `https://192.168.1.98:5901/` address in web browser.
  - On accessing the above address there will be a security warning prompt. Click on "I Understand the Risks".

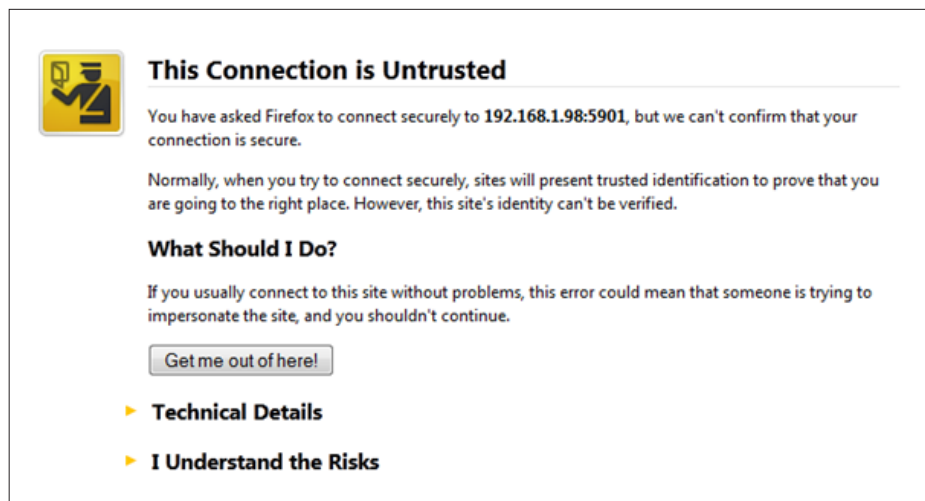



# Appendix C • Remote Control and Monitoring of Vission 20/20 Panel

4. Click on “Add Exception”.

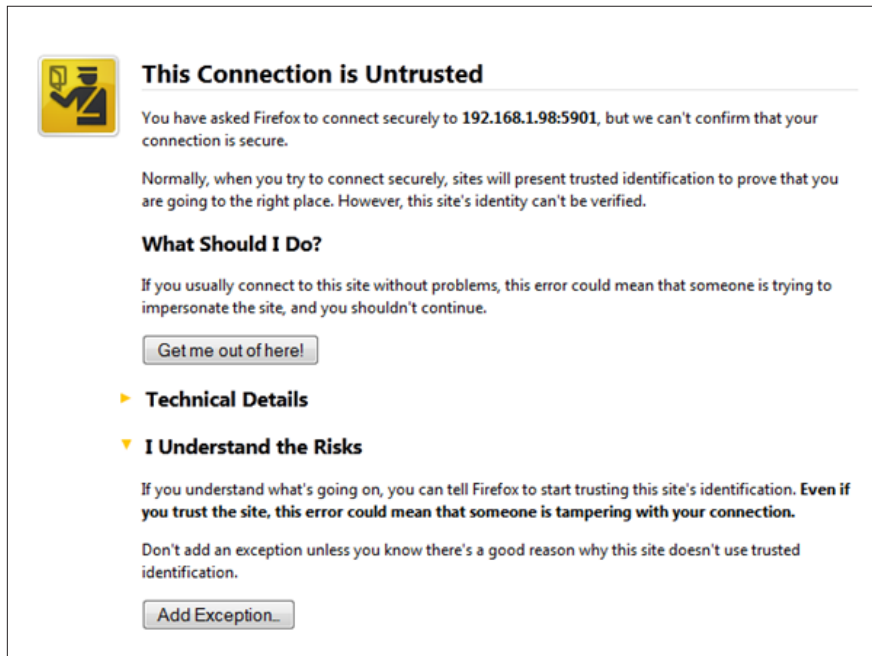

5. Click on “Confirm Security Exception”.

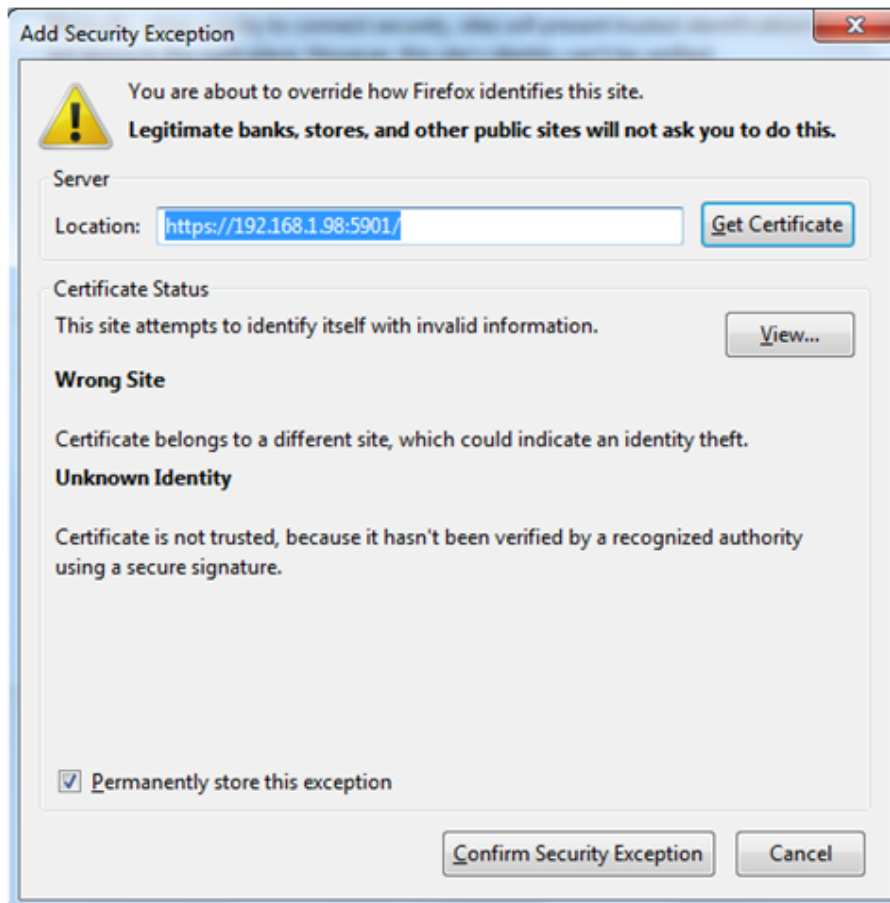

## Appendix C • Remote Control and Monitoring of Vission 20/20 Panel

- Click on “Confirm Security Exception”.

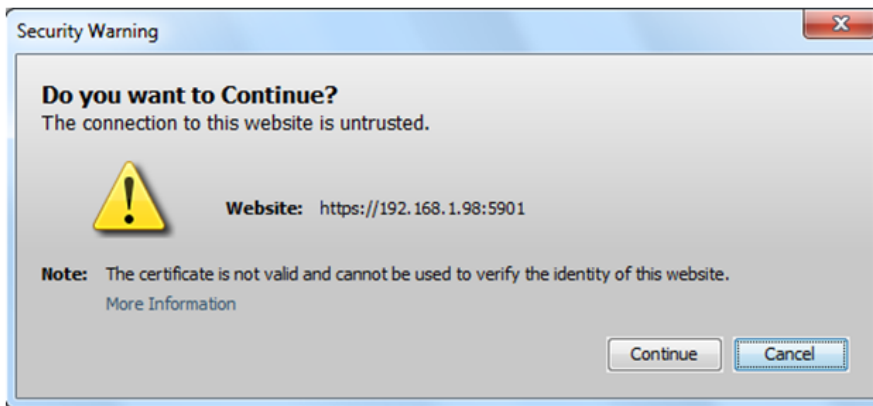

- Check “I accept the risk and want to run this app” and click on “Run” button.

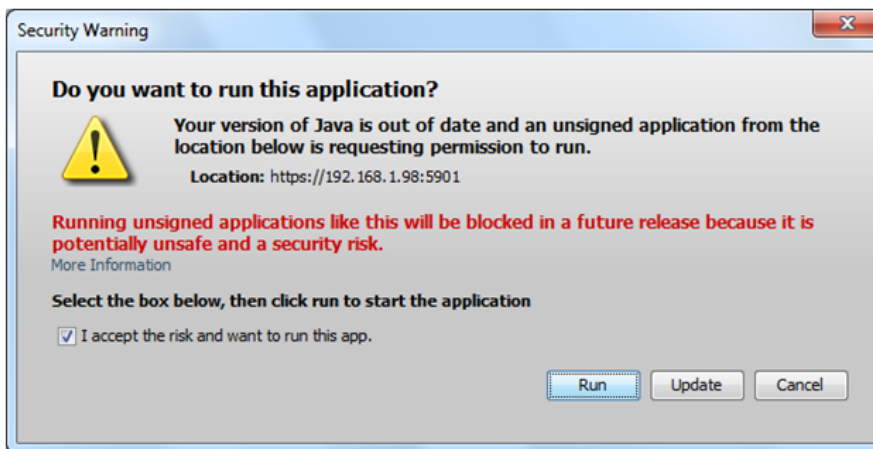

- Click on “Yes” button.

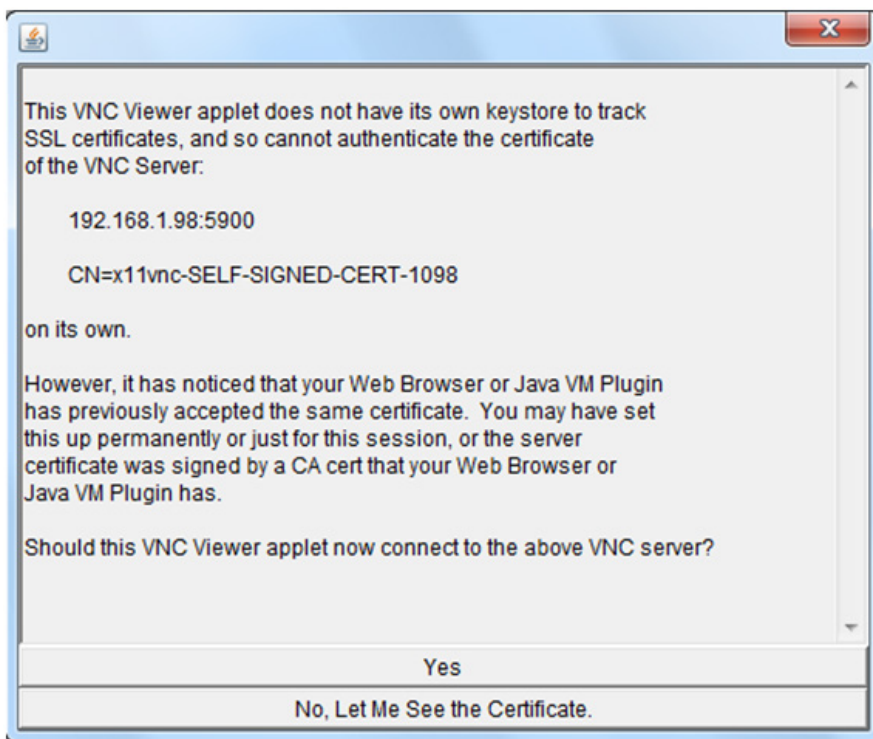

# Appendix C • Remote Control and Monitoring of Vission 20/20 Panel

9. There will be a Dialog Prompt for Password Authentication.

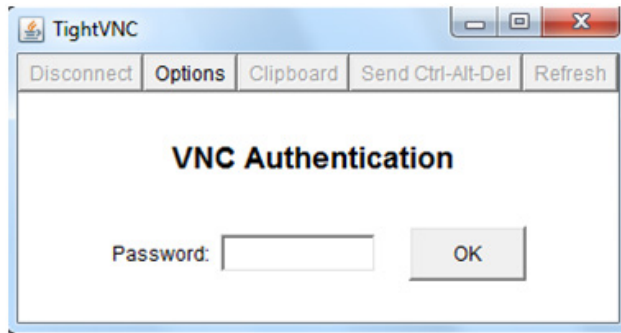

10. Type the VNC Password and you're logged in.

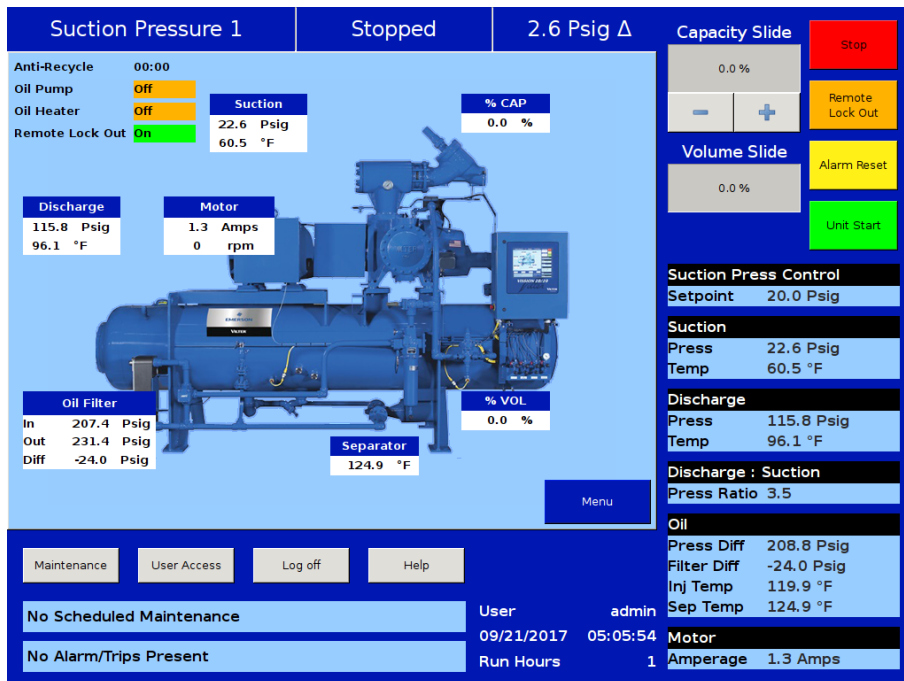

## Accessing VNC from Desktop Client When Web Browser Option is Enabled

To have VNC access from a desktop when the web browser option is enabled you require SSVNC Client. Please see below for the steps.

1. Download and open SSVNC Viewer Application.

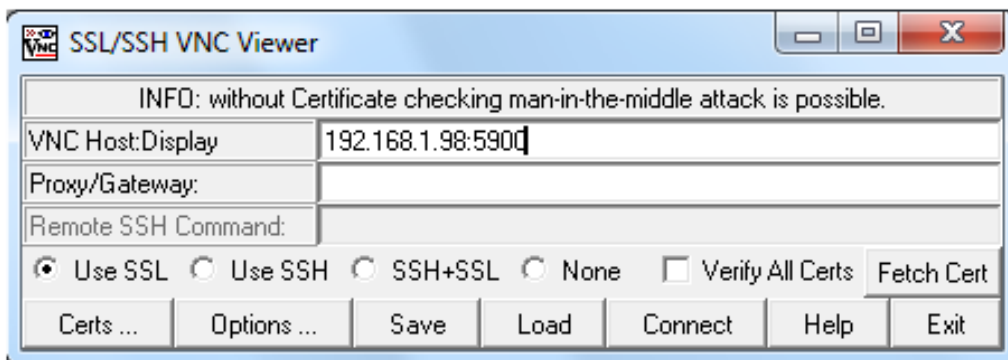

## Appendix C • Remote Control and Monitoring of Vission 20/20 Panel

- Enter the IP address and VNC Port Number as displayed in the image, Uncheck the “Verify All Certs” checkbox and click on “Connect” button.

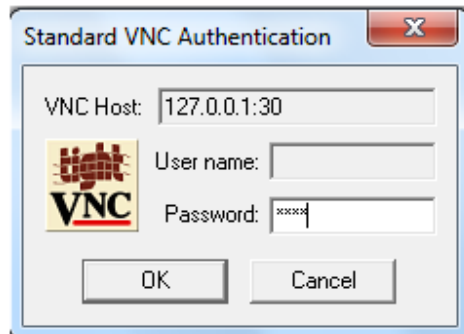

- Type the VNC Password and you're logged in.

The screenshot displays the Vission 20/20 panel remote control interface. The main area shows a 3D model of the compressor with various data points overlaid:
 

- Suction Pressure 1:** 22.6 Psig, 60.5 °F
- Discharge:** 115.8 Psig, 96.1 °F
- Motor:** 1.3 Amps, 0 rpm
- Oil Filter:** In 207.4 Psig, Out 231.4 Psig, Diff -24.0 Psig
- Separator:** 124.9 °F
- Capacity Slide:** 0.0 %
- Volume Slide:** 0.0 %
- Suction Press Control:** Setpoint 20.0 Psig
- Suction:** Press 22.6 Psig, Temp 60.5 °F
- Discharge:** Press 115.8 Psig, Temp 96.1 °F
- Discharge : Suction:** Press Ratio 3.5
- Oil:** Press Diff 208.8 Psig, Filter Diff -24.0 Psig, Inj Temp 119.9 °F, Sep Temp 124.9 °F
- Motor:** Amperage 1.3 Amps

 The interface also includes a 'Menu' button, 'Maintenance', 'User Access', 'Log off', and 'Help' buttons at the bottom. Status indicators show 'No Scheduled Maintenance' and 'No Alarm/Trips Present'. User information includes 'User: admin', '09/21/2017 05:05:54', and 'Run Hours: 1'.

### Notes:

- The default password is VVNC and the default Port Number is 5900.
- The SSVNC client is required only if the web browser option is enabled.
- If the web browser option is not enabled then any normal VNC client without SSL/SSH support can be used; SSVNC client will not work.

### PLC REMOTE COMPRESSOR CONTROL OF VISSION 20/20

PLC remote compressor control of the Vission 20/20 panel (either via communications or hardwired) is accomplished by placing the panel into Remote mode.

Remote Control Mode in the panel refers to two distinct ways of controlling the compressor.

- Control via communication port. This can be accomplished through:
  - Ethernet ( via Ethernet I/P or Modbus TCP/IP )
  - Serial (RS485 Modbus RTU )
- Control via Direct I/O (Digital inputs)

## Appendix C • Remote Control and Monitoring of Vission 20/20 Panel

### REMOTE COMPRESSOR CONTROL VIA COMMUNICATIONS

A compressor control scheme that is accomplished via communications must follow some general rules. The Vission 20/20 panel does not have a separate processor to handle communications from a computer or PLC. All tasks that the panel needs to accomplish are done by a single processor. So when a device communicates to the

panel, the polling rate to the 20/20 panel can't be unlimited, it needs to be governed.

A typical compressor control scheme might look like this:

(For communication register information, refer Table D-1)

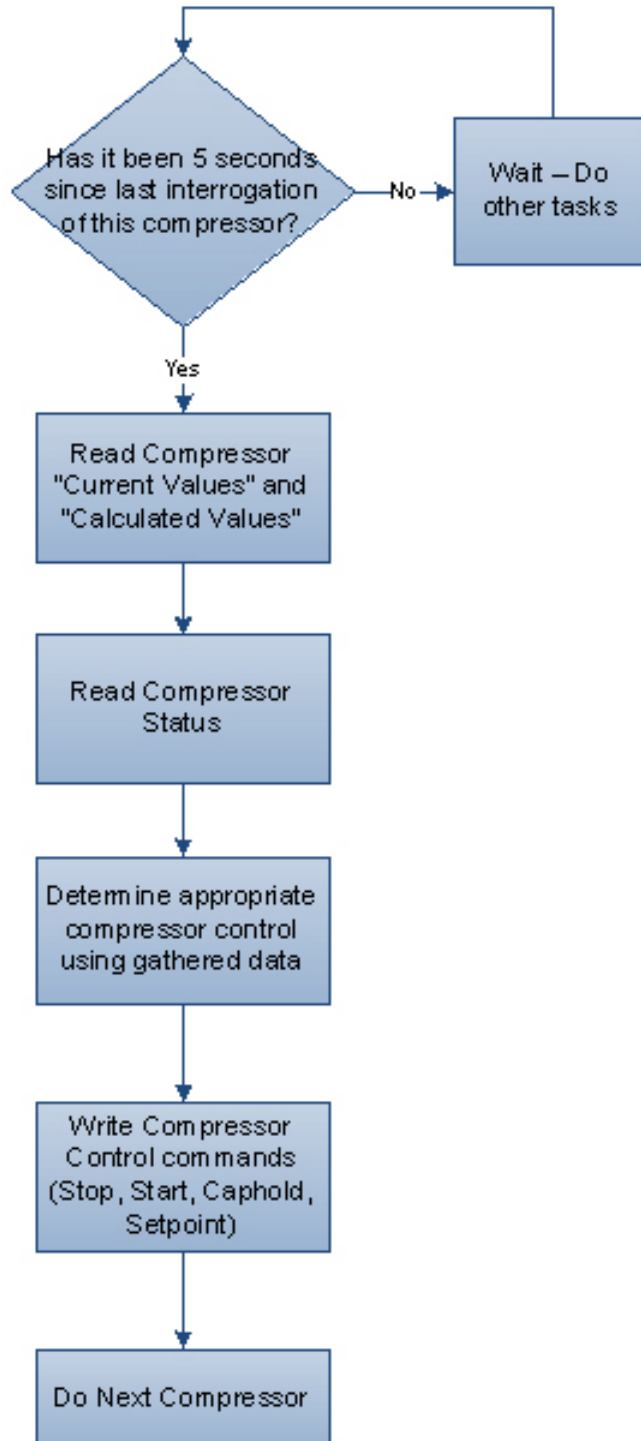

Figure C-13. Typical Block Diagram of a Multi-Compressor Control Scheme (1 of 4)

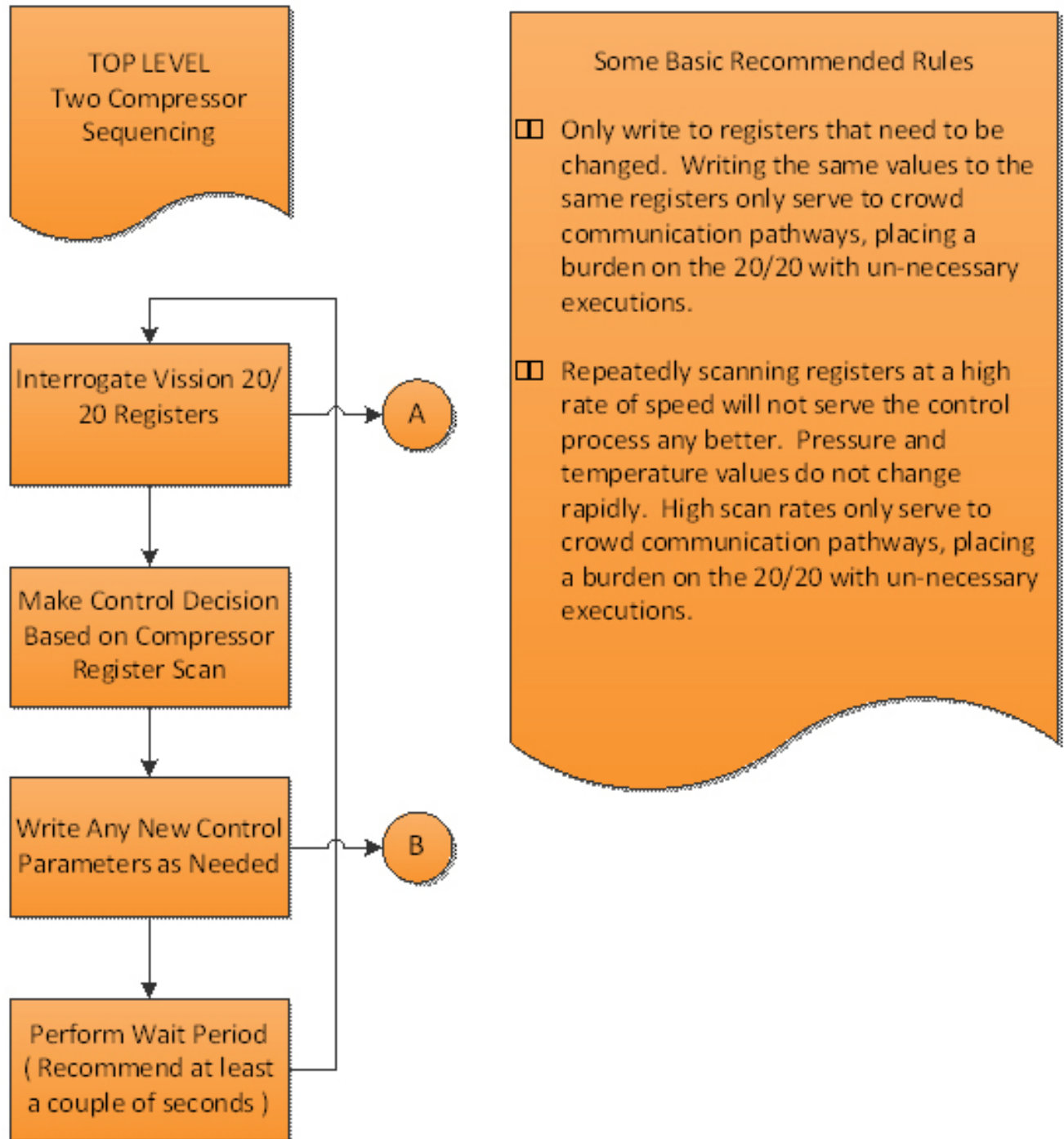

Figure C-13. Typical Block Diagram of a Multi-Compressor Control Scheme (2 of 4)



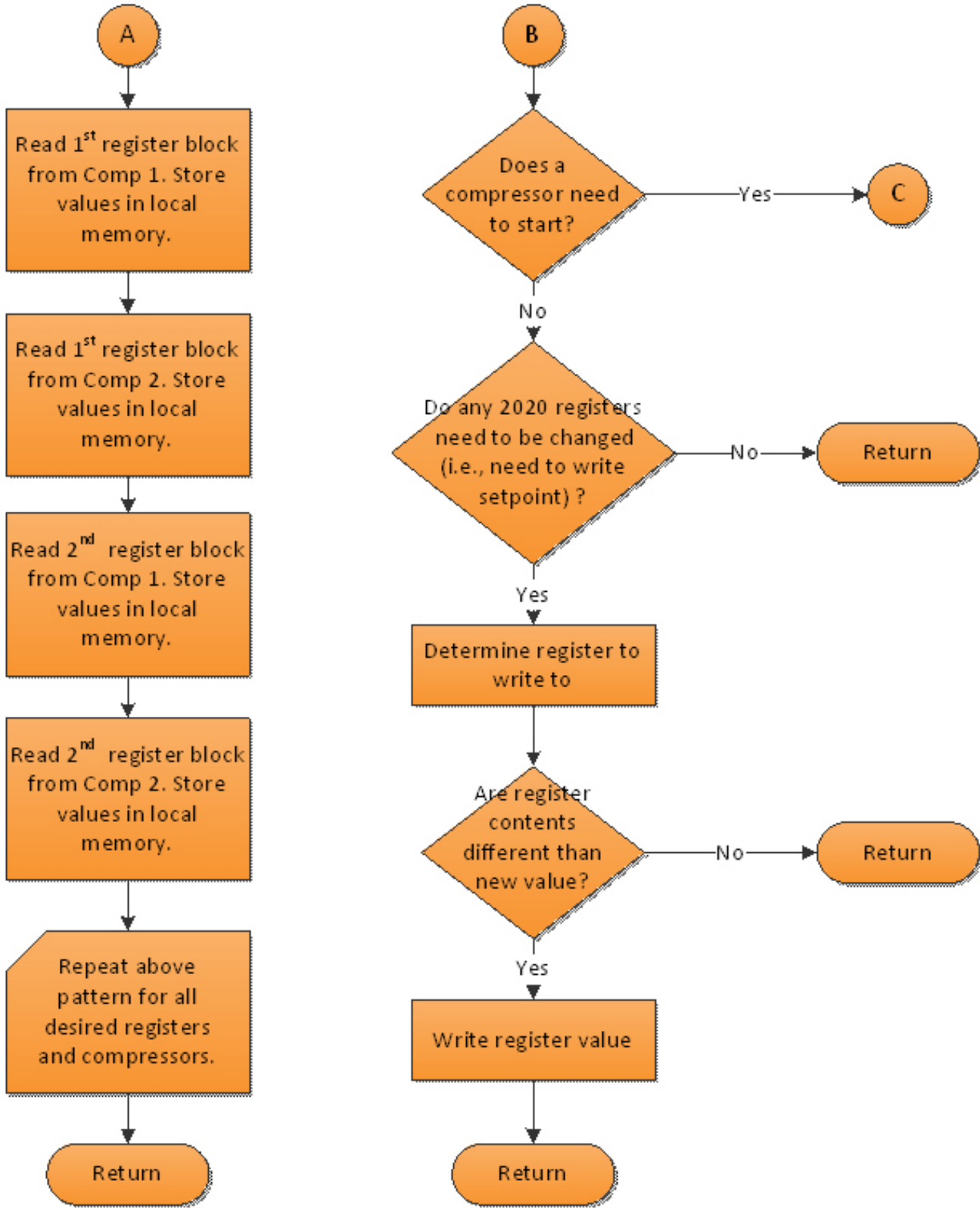
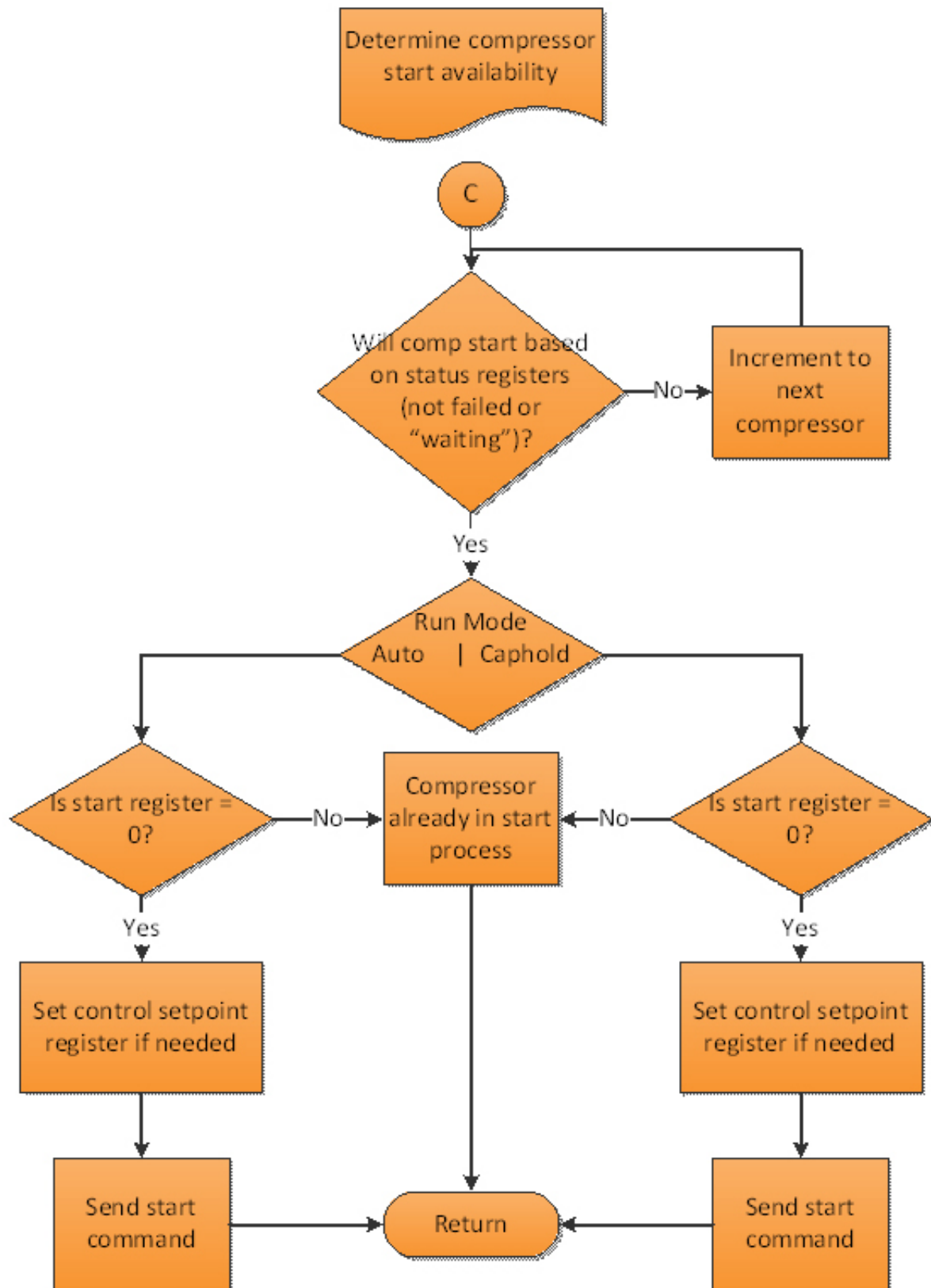

Figure C-13. Typical Block Diagram of a Multi-Compressor Control Scheme (3 of 4)



**Figure C-13. Typical Block Diagram of a Multi-Compressor Control Scheme (4 of 4)**  
*The actual control scheme that you use will depend upon the response of the process that you are trying to control.*



# Appendix C • Remote Control and Monitoring of Vission 20/20 Panel

## CONFIGURATION SCREEN SETUP FOR REMOTE CONTROL THROUGH COMMUNICATIONS

(Reference the “Communication” section of Figure C-14)

For Ethernet control:

1. Configure “Active Remote Control” as Ethernet.
2. At the bottom of the column, check the “Ethernet” box.
3. Configure Ethernet I/P address.
4. Select Modbus TCP or Ethernet I/P protocol

For Serial Port Modbus RTU control:

1. Configure “Active Remote Control” as Serial
2. Check the “Serial” box inside the “Communications” section.
3. Configure serial port settings (baud rate, # data bits, # stop bits, parity) and panel ID number (which is “node” number for Modbus RTU.)

Once the port is setup properly, communication can be established. You will be able to read from and write (see note) to registers.

### NOTE

In order to “write” to a register in the Control Block region of Modbus registers 40500 through 40513, the Vission 20/20 panel must be placed into “Remote” mode, by pressing the green “Unit Start” button, and then pressing “Remote”. The panel will be placed into “Remote” mode, which will allow register “writes” in this region to occur. You can write to setpoints outside this region without placing the panel into “Remote” mode.

## INTRODUCING THE REMOTE LOCK BUTTON AND RESTART ON POWER FAILURE SELECTION

Remote Lock

- The Remote Lock Button sets the Remote Lock condition (ON or OFF). This determines when communication “writes” for Compressor Command registers

Figure C-14. Configuration screen - Page 1

## Appendix C • Remote Control and Monitoring of Vission 20/20 Panel

---

within the Modbus range of 40500 through 40513 can occur. If Remote Lock is ON, then writes within this region cannot occur. These registers are the compressor control registers (Start, Stop, Caphold etc). Remote Lock is typically used to lock out a PLC or central computer while the operator is operating the compressor locally. The Remote Lock button is located directly below the Compressor STOP button. The status of Remote Lock is shown in the upper left corner of the Main Screen.

### RESTART ON POWER FAILURE

- The Vission 20/20 allows for selection of different operations to occur after a power failure has occurred. The selections determine in which mode of operation the 20/20 will be placed after the power is restored to the panel. This should be decided upon and setup prior to communicating to the 20/20 panel.
  1. Always
  2. Never
  3. Timed
  4. Remote Lock Off
  5. Boot in Remote (Direct I/O)
- 1. Always
  - If the compressor was off prior to the power failure, it will stay off after the power is restored.
  - If the compressor was running prior to the power failure, it will begin an Auto-restart sequence as soon as power is restored.
  - In both cases, the Remote Lock will be ON after power is restored, which means it will not accept any “writes” via communication within the Compressor Command register region, until someone walks up to the panel and presses Unit Start-> Remote.
- 2. Never
  - The compressor will not restart after power is restored. The Remote Lock will be ON after power is restored, which means it will not accept any “writes” via communication within the Compressor Command register region, until someone walks up to the panel and presses Unit Start-> Remote.
- 3. Timed
  - The compressor WILL attempt a restart after power is restored and the Max Restart After Power Failure timer has timed out. The Remote Lock will be ON after power is restored, which means it will not accept any “writes” via communication within the Compressor Command register region, until someone walks up to

the panel and presses Unit Start-> Remote.

4. Remote Lock Off
  - The Vission 20/20 panel will boot up with the Remote Lock OFF which will allow the panel to accept all remote control commands, via communication, immediately after power is restored to the panel.
5. Boot in Remote (Direct I/O)
  - The Vission 20/20 panel will boot up with the Remote Lock OFF and be placed into REMOTE mode, which will allow the panel to accept Direct I/O commands immediately after power is restored to the panel.

### COMMON REGISTER SETUP TO CONTROL THE VISSION 20/20 (COMPRESSOR CONTROL) VIA COMMUNICATIONS

#### Register Setup and Control Scenario

- The Vission 20/20 panel first needs to be placed in REMOTE mode before the Compressor Control commands (Registers 40500 through 40513) can be sent. To do this, press the green UNIT START button, then REMOTE.

### Modbus Register 40501 - Active Remote Control

Reading this register can be used to verify the Active Remote Control mode, which was previously setup from the Configuration screen. Writing to this register can change the Active Remote Control mode, however this is not common.

- 0 = None (internal local setpoints will be used to control the compressor).
- 1 = Direct I/O (hardwired control - via digital inputs. Refer to wiring diagram.)
- 2 = Serial (serial communications via RS485 Modbus RTU).
- 3 = Ethernet (Modbus TCP or Ethernet IP communications.)

## Appendix C • Remote Control and Monitoring of Vission 20/20 Panel

Typically, the following registers are setup (written to) before a “Start” command is issued to the compressor:

### Modbus Register 40502 - Remote Capacity Control Selection

- 0 = Auto Capacity Control. This selection defines that the 20/20 will control compressor capacity from its internal Control Setpoints.
- 1 = Pulse Load/Unload. This selection defines that the 20/20 will control compressor capacity from contents of Pulse Load register 40504 and Pulse Unload register 40505.
  - For correlation between register content and pulse value, see Table D-1.
- 2 = Hold Capacity %. This selection defines that the 20/20 will control compressor capacity from contents of Capacity Hold % register 40506.

If Hold Capacity % is selected, then it is typical to write a Capacity Hold value to register 40506 before the compressor is started, typically 5%, to prevent the compressor from loading immediately.

### Modbus Register 40506 - Capacity Hold %

Value = 0-100

#### Hold Capacity Operation

- Capacity Hold commands define a “target” capacity slide valve position for the compressor. The 20/20 will position the capacity slide to the “target” position. rules of this capacity hold algorithm are:
  1. If the new target is < 0.4% (full scale) away from the current position – then don’t do anything – this is the deadband region.
  2. If new target is > deadband region but < 10% (full scale) away from the current position, then energize the capacity slide for a time that is proportional to the amount it is away from the new target position. To say it another way – the further you are away from the new target position – the longer the slide is energized in the proper direction. This control region is called the proportional band region.
  3. If new target is > 10% (full scale) away from current position (greater than the proportional band region) – then energize continuously.

There are mechanical properties that limit the speed at which the capacity of the compressor can be changed. The capacity slide actuators can only turn so fast. The proportional change to the compressor capacity occurs at a fixed rate.

#### Caphold and Operation with VFD

- Using a VFD with a compressor requires considering the VFD capacity as part of the entire capacity of the compressor. Typically, a VFD is operated from 50% to 100% speed, therefore the VFD is considered ½ the total capacity and the slide valve movement is considered the other ½ of total capacity. When a VFD is employed, the normal control method is to first move the capacity slide from 0-100% when additional refrigeration is required. When the capacity slide is at 100% and additional capacity is still required, then the VFD is ramped up in speed. It follows then that a Caphold value of 25% will move the capacity slide to 50% position. A Caphold value of 50% will move the capacity slide to 100% position. A Caphold value of 75% will move the capacity slide to 100% and the VFD to 50% speed... and so on.

Consideration should also be given so that when moving the capacity slide valve from 0-100%, the actual corresponding capacity of the compressor is not changing in a linear relationship of 0-100%. The last 15% travel of the slide valve results in a greater change of capacity than 15%. Integrators should realize that the caphold value sent relates to slide valve “position” and not actual capacity of the compressor. For most purposes however, assuming a linear relationship is adequate.

The rate at which the capacity slide moves from 0-100%, and the rate at which the VFD increases speed from minimum to maximum is not the same. So there are two different capacity profiles that the integrator needs to consider.

### Modbus Register 40507 - Active Setpoint.

This register is used in conjunction with Register 40502 = 0, Auto Capacity Control mode.

1 = Setpoint #1 Active

2 = Setpoint #2 Active (note: you must enable two setpoints from configuration screen first).

Sometimes compressors are switched from Suction Pressure control mode to Process Temp control mode or vice versa. This can be done via communications using the following register.

### NOTE

Both Process Temp Control and Suction Pressure Control must be enabled from the Configuration screen to do this.

### Modbus Register 40503 - Auto Capacity Control Type

- 0 = Suction Pressure (if enabled from Configuration screen)
- 1 = Process Temp (if enabled from Configuration screen)
- 2 = Discharge Pressure (if enabled from Configuration screen)

### Compressor Start and Stop Commands

#### Modbus Register 40508 - Start Command

- 1 = Start Compressor in Remote Auto Mode
- 2 = Start Compressor in Auto Sequencing Mode

Four (4) minute Remote mode time-out timer

- Once the compressor has been started in Remote Auto Mode using the Start Compressor Command, a 4 minute timer will start. If no further communication takes place to the 20/20 within 4 minutes, the 20/20 will be placed in Local Auto mode, a yellow banner will be displayed on the 20/20 signifying that a “Remote Comm Time-out” occurred, and the Event List will get populated with a time-stamped “Remote Comm Time-out” event.

#### Modbus Register 40509 - Stop Command

- 1 = Stop Compressor Command
- Vission 20/20 panel will remain in Remote (Idle) mode after a Stop Compressor command has been issued.

### Remote Control via Direct I/O (Hard-wired)

Remote Control of the compressor can also be accomplished using hard-wired inputs. These include Remote Start-Stop digital input, Remote Increase Capacity digital input, Remote Decrease Capacity digital input, and Remote Caphold Setpoint analog input. For communication register information, refer to Table D-1.

Configuration Screen Setup:

(Reference the “Communication” section of Figure C-14)

For Direct I/O control:

- Configure the “Active Remote Control” drop-down box to “Direct I/O”. This selection activates the Remote Start-Stop digital input. This is the ONLY selection that activates the Remote Start-Stop digital input.
- Below the “Active Remote Control” selection box, check the “Direct I/O” box.

A popup “Direct I/O Control Type” box now appears, from which you can select the desired control method:

- Auto Capacity
- (Digital) Manual Capacity – comp. capacity controlled via digital increase and decrease inputs.
- (4-20mA) Capacity Hold – compressor capacity controlled via Remote Caphold analog input.

Auto Capacity

- The compressor is started and stopped from the Remote Start/Stop input, but the compressor capacity is controlled from the internal compressor control setpoints entered in the 20/20. The Auto-cycle setpoints can be enabled or disabled as desired.

(Digital) Manual Capacity

- The compressor started and stopped from the Remote Start/Stop input, but the compressor capacity is controlled from the Remote Capacity Increase and Remote Capacity Decrease digital inputs.

(4-20mA) Capacity Hold

- The compressor started and stopped from the Remote Start/Stop input, but the compressor capacity is controlled from a 4-20mA analog signal run to 20/20. The 4-20ma signal will be proportional to 0-100% capacity hold value. For instance, 4mA = 0 percent, 12mA = 50%, and 20mA = 100%.

Hold Capacity Operation

- The Capacity Hold analog signal defines a “target” capacity slide valve position for the compressor. The 20/20 will position the capacity slide to the “target” position. rules of this capacity hold algorithm are:
  1. If the new target is < 0.4% (full scale) away from the current position – then don’t do anything – this is the

## Appendix C • Remote Control and Monitoring of Vission 20/20 Panel

deadband region.

2. If the new target is > deadband region but < 10% (full scale) away from the current position, then energize the capacity slide for a time that is proportional to the amount it is away from the new target position. To say it another way – the further you are away from the new target position – the longer the slide is energized in the proper direction. This control region is called the proportional band region.
3. If the new target is > 10% (full scale) away from current position (greater than the proportional band region) – then energize continuously.

There are mechanical properties that limit the speed at which the capacity of the compressor can be changed. The capacity slide actuators can only turn so fast. The proportional change to the compressor capacity occurs at a fixed rate.

### Caphold and Operation with VFD

- Using a VFD with a compressor requires considering the VFD capacity as part of the entire capacity of the compressor. Typically, a VFD is operated from 50% to 100% speed, therefore the VFD is considered  $\frac{1}{2}$  the total capacity and the slide valve movement is considered the other  $\frac{1}{2}$  of total capacity. When a VFD is employed, the normal control method is to first move the capacity slide from 0-100% when additional refrigeration is required. When the capacity slide is at 100% and additional capacity is still required, then the VFD is ramped up in speed. It follows then that the 4-20ma Caphold signal is broken down into two parts:
  - 4-12 mA = 0 -100 slide valve position
  - 12-20ma = VFD minimum speed to VFD maximum speed.

Consideration should also be given so that when moving the capacity slide valve from 0-100%, the actual corresponding capacity of the compressor is not changing in a linear relationship of 0-100%. The last 15% travel of the slide valve results in a greater change of capacity than 15%. Integrators should realize that the caphold value sent relates to slide valve “position” and not actual capacity of the compressor. For most purposes however, assuming a linear relationship is adequate.

The rate at which the capacity slide moves from 0-100%, and the rate at which the VFD increases speed from minimum to maximum is not the same. So there are two different capacity profiles that the integrator needs to

consider.

### Remote Enable Output

- When the compressor is off and in Remote mode, an enable output will provide a signal to indicate that the 20/20 is in a condition where it is ready to be started. No start inhibit conditions exists, the 20/20 is not in anti-recycle mode, and there are no trips active. If the compressor is able to be started, then the Remote Enable output will go on. When the output is on, then closing the Remote Start/Stop input will initiate a compressor start.

#### NOTE

Once the compressor has started, the state of the Remote Enable Output is indeterminate, and has no meaning.

### CONTROL SCENARIO

Once the Configuration Screen has been configured for the desired type of Digital I/O control the Vission 20/20 needs to be placed in REMOTE mode. To do this, press the green UNIT START button, then REMOTE. The Remote Start-Stop input is now active. The state of the Remote Enable Output should be determined by the controlling device. When it is determined to be on, then the controlling device can energize the Remote Start-Stop input. After the compressor has started, then the compressor capacity is controlled by the selected option. Thought should also be given as to how the compressor will be restarted after a power failure occurs.

### REMOTE MONITORING

- It should be noted that while the compressor is being controlled (starting, stopping and capacity control) via hard-wired inputs, the monitoring of compressor operating parameters can still occur by using the communication ports available in the 20/20. Remote monitoring can be accomplished by utilizing either the Ethernet communication port (via Ethernet I/P or Modbus TCP/IP) or the serial port (via RS485 Modbus RTU). For communication register information, refer to Table D-1.

### COMMUNICATION PORT SETUP

*(Reference the “Communication” section of Figure C-14)*

For Serial Port Modbus RTU Monitoring:

- Check the “Serial” box inside the “Communications” section.
- Configure serial port settings (baud rate, # data bits, # stop bits, parity) and panel ID number (which is “node” number for Modbus RTU.)

For Ethernet Monitoring:

- Check the “Ethernet” box inside the “Communications” section.
- Configure IP address and Subnet Mask.
- Select Protocol (Ethernet I/P or Modbus TCP/IP)

Once the port is setup properly, communication can be established. You will be able to read from and write to registers. In Direct I/O mode, you cannot write to registers in the Control Block region of Modbus registers 40500 through 40513.

## Contents

Vision 20/20 Communication Table .....	D-3
Digital Inputs .....	D-3
Digital Outputs .....	D-4
Analog Inputs .....	D-4
Analog Outputs .....	D-5
Calculated Values.....	D-5
Statuses.....	D-6
Commands .....	D-7
Compressor Control Setpoints .....	D-8
Auto Cycle .....	D-9
Pumpdown.....	D-9
Pulldown .....	D-10
Stop Load & Force Unload / Liquid Injection.....	D-10
Slide Valve Control / Oil Control .....	D-11
Compressor VFD.....	D-12
Cool Compression.....	D-13
VI Control .....	D-13
Alarms/Trips (Page 1).....	D-13
Alarms/Trips (Page 2).....	D-14
Alarms/Trips (Page 3).....	D-15
Timers .....	D-15
Compressor Scheduling (Military Time) .....	D-17
Compressor Sequencing .....	D-21
Condenser Control.....	D-22
Remote Oil Cooler.....	D-25
Trend Chart.....	D-27
Configuration (Time) .....	D-29
Configuration (Other).....	D-29
Notes: Analog Outputs / Status Words / Commands / Compressor Scheduling .....	D-31





## Appendix D • Vision 20/20 Communication Table

### Vision 20/20 Communication Table

- All ENUM variables are of INT type
- ALL F-INT data types represent floating point values as INT types multiplied by 10
- All Pressures are in Psig
- All Temperatures are in Fahrenheit
- Modbus TCP addressing is PLC-style (Base 1) addressing
- On Error, Modbus TCP server only returns an error code of “Illegal Data Address”
- All registers returned (INT and F-INT) are 2-bytes long
- For Ethernet/IP, use INT data type and PLC-5 Word Range Read/Write MSG instructions
- Remote commands can’t be issued if the panel is in “Remote Lock” mode
- Polling rates should not be less than 5 sec
- Writes to the Vision should only occur when a value needs to be changed
- Lower Range & Higher Range values mentioned are default values of Vision 20/20
- Users can modify Lower Range & Higher Range values from Vision 20/20 Panel and accordingly maintain their own table

**Table D-1. Vision 20/20 Communication Table**

Vilter™ Address	Ethernet IP Address	Modbus Address	Command Name	Data Type	Value	Mode	Lower Range	Higher Range
			<b>Digital Inputs</b>					
1	N50:0	40001	Compressor Interlock	INT	0 = OFF, 1 = ON	Read		
2	N50:1	40002	High Level Shutdown	INT	0 = OFF, 1 = ON	Read		
3	N50:2	40003	Oil Level Switch #1	INT	0 = OFF, 1 = ON	Read		
4	N50:3	40004	Oil Level Switch #2	INT	0 = OFF, 1 = ON	Read		
5	N50:4	40005	Local / Remote	INT	0 = OFF, 1 = ON	Read		
6	N50:5	40006	Remote Start	INT	0 = OFF, 1 = ON	Read		
7	N50:6	40007	Remote Increase	INT	0 = OFF, 1 = ON	Read		
8	N50:7	40008	Remote Decrease	INT	0 = OFF, 1 = ON	Read		
9	N50:8	40009	Auxiliary 1	INT	0 = OFF, 1 = ON	Read		
10	N50:9	40010	Auxiliary 2	INT	0 = OFF, 1 = ON	Read		
11	N50:10	40011	Auxiliary 3	INT	0 = OFF, 1 = ON	Read		
12	N50:11	40012	Auxiliary 4	INT	0 = OFF, 1 = ON	Read		
13	N50:12	40013	Auxiliary 5	INT	0 = OFF, 1 = ON	Read		
14	N50:13	40014	Auxiliary 6	INT	0 = OFF, 1 = ON	Read		
15	N50:14	40015	Auxiliary 7	INT	0 = OFF, 1 = ON	Read		
16	N50:15	40016	Auxiliary 8	INT	0 = OFF, 1 = ON	Read		
			<b>Digital Outputs</b>					
17	N51:0	40051	Compressor Start	INT	0 = OFF, 1 = ON	Read		
18	N51:1	40052	Oil Pump	INT	0 = OFF, 1 = ON	Read		

## Appendix D • Vission 20/20 Communication Table

Vilter™ Address	Ethernet IP Address	Modbus Address	Command Name	Data Type	Value	Mode	Lower Range	Higher Range
19	N51:2	40053	Capacity Increase	ENUM		Read		
20	N51:3	40054	Capacity Decrease	ENUM		Read		
21	N51:4	40055	Volume Increase	INT	0 = OFF, 1 = ON	Read		
22	N51:5	40056	Volume Decrease	INT	0 = OFF, 1 = ON	Read		
23	N51:6	40057	Oil Separator Heater	INT	0 = OFF, 1 = ON	Read		
24	N51:7	40058	Trip	INT	0 = OFF, 1 = ON (ON when no Trip)	Read		
25	N51:8	40059	Slide Valve Setpoint #1	INT	0 = OFF, 1 = ON	Read		
26	N51:9	40060	Slide Valve Setpoint #2	INT	0 = OFF, 1 = ON	Read		
27	N51:10	40061	Alarm	INT	0 = OFF, 1 = ON (ON when no Alarm)	Read		
28	N51:11	40062	Economizer Port #2	INT	0 = OFF, 1 = ON	Read		
29	N51:12	40063	Liquid Injection Solenoid #1	INT	0 = OFF, 1 = ON	Read		
30	N51:13	40064	Liquid Injection Solenoid #2	INT	0 = OFF, 1 = ON	Read		
31	N51:14	40065	Remote Enabled	INT	0 = OFF, 1 = ON	Read		
32	N51:15	40066	Emergency Output	INT	0 = OFF, 1 = ON	Read		
33	N51:16	40067	Condenser Step #1	INT	0 = OFF, 1 = ON	Read		
34	N51:17	40068	Condenser Step #2	INT	0 = OFF, 1 = ON	Read		
35	N51:18	40069	Condenser Step #3	INT	0 = OFF, 1 = ON	Read		
36	N51:19	40070	Condenser Step #4	INT	0 = OFF, 1 = ON	Read		
37	N51:20	40071	Auxiliary Output #1	INT	0 = OFF, 1 = ON	Read		
38	N51:21	40072	Auxiliary Output #2	INT	0 = OFF, 1 = ON	Read		
39	N51:22	40073	Auxiliary Output #3	INT	0 = OFF, 1 = ON	Read		
40	N51:23	40074	Auxiliary Output #4	INT	0 = OFF, 1 = ON	Read		
			<b>Analog Inputs</b>					
41	N52:0	40100	Motor Amps	F-INT		Read		
42	N52:1	40101	Suction Pressure	F-INT		Read		
43	N52:2	40102	Discharge Pressure	F-INT		Read		
44	N52:3	40103	Oil Filter Inlet Pressure	F-INT		Read		
45	N52:4	40104	Oil Manifold Pressure	F-INT		Read		
46	N52:5	40105	Economizer Pressure	F-INT		Read		
47	N52:6	40106	Capacity Slide %	F-INT		Read		
48	N52:7	40107	Volume Slide %	F-INT		Read		
49	N52:8	40108	Suction Temperature	F-INT		Read		
50	N52:9	40109	Discharge Temperature	F-INT		Read		
51	N52:10	40110	Oil Separator Temperature	F-INT		Read		
52	N52:11	40111	Oil Manifold Temperature	F-INT		Read		
53	N52:12	40112	Process Control	F-INT		Read		

## Appendix D • Vision 20/20 Communication Table

Vilter™ Address	Ethernet IP Address	Modbus Address	Command Name	Data Type	Value	Mode	Lower Range	Higher Range
54	N52:13	40113	Chiller Inlet Temperature	F-INT		Read		
55	N52:14	40114	Condenser Pressure	F-INT		Read		
56	N52:15	40115	Remote Setpoint	F-INT		Read		
57	N52:16	40116	Auxiliary 1	F-INT		Read		
58	N52:17	40117	Auxiliary 2	F-INT		Read		
59	N52:18	40118	Auxiliary 3	F-INT		Read		
60	N52:19	40119	Auxiliary 4	F-INT		Read		
61	N52:20	40120	Auxiliary 5	F-INT		Read		
62	N52:21	40121	Auxiliary 6	F-INT		Read		
63	N52:22	40122	Auxiliary 7	F-INT		Read		
64	N52:23	40123	Auxiliary 8	F-INT		Read		
65	N52:24	40124	Auxiliary 9	F-INT		Read		
66	N52:25	40125	Auxiliary 10	F-INT		Read		
67	N52:26	40126	Auxiliary 11	F-INT		Read		
68	N52:27	40127	Auxiliary 12	F-INT		Read		
69	N52:28	40128	Auxiliary 13	F-INT		Read		
70	N52:29	40129	Auxiliary 14	F-INT		Read		
71	N52:30	40130	Auxiliary 15	F-INT		Read		
72	N52:31	40131	Auxiliary 16	F-INT		Read		
			<b>Analog Outputs</b>					
73	N53:0	40200	Compressor VFD (mA)	F-INT		Read		
74	N53:1	40201	Condenser VFD	F-INT		Read		
75	N53:2	40202	Slide Valve Output	F-INT		Read		
76	N53:3	40203	Liquid Injection Motorized Valve	F-INT		Read		
77	N53:4	40204	Auxiliary Output #1	F-INT		Read		
78	N53:5	40205	Auxiliary Output #2	F-INT		Read		
79	N53:6	40206	Auxiliary Output #3	F-INT		Read		
80	N53:7	40207	Auxiliary Output #4	F-INT		Read		
			<b>Calculated Values</b>					
81	N54:0	40250	Filter Differential Pressure	F-INT		Read		
82	N54:1	40251	Start Oil Pressure	F-INT		Read		
83	N54:2	40252	Run Oil Pressure	F-INT		Read		
84	N54:3	40253	Pressure Ratio	F-INT		Read		
85	N54:4	40254	Volume Ratio	F-INT		Read		
86	N54:5	40255	Superheat Discharge Temp.	F-INT		Read		

## Appendix D • Vision 20/20 Communication Table

Vilter™ Address	Ethernet IP Address	Modbus Address	Command Name	Data Type	Value	Mode	Lower Range	Higher Range
87	N54:6	40256	Superheat Suction Temp.	F-INT		Read		
88	N54:7	40257	Superheat Oil Sep. Temp.	F-INT	(Currently Unused)	Read		
89	N54:8	40258	Compressor VFD RPM	INT		Read		
90	N54:9	40259	Compressor Run Capacity %	INT		Read		
91	N54:10	40260	Liquid Pressure	F-INT		Read		
92	N54:11	40261	<b>Switch Pressure</b>	F-INT		Read		
93	N54:12	40262	Orifice Loss	F-INT		Read		
			Statuses					
94	N55:0	40400	Anti-Recycle Time (Minutes)	INT		Read		
95	N55:1	40401	Compressor Status	ENUM	"0 = Stop 1 = Stop (Remote Ready) 2 = Running 3 = Starting 4 = Waiting"	Read		
96	N55:2	40402	Alarm Status Word #1	WORD		Read (See Appendix)		
97	N55:3	40403	Alarm Status Word #2	WORD		Read (See Appendix)		
98	N55:4	40404	Warning Status Word #1	WORD		Read (See Appendix)		
99	N55:5	40405	Warning Status Word #2	WORD		Read (See Appendix)		
100	N55:6	40406	Trip Status Word #1	WORD		Read (See Appendix)		
101	N55:7	40407	Trip Status Word #2	WORD		Read (See Appendix)		
102	N55:8	40408	Trip Status Word #3	WORD		Read (See Appendix)		
103	N55:9	40409	Trip Status Word #4	WORD		Read (See Appendix)		

## Appendix D • Vission 20/20 Communication Table

Vilter™ Address	Ethernet IP Address	Modbus Address	Command Name	Data Type	Value	Mode	Lower Range	Higher Range
104	N55:10	40410	Current Run Mode	ENUM	"0 = Idle 1 = Waiting 2 = Starting 3 = Manual 4 = Auto (Internal Capacity Control) 5 = Remote Auto (Internal Capacity Control) 6 = Remote Load/Unload 7 = Remote Capacity Hold % 8 = Remote Ready (Idle) 9 = Direct I/O Auto Capacity 10 = Direct I/O Manual Capacity 11 = Direct I/O Capacity Hold % 12 = Auto Sequencing"	Read		
105	N55:11	40411	Load Limiting Condition	WORD	"Bit 0 = High Motor Amps Bit 1 = High Discharge Pressure Bit 2 = Low Suction Pressure Bit 3 = High Discharge Superheat Bit 4 = Cool Compression SOI Bit 5 = Low Compression Ratio"	Read		
106	N55:12	40412	Oil Pump Status	INT	0 = OFF, 1 = ON	Read		
107	N55:13	40413	Oil Pump Operation	ENUM	"0 = No Pump 1 = Stal 2 = Cycling 3 = Full Time 4 = Cool Compression 5 = Suction Oil Injection Solenoid"	Read		
108	N55:14	40414	Compressor Model	ENUM	"0 = VSR 1 = VSM 2 = VSS 3 = VRS 4 = VSM7"	Read		
109	N55:15	40415	Refrigerant	ENUM	"0 = R12 1 = R22 2 = R134a 3 = R290 4 = R404a 5 = R502 6 = R507 7 = R717 8 = R744 9 = Natural Gas"	Read		
110	N55:16	40416	Runtime Hours (x1000)	INT		Read		

## Appendix D • Vision 20/20 Communication Table

Vilter™ Address	Ethernet IP Address	Modbus Address	Command Name	Data Type	Value	Mode	Lower Range	Higher Range
111	N55:17	40417	Runtime Hours (1-999)	INT		Read		
112	N55:18	40418	Remote Lock Mode	INT	0 = OFF, 1 = ON	Read		
			Commands					
113	N56:0	40500	Alarm Reset	INT	1 = Perform Reset	Read-Write		
114	N56:1	40501	Active Remote Control	ENUM	"0 = None (Local) 1 = Direct I/O 2 = Serial 3 = Ethernet"	Read-Write		
115	N56:2	40502	Remote Capacity Control Select	ENUM	"0 = Auto Capacity Control 1 = Pulse Load / Unload 2 = Hold Capacity %"	Read-Write		
116	N56:3	40503	Auto Capacity Control Type	ENUM	"0 = Suction Pressure (if enabled) 1 = Process Control (if enabled) 2 = Discharge Pressure (if enabled)"	Read-Write		
117	N56:4	40504	Remote Pulse Load	F-INT	"0 = Stop Pulse 10 = 1 Second Pulse 15 = 1.5 Second Pulse 20 = 2 Second Pulse ... 145 = 14.5 Second Pulse 150 = 15 Second Pulse"	Read-Write		
118	N56:5	40505	Remote Pulse Unload	F-INT	"0 = Stop Pulse 10 = 1 Second Pulse 15 = 1.5 Second Pulse 20 = 2 Second Pulse ... 145 = 14.5 Second Pulse 150 = 15 Second Pulse"	Read-Write		
119	N56:6	40506	Capacity Hold %	INT	0 – 100	Read-Write		
120	N56:7	40507	Active Setpoint	ENUM	"1 = Setpoint 1 2 = Setpoint 2 (if enabled)"	Read-Write		
121	N56:8	40508	Start Command	INT	"1 = Remote Auto 2 = Auto Sequencing"	Read-Write (See Appendix)		
122	N56:9	40509	Stop Command	INT	1 = Stop	Read-Write		
123	N56:10	40510	Auto-Cycle Enable/Disable	INT	0 = Disable, 1 = Enable	Read-Write		
124	N56:11	40511	Pumpdown Enable/Disable	INT	0 = Disable, 1 = Enable	Read-Write		
125	N56:12	40512	Pulldown Enable/Disable	INT	0 = Disable, 1 = Enable	Read-Write		

## Appendix D • Vision 20/20 Communication Table

Vilter™ Address	Ethernet IP Address	Modbus Address	Command Name	Data Type	Value	Mode	Lower Range	Higher Range
126	N56:13	40513	<b>Force to local control</b>	INT	1 = To local	Read-Write		
			Compressor Control Setpoints					
127	N57:0	40550	Setpoint #1 (Suct. Press, Proc Control, Disch. Press)	F-INT		Read-Write	(-15.0, -100.0, -15.0)	(200.0, 150.0, 400.0)
128	N57:1	40551	Cap Inc Time Interval Setpoint #1	F-INT		Read-Write	0.5	5.5
129	N57:2	40552	Cap Inc Proportional Band Setpoint #1	F-INT		Read-Write	0.5	20.0
130	N57:3	40553	Cap Dec Time Interval Setpoint #1	F-INT		Read-Write	0.5	5.5
131	N57:4	40554	Cap Dec Proportional Band Setpoint #1	F-INT		Read-Write	0.5	20.0
132	N57:5	40555	Setpoint #2 (Suct. Press, Proc Control, Disch. Press)	F-INT		Read-Write	(-15.0, -100.0, -15.0)	(200.0, 150.0, 400.0)
133	N57:6	40556	Cap Inc Time Interval Setpoint #2	F-INT		Read-Write	0.5	5.5
134	N57:7	40557	Cap Inc Proportional Band Setpoint #2	F-INT		Read-Write	0.5	20.0
135	N57:8	40558	Cap Dec Time Interval Setpoint #2	F-INT		Read-Write	0.5	5.5
136	N57:9	40559	Cap Dec Proportional Band Setpoint #2	F-INT		Read-Write	0.5	20.0
137	N57:10	40560	Cap Inc Pulse Time Setpoint #1	F-INT		Read-Write	0.5	5.5
138	N57:11	40561	Cap Inc Dead Band Setpoint #1	F-INT		Read-Write	1.0	50.0
139	N57:12	40562	Cap Dec Pulse Time Setpoint #1	F-INT		Read-Write	0.5	5.5
140	N57:13	40563	Cap Dec Dead Band Setpoint #1	F-INT		Read-Write	1.0	50.0
141	N57:14	40564	Cap Inc Pulse Time Setpoint #2	F-INT		Read-Write	0.5	5.5
142	N57:15	40565	Cap Inc Dead Band Setpoint #2	F-INT		Read-Write	1.0	50.0
143	N57:16	40566	Cap Dec Pulse Time Setpoint #2	F-INT		Read-Write	0.5	5.5
144	N57:17	40567	<b>Cap Dec Dead Band Setpoint #2</b>	F-INT		Read-Write	1.0	50.0
			Auto Cycle					
145	N58:0	40570	Start(Suct. Press/Proc Control/Disch. Press) Setpoint #1	F-INT		Read-Write	(-15.0, -100.0, -15.0)	(200.0, 150.0, 400.0)

## Appendix D • Vission 20/20 Communication Table

Vilter™ Address	Ethernet IP Address	Modbus Address	Command Name	Data Type	Value	Mode	Lower Range	Higher Range
146	N58:1	40571	Start Delay Time Setpoint #1	INT		Read-Write	0	300
147	N58:2	40572	Stop(Suct. Press/Proc Control/Disch. Press) Setpoint #1	F-INT		Read-Write	(-15.0, -100.0, -15.0)	(200.0, 150.0, 400.0)
148	N58:3	40573	Stop Delay Time Setpoint #1	INT		Read-Write	0	300
149	N58:4	40574	Minimum Slide Position Setpoint #1	INT		Read-Write	0	100
150	N58:5	40575	Start(Suct. Press/Proc Control/Disch. Press) Setpoint #2	F-INT		Read-Write	(-15.0, -100.0, -15.0)	(200.0, 150.0, 400.0)
151	N58:6	40576	Start Delay Time Setpoint #2	INT		Read-Write	0	300
152	N58:7	40577	Stop(Suct. Press/Proc Control/Disch. Press) Setpoint #2	F-INT		Read-Write	(-15.0, -100.0, -15.0)	(200.0, 150.0, 400.0)
153	N58:8	40578	Stop Delay Time Setpoint #2	INT		Read-Write	0	300
154	N58:9	40579	<b>Minimum Slide Position Setpoint #2</b>	INT		Read-Write	0	100
			Pumpdown					
155	N59:0	40590	Stop Pressure Setpoint #1	F-INT		Read-Write	-15.0	200.0
156	N59:1	40591	Stop Delay Time Setpoint #1 (seconds)	INT		Read-Write	0	60
157	N59:2	40592	Minimum Slide Position Setpoint #1	INT		Read-Write	0	50
158	N59:3	40593	Stop Pressure Setpoint #2	F-INT		Read-Write	-15.0	200.0
159	N59:4	40594	Stop Delay Time Setpoint #2 (seconds)	INT		Read-Write	0	60
160	N59:5	40595	Minimum Slide Position Setpoint #2	INT		Read-Write	0	50
161	N59:6	40596	<b>Pumpdown Operation</b>	INT	0 = Stop, 1 = Start	Read-Write		
			Pulldown					
162	N60:0	40600	Step Pressure	F-INT		Read-Write	0.0	10.0
163	N60:1	40601	Delay Per Step (hours and minutes)	F-INT		Read-Write	1	1259
164	N60:2	40602	Stop Pressure	F-INT		Read-Write	-15.0	200.0
165	N60:3	40603	Auto Cycle Differential	F-INT		Read-Write	1.0	20.0
166	N60:4	40604	<b>Initiate Pulldown at Next Start</b>	INT	0 = Disable, 1 = Enable	Read-Write		
167	N60:5	40605	Initiate Pulldown at Every Start	INT	0 = Disable, 1 = Enable	Read-Write		



## Appendix D • Vision 20/20 Communication Table

Vilter™ Address	Ethernet IP Address	Modbus Address	Command Name	Data Type	Value	Mode	Lower Range	Higher Range
			Stop Load & Force Unload / Liquid Injection					
168	N61:0	40610	High Motor Amps Stop Load Setpoint #1	F-INT		Read		
169	N61:1	40611	High Motor Amps Force Unload Setpoint #1	F-INT		Read		
170	N61:2	40612	High Disch Press Stop Load Setpoint #1	F-INT		Read		
171	N61:3	40613	High Disch Press Force Unload Setpoint #1	F-INT		Read		
172	N61:4	40614	Low Suct Press Stop Load Setpoint #1	F-INT		Read		
173	N61:5	40615	Low Suct Press Force Unload Setpoint #1	F-INT		Read		
174	N61:6	40616	High Motor Amps Stop Load Setpoint #2	F-INT		Read		
175	N61:7	40617	High Motor Amps Force Unload Setpoint #2	F-INT		Read		
176	N61:8	40618	High Disch Press Stop Load Setpoint #2	F-INT		Read		
177	N61:9	40619	High Disch Press Force Unload Setpoint #2	F-INT		Read		
178	N61:10	40620	Low Suct Press Stop Load Setpoint #2	F-INT		Read		
179	N61:11	40621	Low Suct Press Force Unload Setpoint #2	F-INT		Read		
180	N61:12	40622	Liquid Inj. Setpoint	F-INT		Read-Write		
181	N61:13	40623	Dual Liquid Inj. Enabled	INT	0 = Disabled, 1 = Enabled	Read		
182	N61:14	40624	Liquid Inj. Open %	F-INT		Read		
183	N61:15	40625	Liquid Inj. Oil Sep. Temp. Override	F-INT		Read		
184	N61:16	40626	Liquid Inj. Motorized Valve Gain (P)	F-INT		Read		
185	N61:17	40627	Liquid Inj. Motorized Valve Reset (I)	F-INT		Read		
186	N61:18	40628	Liquid Inj. Motorized Valve Rate (D)	F-INT		Read		
187	N61:19	40629	Minimum Valve Open Enabled	INT	0 = Disabled, 1 = Enabled	Read		
188	N61:20	40630	Avg. With Oil Manifold Temperature	INT	0 = Disabled, 1 = Enabled	Read		
189	N61:21	40631	High Discharge Superheat Stop Load Setpoint #1	F-INT		Read		
190	N61:22	40632	High Discharge Superheat Force Unload Setpoint #1	F-INT		Read		

## Appendix D • Vision 20/20 Communication Table

Vilter™ Address	Ethernet IP Address	Modbus Address	Command Name	Data Type	Value	Mode	Lower Range	Higher Range
191	N61:23	40633	High Discharge Superheat Stop Load Setpoint #2	F-INT		Read		
Vilter™ Address	Ethernet IP Address	Modbus Address	Command Name	Data Type	Value	Mode	Lower Range	Higher Range
192	N61:24	40634	High Discharge Superheat Force Unload Setpoint #2	F-INT		Read		
193	N61:25	40635	Dual Liquid Inj. Slide %	F-INT		Read		
194	N61:26	40636	Dual Liquid Inj. Valve Loss	F-INT		Read		
195	N61:27	40637	Dual Liquid Inj. Safety Loss	F-INT		Read		
196	N61:28	40638	Dual Liquid Inj. Port Selection	ENUM	"0 = Low-Medium 1 = Low-High 2 = Medium-High"	Read		
			Slide Valve Control / Oil Control					
197	N62:0	40640	Slide Valve Setpoint #1	INT		Read		
198	N62:1	40641	Slide Valve Setpoint #2	INT		Read		
199	N62:2	40642	Slide Valve Setpoint #1 Enabled	INT	0 = Disabled, 1 = Enabled	Read		
200	N62:3	40643	Slide Valve Setpoint #2 Enabled	INT	0 = Disabled, 1 = Enabled	Read		
201	N62:4	40644	Oil Pump Press. Restart Ratio (ON)	F-INT		Read		
202	N62:5	40645	Oil Pump Press. Restart Ratio (OFF)	F-INT		Read		
203	N62:6	40646	Oil Sep. Heater Temp.	F-INT		Read		
204	N62:7	40647	<b>Volume Slide Adjustment %</b>	INT		Read		
205	N62:8	40648	Soft Load %	INT		Read		
206	N62:9	40649	Capacity Range Min %	F-INT		Read		
207	N62:10	40650	Capacity Range Max %	F-INT		Read		
208	N62:11	40651	Rate Deadband	F-INT		Read		
209	N62:12	40652	Enable Load Anticipating Algorithm	INT	0 = Disabled, 1 = Enabled	Read		
210	N62:13	40653	Economizer Port 2 Setpoint	INT		Read		
211	N62:14	40654	Oil Injection Temperature Override	F-INT		Read		
212	N62:15	40655	Slide Valve Setpoint #1 State Below Setpoint	INT	0 = N.O., 1 = N.C.	Read		

## Appendix D • Vission 20/20 Communication Table

Vilter™ Address	Ethernet IP Address	Modbus Address	Command Name	Data Type	Value	Mode	Lower Range	Higher Range
213	N62:16	40656	Slide Valve Setpoint #2 State Below Setpoint	INT	0 = N.O., 1 = N.C.	Read		
214	N62:17	40657	No Oil Pump Pressure Ratio	F-INT		Read		
215	N62:18	40658	No Oil Pump Load Limit %	F-INT		Read		
			Compressor VFD					
216	N70:0	40670	<b>VFD Gain (P)</b>	F-INT		Read		
217	N70:1	40671	VFD Reset (I)	F-INT		Read		
218	N70:2	40672	VFD Rate (D)	F-INT		Read		
219	N70:3	40673	Step 1 VFD Minimum Slide Position	INT		Read		
220	N70:4	40674	Step 1 VFD Maximum Slide Position	INT		Read		
221	N70:5	40675	Step 1 VFD Minimum Speed (rpm)	INT		Read		
222	N70:6	40676	Step 1 VFD Maximum Speed (rpm)	INT		Read		
223	N70:7	40677	2 Step VFD Control Enabled	INT	0 = Disabled, 1 = Enabled	Read		
224	N70:8	40678	Step 2 VFD Minimum Slide Position	INT		Read		
225	N70:9	40679	Step 2 VFD Maximum Slide Position	INT		Read		
226	N70:10	40680	Step 2 VFD Minimum Speed (rpm)	INT		Read		
227	N70:11	40681	Step 2 VFD Maximum Speed (rpm)	INT		Read		
228	N70:12	40682	Rapid Cycling VFD Minimum Speed (rpm)	INT		Read		
229	N70:13	40683	Rapid Cycling VFD Maximum Speed (rpm)	INT		Read		
230	N70:14	40684	Warm up Timer	F-INT		Read		
231	N70:15	40685	Oil Restriction Setpoint (rpm)	INT		Read		
232	N70:16	40686	<b>Oil Restriction Offset (rpm)</b>	INT		Read		
233	N70:17	40687	<b>Oil Restriction Solenoid State Below Setpoint</b>	INT	0 = "N.O.", 1 = "N.C."	Read		
			Cool Compression					
234	N71:0	40700	Auto Load Enabled	INT	0 = Disabled, 1 = Enabled	Read		
235	N71:1	40701	Auto Load @ Start	INT		Read		
236	N71:2	40702	Auto Load Timer (mins)	F-INT		Read		

## Appendix D • Vision 20/20 Communication Table

Vilter™ Address	Ethernet IP Address	Modbus Address	Command Name	Data Type	Value	Mode	Lower Range	Higher Range
237	N71:3	40703	SOI Solenoid ON	F-INT		Read		
238	N71:4	40704	SOI Solenoid OFF	F-INT		Read		
239	N71:5	40705	SOI Load Limit	INT		Read		
240	N71:6	40706	High Press Ratio Solenoid ON	F-INT		Read		
241	N71:7	40707	High Press Ratio Solenoid OFF	F-INT		Read		
242	N71:8	40708	Start SP	F-INT		Read		
243	N71:9	40709	Linear SP	F-INT		Read		
244	N71:10	40710	Upper SP	F-INT		Read		
245	N71:11	40711	Max SP	F-INT		Read		
246	N71:12	40712	Start Level	INT		Read		
247	N71:13	40713	<b>Leakage</b>	INT		Read		
248	N71:14	40714	Overfill Leakage	INT		Read		
			VI Control					
249	N74:0	40720	VI Control Method	ENUM	"0 = Fixed VI 1 = Continuous VI 2 = Step VI"	Read		
250	N74:1	40721	Time Interval	INT		Read		
251	N74:2	40722	Minimum VI	F-INT		Read		
252	N74:3	40723	Maximum VI	F-INT		Read		
253	N74:4	40724	Deadband	F-INT		Read		
254	N74:5	40725	Step 1	F-INT		Read		
255	N74:6	40726	Step 2	F-INT		Read		
256	N74:7	40727	Step 3	F-INT		Read		
			Alarms/Trips (Page 1)					
257	N63:0	40750	Low Suction Press. Alarm Setpoint #1	F-INT		Read-Write	-15.0	300.0
258	N63:1	40751	Low Suction Press. Trip Setpoint #1	F-INT		Read-Write	-15.0	300.0
259	N63:2	40752	High Disch. Press. Alarm Setpoint #1	F-INT		Read		
260	N63:3	40753	High Disch. Press. Trip Setpoint #1	F-INT		Read		
261	N63:4	40754	High Proc. Temp. Alarm Setpoint #1	F-INT		Read-Write	-100.0	210.0
262	N63:5	40755	Low Proc. Temp. Alarm Setpoint #1	F-INT		Read-Write	-100.0	210.0
263	N63:6	40756	<b>Low Proc. Temp. Trip Setpoint #1</b>	F-INT		Read-Write	-100.0	210.0
264	N63:7	40757	Low Suction Press. Alarm Setpoint #2	F-INT		Read-Write	-15.0	300.0

## Appendix D • Vision 20/20 Communication Table

Vilter™ Address	Ethernet IP Address	Modbus Address	Command Name	Data Type	Value	Mode	Lower Range	Higher Range
265	N63:8	40758	Low Suction Press. Trip Setpoint #2	F-INT		Read-Write	-15.0	300.0
266	N63:9	40759	High Disch. Press. Alarm Setpoint #2	F-INT		Read		
267	N63:10	40760	High Disch. Press. Trip Setpoint #2	F-INT		Read		
268	N63:11	40761	High Proc. Temp. Alarm Setpoint #2	F-INT		Read-Write	-100.0	210.0
269	N63:12	40762	Low Proc. Temp. Alarm Setpoint #2	F-INT		Read-Write	-100.0	210.0
270	N63:13	40763	Low Proc. Temp. Trip Setpoint #2	F-INT		Read-Write	-100.0	210.0
271	N63:14	40764	Low Proc. Pressure Alarm Setpoint #1	F-INT		Read-Write	-15.0	300.0
272	N63:15	40765	Low Proc. Pressure Trip Setpoint #1	F-INT		Read-Write	-15.0	300.0
273	N63:16	40766	High Proc. Pressure Alarm Setpoint #1	F-INT		Read-Write	-15.0	400.0
274	N63:17	40767	High Proc. Pressure Trip Setpoint #1	F-INT		Read-Write	-15.0	400.0
275	N63:18	40768	Low Proc. Pressure Alarm Setpoint #2	F-INT		Read-Write	-15.0	300.0
276	N63:19	40769	Low Proc. Pressure Trip Setpoint #2	F-INT		Read-Write	-15.0	300.0
277	N63:20	40770	<b>High Proc. Pressure Alarm Setpoint #2</b>	F-INT		Read-Write	-15.0	400.0
278	N63:21	40771	High Proc. Pressure Trip Setpoint #2	F-INT		Read-Write	-15.0	400.0
			Alarms/Trips (Page 2)					
279	N64:0	40800	Low Suction Temp. Alarm	F-INT		Read-Write	-100.0	210.0
280	N64:1	40801	Low Suction Temp. Trip	F-INT		Read-Write	-100.0	210.0
281	N64:2	40802	High Disch. Temp. Alarm	F-INT		Read		
282	N64:3	40803	High Disch. Temp. Trip	F-INT		Read		
283	N64:4	40804	Low Oil Sep. Start Temp. Alarm	F-INT		Read		
284	N64:5	40805	Low Oil Sep. Start Temp. Trip	F-INT		Read		
285	N64:6	40806	Low Oil Sep. Run Temp. Alarm	F-INT		Read		
286	N64:7	40807	Low Oil Sep. Run Temp. Trip	F-INT		Read		
287	N64:8	40808	Low Oil Inj. Temp Alarm	F-INT		Read		
288	N64:9	40809	Low Oil Inj. Temp Trip	F-INT		Read		
289	N64:10	40810	High Oil Inj. Temp Alarm	F-INT		Read		

## Appendix D • Vision 20/20 Communication Table

Vilter™ Address	Ethernet IP Address	Modbus Address	Command Name	Data Type	Value	Mode	Lower Range	Higher Range
290	N64:11	40811	High Oil Inj. Temp Trip	F-INT		Read		
291	N64:12	40812	High Oil Separator Temp Alarm	F-INT		Read		
292	N64:13	40813	High Oil Separator Temp Trip	F-INT		Read		
293	N64:14	40814	High Superheat Start Temp Trip	F-INT		Read-Write	0.0	100.0
294	N64:15	40815	High Superheat Run Temp Alarm	F-INT		Read-Write	21.0	23.0
295	N64:16	40816	<b>High Superheat Run Temp Trip</b>	F-INT		Read-Write	24.0	26.0
296	N64:17	40817	High Superheat Start Offset Temp	F-INT		Read-Write	4.0	6.0
297	N64:18	40818	Low Suction Superheat Temp Alarm	F-INT		Read-Write	0.0	40.0
298	N64:19	40819	Low Suction Superheat Temp Trip	F-INT		Read-Write	0.0	40.0
			Alarms/Trips (Page 3)					
299	N65:0	40830	Prelube Oil Pressure Alarm	F-INT		Read		
300	N65:1	40831	Prelube Oil Pressure Trip	F-INT		Read		
301	N65:2	40832	Run Oil Pressure Alarm	F-INT		Read		
302	N65:3	40833	Run Oil Pressure Trip	F-INT		Read		
303	N65:4	40834	High Filter Diff. Start Press. Alarm	F-INT		Read		
304	N65:5	40835	High Filter Diff. Start Press. Trip	F-INT		Read		
305	N65:6	40836	High Filter Diff. Run Press. Alarm	F-INT		Read		
306	N65:7	40837	High Filter Diff. Run Press. Trip	F-INT		Read		
307	N65:8	40838	High Motor Amps Alarm	F-INT		Read		
308	N65:9	40839	High Motor Amps Trip	F-INT		Read		
309	N65:10	40840	Low Run Pressure Ratio Alarm	F-INT		Read-Write	1.4	4.9
310	N65:11	40841	Low Run Pressure Ratio Trip	F-INT		Read-Write	1.4	4.9
311	N65:12	40842	Start Oil Pressure Stage 1 Trip	F-INT		Read		
312	N65:13	40843	Start Oil Pressure Stage 2 Trip	F-INT		Read		
313	N65:14	40844	Oil Over Pressure Trip	F-INT		Read		

## Appendix D • Vision 20/20 Communication Table

Vilter™ Address	Ethernet IP Address	Modbus Address	Command Name	Data Type	Value	Mode	Lower Range	Higher Range
			Timers					
314	N66:0	40900	Capacity Increase Start Delay (seconds)	INT		Read		
315	N66:1	40901	Minimum Comp. Prelube Time (seconds)	INT		Read		
316	N66:2	40902	Low Oil Press. Safety Changeover (seconds)	INT		Read		
317	N66:3	40903	High Filter Diff. Safety Changeover (seconds)	INT		Read		
318	N66:4	40904	Compressor Interlock Bypass (seconds)	INT		Read		
319	N66:5	40905	Low Oil Sep. Temp Safety Changeover (minutes)	INT		Read		
320	N66:6	40906	Low Oil Injection Safety Changeover (minutes)	INT		Read		
321	N66:7	40907	High Motor Amps Safety Changeover (seconds)	INT		Read		
322	N66:8	40908	Max Restart Time After Power Failure (minutes)	INT		Read-Write	1	120
323	N66:9	40909	Hot Starts Per Hour	INT		Read-Write	1	5
324	N66:10	40910	True Anti-Recycle Timer (minutes)	INT		Read-Write	12	480
325	N66:11	40911	Accumulative Anti-Recycle Timer (minutes)	INT		Read-Write	12	480
326	N66:12	40912	Oil Level #1 Safety Trip Delay (seconds)	INT		Read		
327	N66:13	40913	Oil Level #2 Safety Trip Delay (seconds)	INT		Read		
328	N66:14	40914	Low Pressure Ratio Bypass (seconds)	INT		Read		
329	N66:15	40915	Emergency Stop Timer (minutes)	INT		Read		
330	N66:16	40916	Low Suction Pressure Safety Bypass (seconds)	INT		Read		
331	N66:17	40917	High Superheat Temp Safety Changeover (minutes)	INT		Read		
332	N66:18	40918	Prelube Oil Pressure Monitor Time (seconds)	INT		Read		
333	N66:19	40919	Prelube Oil Pressure Monitor Trials	INT		Read		
334	N66:20	40920	Prelube Oil Pressure Safety Changeover (seconds)	INT		Read		
335	N66:21	40921	Communication Failure Detect Timer (minutes)	INT		Read		

## Appendix D • Vision 20/20 Communication Table

Vilter™ Address	Ethernet IP Address	Modbus Address	Command Name	Data Type	Value	Mode	Lower Range	Higher Range
336	N66:22	40922	Start Oil Pressure Stage 1 Safety Timer	INT		Read		
337	N66:23	40923	Start Oil Pressure Stage 2 Safety Timer	INT		Read		
			Compressor Scheduling (Military Time)					
338	N67:0	41000	Sunday Event #1 Control Mode	ENUM		Read-Write (See Appendix)	0	6
339	N67:1	41001	Sunday Event #1 Hour	INT		Read-Write (See Appendix)	0	23
340	N67:2	41002	Sunday Event #1 Minute	INT		Read-Write (See Appendix)	0	59
341	N67:3	41003	Sunday Event #2 Control Mode	ENUM		Read-Write (See Appendix)	0	6
342	N67:4	41004	Sunday Event #2 Hour	INT		Read-Write (See Appendix)	0	23
343	N67:5	41005	Sunday Event #2 Minute	INT		Read-Write (See Appendix)	0	59
344	N67:6	41006	Sunday Event #3 Control Mode	ENUM		Read-Write (See Appendix)	0	6
345	N67:7	41007	Sunday Event #3 Hour	INT		Read-Write (See Appendix)	0	23
346	N67:8	41008	Sunday Event #3 Minute	INT		Read-Write (See Appendix)	0	59
347	N67:9	41009	Sunday Event #4 Control Mode	ENUM		Read-Write (See Appendix)	0	6
348	N67:10	41010	Sunday Event #4 Hour	INT		Read-Write (See Appendix)	0	23
349	N67:11	41011	Sunday Event #4 Minute	INT		Read-Write (See Appendix)	0	59
350	N67:12	41012	Monday Event #1 Control Mode	ENUM		Read-Write (See Appendix)	0	6
351	N67:13	41013	Monday Event #1 Hour	INT		Read-Write (See Appendix)	0	23



## Appendix D • Vision 20/20 Communication Table

Vilter™ Address	Ethernet IP Address	Modbus Address	Command Name	Data Type	Value	Mode	Lower Range	Higher Range
352	N67:14	41014	Monday Event #1 Minute	INT		Read-Write (See Appendix)	0	59
353	N67:15	41015	Monday Event #2 Control Mode	ENUM		Read-Write (See Appendix)	0	6
354	N67:16	41016	Monday Event #2 Hour	INT		Read-Write (See Appendix)	0	23
355	N67:17	41017	Monday Event #2 Minute	INT		Read-Write (See Appendix)	0	59
356	N67:18	41018	Monday Event #3 Control Mode	ENUM		Read-Write (See Appendix)	0	6
357	N67:19	41019	Monday Event #3 Hour	INT		Read-Write (See Appendix)	0	23
358	N67:20	41020	Monday Event #3 Minute	INT		Read-Write (See Appendix)	0	59
359	N67:21	41021	Monday Event #4 Control Mode	ENUM		Read-Write (See Appendix)	0	6
360	N67:22	41022	Monday Event #4 Hour	INT		Read-Write (See Appendix)	0	23
361	N67:23	41023	Monday Event #4 Minute	INT		Read-Write (See Appendix)	0	59
362	N67:24	41024	Tuesday Event #1 Control Mode	ENUM		Read-Write (See Appendix)	0	6
363	N67:25	41025	Tuesday Event #1 Hour	INT		Read-Write (See Appendix)	0	23
364	N67:26	41026	Tuesday Event #1 Minute	INT		Read-Write (See Appendix)	0	59
365	N67:27	41027	Tuesday Event #2 Control Mode	ENUM		Read-Write (See Appendix)	0	6
366	N67:28	41028	Tuesday Event #2 Hour	INT		Read-Write (See Appendix)	0	23
367	N67:29	41029	Tuesday Event #2 Minute	INT		Read-Write (See Appendix)	0	59
368	N67:30	41030	Tuesday Event #3 Control Mode	ENUM		Read-Write (See Appendix)	0	6

## Appendix D • Vission 20/20 Communication Table

Vilter™ Address	Ethernet IP Address	Modbus Address	Command Name	Data Type	Value	Mode	Lower Range	Higher Range
369	N67:31	41031	Tuesday Event #3 Hour	INT		Read-Write (See Appendix)	0	23
370	N67:32	41032	Tuesday Event #3 Minute	INT		Read-Write (See Appendix)	0	59
371	N67:33	41033	Tuesday Event #4 Control Mode	ENUM		Read-Write (See Appendix)	0	6
372	N67:34	41034	Tuesday Event #4 Hour	INT		Read-Write (See Appendix)	0	23
373	N67:35	41035	Tuesday Event #4 Minute	INT		Read-Write (See Appendix)	0	59
374	N67:36	41036	Wednesday Event #1 Control Mode	ENUM		Read-Write (See Appendix)	0	6
375	N67:37	41037	Wednesday Event #1 Hour	INT		Read-Write (See Appendix)	0	23
376	N67:38	41038	Wednesday Event #1 Minute	INT		Read-Write (See Appendix)	0	59
377	N67:39	41039	Wednesday Event #2 Control Mode	ENUM		Read-Write (See Appendix)	0	6
378	N67:40	41040	Wednesday Event #2 Hour	INT		Read-Write (See Appendix)	0	23
379	N67:41	41041	Wednesday Event #2 Minute	INT		Read-Write (See Appendix)	0	59
380	N67:42	41042	Wednesday Event #3 Control Mode	ENUM		Read-Write (See Appendix)	0	6
381	N67:43	41043	Wednesday Event #3 Hour	INT		Read-Write (See Appendix)	0	23
382	N67:44	41044	Wednesday Event #3 Minute	INT		Read-Write (See Appendix)	0	59
383	N67:45	41045	Wednesday Event #4 Control Mode	ENUM		Read-Write (See Appendix)	0	6
384	N67:46	41046	Wednesday Event #4 Hour	INT		Read-Write (See Appendix)	0	23
385	N67:47	41047	Wednesday Event #4 Minute	INT		Read-Write (See Appendix)	0	59

## Appendix D • Vision 20/20 Communication Table

Vilter™ Address	Ethernet IP Address	Modbus Address	Command Name	Data Type	Value	Mode	Lower Range	Higher Range
386	N67:48	41048	Thursday Event #1 Control Mode	ENUM		Read-Write (See Appendix)	0	6
387	N67:49	41049	Thursday Event #1 Hour	INT		Read-Write (See Appendix)	0	23
388	N67:50	41050	Thursday Event #1 Minute	INT		Read-Write (See Appendix)	0	59
389	N67:51	41051	Thursday Event #2 Control Mode	ENUM		Read-Write (See Appendix)	0	6
390	N67:52	41052	Thursday Event #2 Hour	INT		Read-Write (See Appendix)	0	23
391	N67:53	41053	Thursday Event #2 Minute	INT		Read-Write (See Appendix)	0	59
392	N67:54	41054	Thursday Event #3 Control Mode	ENUM		Read-Write (See Appendix)	0	6
393	N67:55	41055	Thursday Event #3 Hour	INT		Read-Write (See Appendix)	0	23
394	N67:56	41056	Thursday Event #3 Minute	INT		Read-Write (See Appendix)	0	59
395	N67:57	41057	Thursday Event #4 Control Mode	ENUM		Read-Write (See Appendix)	0	6
396	N67:58	41058	Thursday Event #4 Hour	INT		Read-Write (See Appendix)	0	23
397	N67:59	41059	Thursday Event #4 Minute	INT		Read-Write (See Appendix)	0	59
398	N67:60	41060	Friday Event #1 Control Mode	ENUM		Read-Write (See Appendix)	0	6
399	N67:61	41061	Friday Event #1 Hour	INT		Read-Write (See Appendix)	0	23
400	N67:62	41062	Friday Event #1 Minute	INT		Read-Write (See Appendix)	0	59
401	N67:63	41063	Friday Event #2 Control Mode	ENUM		Read-Write (See Appendix)	0	6
402	N67:64	41064	Friday Event #2 Hour	INT		Read-Write (See Appendix)	0	23

## Appendix D • Vision 20/20 Communication Table

Vilter™ Address	Ethernet IP Address	Modbus Address	Command Name	Data Type	Value	Mode	Lower Range	Higher Range
403	N67:65	41065	Friday Event #2 Minute	INT		Read-Write (See Appendix)	0	59
404	N67:66	41066	Friday Event #3 Control Mode	ENUM		Read-Write (See Appendix)	0	6
405	N67:67	41067	Friday Event #3 Hour	INT		Read-Write (See Appendix)	0	23
406	N67:68	41068	Friday Event #3 Minute	INT		Read-Write (See Appendix)	0	59
407	N67:69	41069	Friday Event #4 Control Mode	ENUM		Read-Write (See Appendix)	0	6
408	N67:70	41070	Friday Event #4 Hour	INT		Read-Write (See Appendix)	0	23
409	N67:71	41071	Friday Event #4 Minute	INT		Read-Write (See Appendix)	0	59
410	N67:72	41072	Saturday Event #1 Control Mode	ENUM		Read-Write (See Appendix)	0	6
411	N67:73	41073	Saturday Event #1 Hour	INT		Read-Write (See Appendix)	0	23
412	N67:74	41074	Saturday Event #1 Minute	INT		Read-Write (See Appendix)	0	59
413	N67:75	41075	Saturday Event #2 Control Mode	ENUM		Read-Write (See Appendix)	0	6
414	N67:76	41076	Saturday Event #2 Hour	INT		Read-Write (See Appendix)	0	23
415	N67:77	41077	Saturday Event #2 Minute	INT		Read-Write (See Appendix)	0	59
416	N67:78	41078	Saturday Event #3 Control Mode	ENUM		Read-Write (See Appendix)	0	6
417	N67:79	41079	Saturday Event #3 Hour	INT		Read-Write (See Appendix)	0	23
418	N67:80	41080	Saturday Event #3 Minute	INT		Read-Write (See Appendix)	0	59
419	N67:81	41081	Saturday Event #4 Control Mode	ENUM		Read-Write (See Appendix)	0	6

## Appendix D • Vision 20/20 Communication Table

Vilter™ Address	Ethernet IP Address	Modbus Address	Command Name	Data Type	Value	Mode	Lower Range	Higher Range
420	N67:82	41082	Saturday Event #4 Hour	INT		Read-Write (See Appendix)	0	23
421	N67:83	41083	Saturday Event #4 Minute	INT		Read-Write (See Appendix)	0	59
422	N67:84	41084	Comp Schedule Enable/Disable	INT	0 = Disable, 1 = Enable	Read-Write (See Appendix)		
			Compressor Sequencing					
423	N68:0	41100	Control Setpoint (Suct. Press, Process, Disch. Press)	F-INT		Read		
424	N68:1	41101	Start Offset (Suct. Press, Process, Disch. Press)	F-INT		Read-Write	0.0	100.0
425	N68:2	41102	Fast Load Offset (Suct. Press, Process, Disch. Press)	F-INT		Read-Write	0.0	100.0
426	N68:3	41103	Fast Unload Offset (Suct. Press, Process, Disch. Press)	F-INT		Read-Write	0.0	100.0
427	N68:4	41104	Slow Load Timer (Suct. Press, Process, Disch. Press) (sec)	INT		Read-Write	0	10000
428	N68:5	41105	Fast Load Timer (Suct. Press, Process, Disch. Press) (sec)	INT		Read-Write	0	10000
429	N68:6	41106	Slow Unload Timer (Suct. Press, Proc., Disch. Press) (sec)	INT		Read-Write	0	10000
430	N68:7	41107	Fast Unload Timer (Suct. Press, Proc., Disch. Press) (sec)	INT		Read-Write	0	10000
431	N68:8	41108	Min Trigger	INT		Read-Write	0	100
432	N68:9	41109	Max Trigger	INT		Read-Write	0	100
433	N68:10	41110	Machine Start Time (sec)	INT		Read-Write	0	1000
434	N68:11	41111	Machine Stop Time (sec)	INT		Read-Write	0	1000
435	N68:12	41112	Accelerated Shut Down Time (sec)	INT		Read-Write	0	1000
			<b>Condenser Control</b>					
436	N69:0	41170	Run Mode	ENUM	"0 = Run Never 1 = Run With Comp 2 = Run Always 3 = Manual"	Read-Write		

## Appendix D • Vision 20/20 Communication Table

Vilter™ Address	Ethernet IP Address	Modbus Address	Command Name	Data Type	Value	Mode	Lower Range	Higher Range
437	N69:1	41171	Profile	ENUM	"0 = Summer 1 = Winter"	Read-Write		
438	N69:2	41172	High to Low Speed Fan Delay (seconds)	INT		Read-Write	5	30
439	N69:3	41173	Condenser Setpoint	F-INT		Read-Write	100.0	150.0
440	N69:4	41174	Upper Deadband	F-INT		Read-Write	0.5	20.0
441	N69:5	41175	Lower Deadband	F-INT		Read-Write	0.5	20.0
442	N69:6	41176	Wetbulb Offset	F-INT		Read-Write	0.5	20.0
443	N69:7	41177	<b>Switch Temp</b>	F-INT		Read-Write	25.0	45.0
444	N69:8	41178	Summer/Winter Auto Switch Enabled	INT	0 = Disabled, 1 = Enabled	Read-Write		
445	N69:9	41179	Wetbulb Override Enabled	INT	0 = Disabled, 1 = Enabled	Read-Write		
446	N69:10	41180	Step #1 Enabled (Summer, Winter)	INT	0 = Disabled, 1 = Enabled	Read-Write		
447	N69:11	41181	Step #2 Enabled (Summer, Winter)	INT	0 = Disabled, 1 = Enabled	Read-Write		
448	N69:12	41182	Step #3 Enabled (Summer, Winter)	INT	0 = Disabled, 1 = Enabled	Read-Write		
449	N69:13	41183	Step #4 Enabled (Summer, Winter)	INT	0 = Disabled, 1 = Enabled	Read-Write		
450	N69:14	41184	Step #5 Enabled (Summer, Winter)	INT	0 = Disabled, 1 = Enabled	Read-Write		
451	N69:15	41185	Step #1 Out#1 Enabled (Summer, Winter)	INT	0 = Disabled, 1 = Enabled	Read-Write		
452	N69:16	41186	Step #2 Out#1 Enabled (Summer, Winter)	INT	0 = Disabled, 1 = Enabled	Read-Write		
453	N69:17	41187	Step #3 Out#1 Enabled (Summer, Winter)	INT	0 = Disabled, 1 = Enabled	Read-Write		
454	N69:18	41188	Step #4 Out#1 Enabled (Summer, Winter)	INT	0 = Disabled, 1 = Enabled	Read-Write		
455	N69:19	41189	Step #5 Out#1 Enabled (Summer, Winter)	INT	0 = Disabled, 1 = Enabled	Read-Write		
456	N69:20	41190	Step #1 Out#2 Enabled (Summer, Winter)	INT	0 = Disabled, 1 = Enabled	Read-Write		
457	N69:21	41191	Step #2 Out#2 Enabled (Summer, Winter)	INT	0 = Disabled, 1 = Enabled	Read-Write		
458	N69:22	41192	Step #3 Out#2 Enabled (Summer, Winter)	INT	0 = Disabled, 1 = Enabled	Read-Write		
459	N69:23	41193	Step #4 Out#2 Enabled (Summer, Winter)	INT	0 = Disabled, 1 = Enabled	Read-Write		
460	N69:24	41194	Step #5 Out#2 Enabled (Summer, Winter)	INT	0 = Disabled, 1 = Enabled	Read-Write		
461	N69:25	41195	Step #1 Out#3 Enabled (Summer, Winter)	INT	0 = Disabled, 1 = Enabled	Read-Write		
462	N69:26	41196	Step #2 Out#3 Enabled (Summer, Winter)	INT	0 = Disabled, 1 = Enabled	Read-Write		

## Appendix D • Vission 20/20 Communication Table

Vilter™ Address	Ethernet IP Address	Modbus Address	Command Name	Data Type	Value	Mode	Lower Range	Higher Range
463	N69:27	41197	Step #3 Out#3 Enabled (Summer, Winter)	INT	0 = Disabled, 1 = Enabled	Read-Write		
464	N69:28	41198	Step #4 Out#3 Enabled (Summer, Winter)	INT	0 = Disabled, 1 = Enabled	Read-Write		
465	N69:29	41199	Step #5 Out#3 Enabled (Summer, Winter)	INT	0 = Disabled, 1 = Enabled	Read-Write		
466	N69:30	41200	Step #1 Out#4 Enabled (Summer, Winter)	INT	0 = Disabled, 1 = Enabled	Read-Write		
467	N69:31	41201	Step #2 Out#4 Enabled (Summer, Winter)	INT	0 = Disabled, 1 = Enabled	Read-Write		
468	N69:32	41202	Step #3 Out#4 Enabled (Summer, Winter)	INT	0 = Disabled, 1 = Enabled	Read-Write		
469	N69:33	41203	Step #4 Out#4 Enabled (Summer, Winter)	INT	0 = Disabled, 1 = Enabled	Read-Write		
470	N69:34	41204	Step #5 Out#4 Enabled (Summer, Winter)	INT	0 = Disabled, 1 = Enabled	Read-Write		
471	N69:35	41205	Step #1 VFD Enabled (Summer, Winter)	INT	0 = Disabled, 1 = Enabled	Read-Write		
472	N69:36	41206	Step #2 VFD Enabled (Summer, Winter)	INT	0 = Disabled, 1 = Enabled	Read-Write		
473	N69:37	41207	Step #3 VFD Enabled (Summer, Winter)	INT	0 = Disabled, 1 = Enabled	Read-Write		
474	N69:38	41208	Step #4 VFD Enabled (Summer, Winter)	INT	0 = Disabled, 1 = Enabled	Read-Write		
475	N69:39	41209	Step #5 VFD Enabled (Summer, Winter)	INT	0 = Disabled, 1 = Enabled	Read-Write		
476	N69:40	41210	Step#1 Step Delay (Summer, Winter) (seconds)	INT		Read-Write	5	60
477	N69:41	41211	Step#2 Step Delay (Summer, Winter) (seconds)	INT		Read-Write	5	60
478	N69:42	41212	Step#3 Step Delay (Summer, Winter) (seconds)	INT		Read-Write	5	60
479	N69:43	41213	Step#4 Step Delay (Summer, Winter) (seconds)	INT		Read-Write	5	60
480	N69:44	41214	Step#5 Step Delay (Summer, Winter) (seconds)	INT		Read-Write	5	60
481	N69:45	41215	Step #1 Low Speed Fan (Summer, Winter)	ENUM	"0 = None 1 = Out # 1 2 = Out # 2 3 = Out # 3 4 = Out # 4"	Read		

## Appendix D • Vission 20/20 Communication Table

Vilter™ Address	Ethernet IP Address	Modbus Address	Command Name	Data Type	Value	Mode	Lower Range	Higher Range
482	N69:46	41216	Step #2 Low Speed Fan (Summer, Winter)	ENUM	"0 = None 1 = Out # 1 2 = Out # 2 3 = Out # 3 4 = Out # 4"	Read		
483	N69:47	41217	Step #3 Low Speed Fan (Summer, Winter)	ENUM	"0 = None 1 = Out # 1 2 = Out # 2 3 = Out # 3 4 = Out # 4"	Read		
484	N69:48	41218	Step #4 Low Speed Fan (Summer, Winter)	ENUM	"0 = None 1 = Out # 1 2 = Out # 2 3 = Out # 3 4 = Out # 4"	Read		
485	N69:49	41219	Step #5 Low Speed Fan (Summer, Winter)	ENUM	"0 = None 1 = Out # 1 2 = Out # 2 3 = Out # 3 4 = Out # 4"	Read		
486	N69:50	41220	Condenser VFD Gain (P)	F-INT		Read-Write	0.0	10.0
487	N69:51	41221	Condenser VFD Reset (I)	F-INT		Read-Write	0.0	10.0
488	N69:52	41222	Condenser VFD Rate (D)	F-INT		Read-Write	0.0	10.0
489	N69:53	41223	Condenser VFD Minimum Speed (%)	INT		Read-Write	0	20
490	N69:54	41224	Condenser VFD Maximum Speed (%)	INT		Read-Write	80	100
			Remote Oil Cooler					
491	N72:0	41400	Run Mode	ENUM	"0 = Run Never 1 = Run With Comp 2 = Run Always 3 = Manual"	Read-Write		
492	N72:1	41401	High to Low Speed Fan Delay (seconds)	INT		Read-Write	5	30
493	N72:2	41402	Remote Oil Cooler Temp Setpoint	F-INT		Read-Write	100.0	150.0
494	N72:3	41403	Upper Deadband	F-INT		Read-Write	0.5	20.0
495	N72:4	41404	Lower Deadband	F-INT		Read-Write	0.5	20.0
496	N72:5	41405	Step #1 Enabled	INT	0 = Disabled, 1 = Enabled	Read-Write		
497	N72:6	41406	Step #2 Enabled	INT	0 = Disabled, 1 = Enabled	Read-Write		
498	N72:7	41407	Step #3 Enabled	INT	0 = Disabled, 1 = Enabled	Read-Write		
499	N72:8	41408	Step #4 Enabled	INT	0 = Disabled, 1 = Enabled	Read-Write		



## Appendix D • Vision 20/20 Communication Table

Vilter™ Address	Ethernet IP Address	Modbus Address	Command Name	Data Type	Value	Mode	Lower Range	Higher Range
500	N72:9	41409	Step #5 Enabled	INT	0 = Disabled, 1 = Enabled	Read-Write		
501	N72:10	41410	Step #1 Out#1 Enabled	INT	0 = Disabled, 1 = Enabled	Read-Write		
502	N72:11	41411	Step #2 Out#1 Enabled	INT	0 = Disabled, 1 = Enabled	Read-Write		
503	N72:12	41412	Step #3 Out#1 Enabled	INT	0 = Disabled, 1 = Enabled	Read-Write		
504	N72:13	41413	Step #4 Out#1 Enabled	INT	0 = Disabled, 1 = Enabled	Read-Write		
505	N72:14	41414	Step #5 Out#1 Enabled	INT	0 = Disabled, 1 = Enabled	Read-Write		
506	N72:15	41415	Step #1 Out#2 Enabled	INT	0 = Disabled, 1 = Enabled	Read-Write		
507	N72:16	41416	Step #2 Out#2 Enabled	INT	0 = Disabled, 1 = Enabled	Read-Write		
508	N72:17	41417	Step #3 Out#2 Enabled	INT	0 = Disabled, 1 = Enabled	Read-Write		
509	N72:18	41418	Step #4 Out#2 Enabled	INT	0 = Disabled, 1 = Enabled	Read-Write		
510	N72:19	41419	Step #5 Out#2 Enabled	INT	0 = Disabled, 1 = Enabled	Read-Write		
511	N72:20	41420	Step #1 Out#3 Enabled	INT	0 = Disabled, 1 = Enabled	Read-Write		
512	N72:21	41421	Step #2 Out#3 Enabled	INT	0 = Disabled, 1 = Enabled	Read-Write		
513	N72:22	41422	Step #3 Out#3 Enabled	INT	0 = Disabled, 1 = Enabled	Read-Write		
514	N72:23	41423	Step #4 Out#3 Enabled	INT	0 = Disabled, 1 = Enabled	Read-Write		
515	N72:24	41424	Step #5 Out#3 Enabled	INT	0 = Disabled, 1 = Enabled	Read-Write		
516	N72:25	41425	Step #1 Out#4 Enabled	INT	0 = Disabled, 1 = Enabled	Read-Write		
517	N72:26	41426	Step #2 Out#4 Enabled	INT	0 = Disabled, 1 = Enabled	Read-Write		
518	N72:27	41427	Step #3 Out#4 Enabled	INT	0 = Disabled, 1 = Enabled	Read-Write		
519	N72:28	41428	Step #4 Out#4 Enabled	INT	0 = Disabled, 1 = Enabled	Read-Write		
520	N72:29	41429	Step #5 Out#4 Enabled	INT	0 = Disabled, 1 = Enabled	Read-Write		
521	N72:30	41430	Step #1 VFD Enabled	INT	0 = Disabled, 1 = Enabled	Read-Write		

## Appendix D • Vission 20/20 Communication Table

Vilter™ Address	Ethernet IP Address	Modbus Address	Command Name	Data Type	Value	Mode	Lower Range	Higher Range
522	N72:31	41431	Step #2 VFD Enabled	INT	0 = Disabled, 1 = Enabled	Read-Write		
523	N72:32	41432	Step #3 VFD Enabled	INT	0 = Disabled, 1 = Enabled	Read-Write		
524	N72:33	41433	Step #4 VFD Enabled	INT	0 = Disabled, 1 = Enabled	Read-Write		
525	N72:34	41434	Step #5 VFD Enabled	INT	0 = Disabled, 1 = Enabled	Read-Write		
526	N72:35	41435	Step#1 Step Delay (seconds)	INT		Read-Write	5	60
527	N72:36	41436	Step#2 Step Delay (seconds)	INT		Read-Write	5	60
528	N72:37	41437	Step#3 Step Delay (seconds)	INT		Read-Write	5	60
529	N72:38	41438	Step#4 Step Delay (seconds)	INT		Read-Write	5	60
530	N72:39	41439	Step#5 Step Delay (seconds)	INT		Read-Write	5	60
531	N72:40	41440	Step #1 Low Speed Fan	ENUM	"0 = None 1 = Out # 1 2 = Out # 2 3 = Out # 3 4 = Out # 4"	Read		
532	N72:41	41441	Step #2 Low Speed Fan	ENUM	"0 = None 1 = Out # 1 2 = Out # 2 3 = Out # 3 4 = Out # 4"	Read		
533	N72:42	41442	Step #3 Low Speed Fan	ENUM	"0 = None 1 = Out # 1 2 = Out # 2 3 = Out # 3 4 = Out # 4"	Read		
534	N72:43	41443	Step #4 Low Speed Fan	ENUM	"0 = None 1 = Out # 1 2 = Out # 2 3 = Out # 3 4 = Out # 4"	Read		
535	N72:44	41444	Step #5 Low Speed Fan	ENUM	"0 = None 1 = Out # 1 2 = Out # 2 3 = Out # 3 4 = Out # 4"	Read		
536	N72:45	41445	VFD Gain (P)	F-INT		Read-Write	0.0	10.0
537	N72:46	41446	VFD Reset (I)	F-INT		Read-Write	0.0	10.0
538	N72:47	41447	VFD Rate (D)	F-INT		Read-Write	0.0	10.0

## Appendix D • Vision 20/20 Communication Table

Vilter™ Address	Ethernet IP Address	Modbus Address	Command Name	Data Type	Value	Mode	Lower Range	Higher Range
539	N72:48	41448	VFD Minimum Speed (%)	INT		Read-Write	0	20
540	N72:49	41449	VFD Maximum Speed (%)	INT		Read-Write	80	100
			Trend Chart					
541	N73:0	41470	Motor Current Enabled	INT	0 = Disabled, 1 = Enabled	Read		
542	N73:1	41471	Suction Pressure Enabled	INT	0 = Disabled, 1 = Enabled	Read		
543	N73:2	41472	Discharge Pressure Enabled	INT	0 = Disabled, 1 = Enabled	Read		
544	N73:3	41473	Oil Filter Pressure Enabled	INT	0 = Disabled, 1 = Enabled	Read		
545	N73:4	41474	Oil Manifold Pressure Enabled	INT	0 = Disabled, 1 = Enabled	Read		
546	N73:5	41475	Economizer Pressure Enabled	INT	0 = Disabled, 1 = Enabled	Read		
547	N73:6	41476	Condenser Pressure Enabled	INT	0 = Disabled, 1 = Enabled	Read		
548	N73:7	41477	Suction Temperature Enabled	INT	0 = Disabled, 1 = Enabled	Read		
549	N73:8	41478	Discharge Temperature Enabled	INT	0 = Disabled, 1 = Enabled	Read		
550	N73:9	41479	Oil Separator Temperature Enabled	INT	0 = Disabled, 1 = Enabled	Read		
551	N73:10	41480	Oil Manifold Temperature Enabled	INT	0 = Disabled, 1 = Enabled	Read		
552	N73:11	41481	Process Control Enabled	INT	0 = Disabled, 1 = Enabled	Read		
553	N73:12	41482	Chiller Temperature Enabled	INT	0 = Disabled, 1 = Enabled	Read		
554	N73:13	41483	Suction Superheat Temperature Enabled	INT	0 = Disabled, 1 = Enabled	Read		
555	N73:14	41484	Capacity Slide Enabled	INT	0 = Disabled, 1 = Enabled	Read		
556	N73:15	41485	Volume Slide Enabled	INT	0 = Disabled, 1 = Enabled	Read		
557	N73:16	41486	Remote Capacity % Enabled	INT	0 = Disabled, 1 = Enabled	Read		
558	N73:17	41487	Auxiliary Input #1 Enabled	INT	0 = Disabled, 1 = Enabled	Read		
559	N73:18	41488	Auxiliary Input #2 Enabled	INT	0 = Disabled, 1 = Enabled	Read		

## Appendix D • Vision 20/20 Communication Table

Vilter™ Address	Ethernet IP Address	Modbus Address	Command Name	Data Type	Value	Mode	Lower Range	Higher Range
560	N73:19	41489	Auxiliary Input #3 Enabled	INT	0 = Disabled, 1 = Enabled	Read		
561	N73:20	41490	Auxiliary Input #4 Enabled	INT	0 = Disabled, 1 = Enabled	Read		
562	N73:21	41491	Auxiliary Input #5 Enabled	INT	0 = Disabled, 1 = Enabled	Read		
563	N73:22	41492	Auxiliary Input #6 Enabled	INT	0 = Disabled, 1 = Enabled	Read		
564	N73:23	41493	Auxiliary Input #7 Enabled	INT	0 = Disabled, 1 = Enabled	Read		
565	N73:24	41494	Auxiliary Input #8 Enabled	INT	0 = Disabled, 1 = Enabled	Read		
566	N73:25	41495	Auxiliary Input #9 Enabled	INT	0 = Disabled, 1 = Enabled	Read		
567	N73:26	41496	Auxiliary Input #10 Enabled	INT	0 = Disabled, 1 = Enabled	Read		
568	N73:27	41497	Auxiliary Input #11 Enabled	INT	0 = Disabled, 1 = Enabled	Read		
569	N73:28	41498	Auxiliary Input #12 Enabled	INT	0 = Disabled, 1 = Enabled	Read		
570	N73:29	41499	Auxiliary Input #13 Enabled	INT	0 = Disabled, 1 = Enabled	Read		
571	N73:30	41500	Auxiliary Input #14 Enabled	INT	0 = Disabled, 1 = Enabled	Read		
572	N73:31	41501	Auxiliary Input #15 Enabled	INT	0 = Disabled, 1 = Enabled	Read		
573	N73:32	41502	Auxiliary Input #16 Enabled	INT	0 = Disabled, 1 = Enabled	Read		
574	N73:33	41503	Compressor VFD Enabled	INT	0 = Disabled, 1 = Enabled	Read		
575	N73:34	41504	Condenser VFD Enabled	INT	0 = Disabled, 1 = Enabled	Read		
576	N73:35	41505	Slide Valve Position Enabled	INT	0 = Disabled, 1 = Enabled	Read		
577	N73:36	41506	Liquid Injection Enabled	INT	0 = Disabled, 1 = Enabled	Read		
578	N73:37	41507	Auxiliary Output #1 Enabled	INT	0 = Disabled, 1 = Enabled	Read		
579	N73:38	41508	Auxiliary Output #2 Enabled	INT	0 = Disabled, 1 = Enabled	Read		
580	N73:39	41509	Auxiliary Output #3 Enabled	INT	0 = Disabled, 1 = Enabled	Read		
581	N73:40	41510	Auxiliary Output #4 Enabled	INT	0 = Disabled, 1 = Enabled	Read		

## Appendix D • Vission 20/20 Communication Table

Vilter™ Address	Ethernet IP Address	Modbus Address	Command Name	Data Type	Value	Mode	Lower Range	Higher Range
582	N73:41	41511	Trend Files Location	ENUM	"0 = Hard Disk 1 = USB Drive"	Read		
			Configuration (Time)					
583	N76:0	41330	Time – Hours	INT	(HH)	Read-Write	0	23
584	N76:1	41331	Time – Min	INT	(MM)	Read-Write	0	59
585	N76:2	41332	Time – Secs	INT	(SS)	Read-Write	0	59
586	N76:3	41333	Date – Year	INT	(YYYY)	Read-Write	1970	2037
587	N76:4	41334	Date – Month	INT	(1-12)	Read-Write	1	12
588	N76:5	41335	Date – Day	INT	(1-31)	Read-Write	1	31
			Configuration (Other)					
589	N77:0	41340	Anti-Recycle	ENUM	"0 = True Anti-Recycle 1 = Accumulative Anti-Recycle 2 = Hot Starts"	Read		
590	N77:1	41341	Restart On Power Fail	ENUM	"0 = Always 1 = Never 2 = Timed 3 = Remote Lock Off 4 = Boot in Remote (Direct I/O)"	Read-Write		
591	N77:2	41342	Suction Pressure Control Available	INT	0 = No, 1 = Yes	Read		
592	N77:3	41343	Suction Pressure Control # of Setpoints	INT		Read		
593	N77:4	41344	Process Control Available	INT	0 = No, 1 = Yes	Read		
594	N77:5	41345	Process Control # of Setpoints	INT		Read		
595	N77:6	41346	% Slide Volume Position	INT	0 = No, 1 = Yes	Read		
596	N77:7	41347	Economizer Pressure	INT	0 = No, 1 = Yes	Read		
597	N77:8	41348	Compressor VFD	INT	0 = No, 1 = Yes	Read		
598	N77:9	41349	Compressor Sequencing	INT	0 = No, 1 = Yes	Read		
599	N77:10	41350	Superheat Monitor	INT	0 = No, 1 = Yes	Read		
600	N77:11	41351	Oil Pump Control Type	ENUM	"0 = No Pump 1 = Stal 2 = Cycling 3 = Full Time 4 = Cool Compression 5 = Suction Oil Injection Solenoid"	Read		

## Appendix D • Vision 20/20 Communication Table

Vilter™ Address	Ethernet IP Address	Modbus Address	Command Name	Data Type	Value	Mode	Lower Range	Higher Range
601	N77:12	41352	# Oil Pumps	INT	(Currently Unused)	Read		
602	N77:13	41353	Condenser Control	INT	0 = No, 1 = Yes	Read		
603	N77:14	41354	Ambient Sensor	INT	0 = No, 1 = Yes	Read		
604	N77:15	41355	Wetbulb Sensor	INT	0 = No, 1 = Yes	Read		
605	N77:16	41356	Condenser VFD	INT	0 = No, 1 = Yes	Read		
606	N77:17	41357	Oil Cooling Type	ENUM	"0 = Thermosyphon 1 = H2O Oil Cooler 2 = Liquid Injection 3 = Cool Compression 4 = Remote Oil Cooler"	Read		
607	N77:18	41358	Liquid Injection Type	ENUM	"0 = Solenoids 1 = Motorized Valve"	Read		
608	N77:19	41359	# Liquid Injection Solenoids	INT	(Currently Unused)	Read		
609	N77:20	41360	Discharge Pressure Control Available	INT	0 = No, 1 = Yes	Read		
610	N77:21	41361	Discharge Pressure Control # of Setpoints	INT		Read		
611	N77:22	41362	On Communication Failure	ENUM	"0 = Revert to Local Control 1 = Stop with Alarm"	Read		
612	N77:23	41363	Suction Superheat Monitor	INT	0 = No, 1 = Yes	Read		
613	N77:24	41364	Oil Flow Control	INT	0 = No, 1 = Yes	Read		
614	N77:25	41365	Remote Oil Cooler VFD	INT	0 = No, 1 = Yes	Read		
615	N77:26	41366	Rapid Cycling VFD	INT	0 = No, 1 = Yes	Read		
616	N77:27	41367	Panel ID	INT		Read		
617	N77:28	41368	Process Control Type	ENUM	"0 = Temperature 1 = Pressure"	Read		
618	N77:29	41369	Motor Current Device	ENUM	"0 = Current Transformer 1 = 4-20ma Transmitter"	Read		
619	N77:30	41370	Idle Time Trip		0 = No, 1 = Yes	Read		
620	N77:31	41371	Oil Restriction Solenoid		0 = No, 1 = Yes	Read		
621	N77:32	41372	Database Backup Hours	INT	(HH)	Read		
622	N77:33	41373	Database Backup Minute	INT	(MM)	Read		

## Appendix D • Vission 20/20 Communication Table

### NOTES

- Analog Outputs: spare1 / spare2 / spare3 – send a floating point value between 4.0 and 20.0 to drive a 4-20 mA signal output (assumes proper calibration)
- Statuses: Alarm Status Word(s) – currently 20 alarms, so both Alarm Status Word 1 and 2 are used, with each position indicating an alarm:

MSB	LSB
[Bit 15, Bit 14, Bit 13, ... Bit 3, Bit 2, Bit 1, Bit 0]	

Word 1	Word 2
Bit 0 = Low Oil Pressure Alarm	Bit 0 = High Oil Separator Temp. Alarm
Bit 1 = Add Oil to the middle sight glass	Bit 1 = Low Suction Superheat Temp Alarm
Bit 2 = Low Oil Injection Temp. Alarm	Bit 2 = Low Process Pressure Alarm
Bit 3 = High Filter Differential Alarm	Bit 3 = High Process Pressure Alarm
Bit 4 = Low Suction Temp. Alarm	Bit 4 = Unused
Bit 5 = High Discharge Temp. Alarm	Bit 5 = Unused
Bit 6 = Low Suction Pressure Alarm	Bit 6 = Unused
Bit 7 = High Discharge Pressure Alarm	Bit 7 = Unused
Bit 8 = High Process Temp. Alarm	Bit 8 = Unused
Bit 9 = Low Process Temp. Alarm	Bit 9 = Unused
Bit 10 = Low Oil Separator Temp. Alarm	Bit 10 = Unused
Bit 11 = High Oil Injection Temp. Alarm	Bit 11 = Unused
Bit 12 = High Motor Current Alarm	Bit 12 = Unused
Bit 13 = Remote Comm Time-out	Bit 13 = Unused
Bit 14 = High Superheat Run Temp. Alarm	Bit 14 = Unused
Bit 15 = Low Run Pressure Ratio Alarm	Bit 15 = Unused

## Appendix D • Vission 20/20 Communication Table

- Statuses: Trip Status Word(s) – currently 54 trips, so all Trip Status Words 1, 2, 3 and 4 are used, with each position indicating an trip:

MSB	LSB
[Bit 15, Bit 14, Bit 13, ... Bit 3, Bit 2, Bit 1, Bit 0]	

Word 1	Word 2
Bit 0 = Low Suction Pressure Warning	Bit 0 = High Process Pressure Warning
Bit 1 = High Discharge Pressure Warning	Bit 1 = Unused
Bit 2 = Low Process Temp. Warning	Bit 2 = Unused
Bit 3 = Low Suction Temp. Warning	Bit 3 = Unused
Bit 4 = High Discharge Temp. Warning	Bit 4 = Unused
Bit 5 = Low Oil Separator Temp. Warning	Bit 5 = Unused
Bit 6 = High Oil Injection Temp. Warning	Bit 6 = Unused
Bit 7 = High Superheat Temp Warning	Bit 7 = Unused
Bit 8 = High Filter Differential Warning	Bit 8 = Unused
Bit 9 = High Level Shutdown Warning	Bit 9 = Unused
Bit 10 = Low Discharge Pressure Warning	Bit 10 = Unused
Bit 11 = Low Discharge Temp. Warning	Bit 11 = Unused
Bit 12 = Low Oil Injection Temp. Warning	Bit 12 = Unused
Bit 13 = Low Oil Filter In Pressure Warning	Bit 13 = Unused
Bit 14 = Low Oil Filter Out Pressure Warning	Bit 14 = Unused
Bit 15 = Low Process Pressure Warning	Bit 15 = Unused



## Appendix D • Vission 20/20 Communication Table

- Statuses: Trip Status Word(s) – currently 54 trips, so all Trip Status Words 1, 2, 3 and 4 are used, with each position indicating an trip:

MSB	LSB
[Bit 15, Bit 14, Bit 13, ... Bit 3, Bit 2, Bit 1, Bit 0]	

Word 1	Word 2	Word 3	Word 4
Bit 0 = High Level Shutdown Inhibit	Bit 0 = High Discharge Temp. Trip	Bit 0 = High Filter Differential Inhibit	Bit 0 = Low Process Pressure Inhibit
Bit 1 = Low Process Temp. Inhibit	Bit 1 = Low Suction Pressure Trip	Bit 1 = High Superheat Temp. Inhibit	Bit 1 = High Process Pressure Inhibit
Bit 2 = High Discharge Pressure Inhibit	Bit 2 = High Discharge Pressure Trip	Bit 2 = High Superheat Start Temp. Trip	Bit 2 = Low Process Pressure Trip
Bit 3 = High Discharge Temp. Inhibit	Bit 3 = Starter Shutdown Trip	Bit 3 = High Superheat Rise Temp. Trip	Bit 3 = High Process Pressure Trip
Bit 4 = Low Oil Separator Start Temp. Inhibit	Bit 4 = Low Process Temp. Trip	Bit 4 = High Superheat Run Temp. Trip	Bit 4 = Start Low Oil Pressure Trip
Bit 5 = Low Suction Pressure Inhibit	Bit 5 = Low Oil Separator Temp. Trip	Bit 5 = Low Run Pressure Ratio Trip	Bit 5 = Oil Over Pressure Trip
Bit 6 = Low Suction Temp. Inhibit	Bit 6 = High Oil Injection Temp. Trip	Bit 6 = High Oil Separator Temp. Trip	Bit 6 = Oil Over Pressure Inhibit
Bit 7 = High Oil Injection Temp. Inhibit	Bit 7 = High Motor Current Trip	Bit 7 = Prelube Oil Pressure Trip	Bit 7 = Unused
Bit 8 = Prelube Oil Pump Inhibit	Bit 8 = Capacity Position Trip	Bit 8 = Low Suction Superheat Temp Trip	Bit 8 = Unused
Bit 9 = Compressor Interlock Inhibit	Bit 9 = Volume Position Trip	Bit 9 = Remote Comm Time-out	Bit 9 = Unused
Bit 10 = High Level Shutdown Trip	Bit 10 = False Start	Bit 10 = Low Discharge Pressure Inhibit	Bit 10 = Unused
Bit 11 = Compressor Interlock Trip	Bit 11 = Emergency Shutdown Activated	Bit 11 = Low Discharge Temp. Inhibit	Bit 11 = Unused
Bit 12 = Low Oil Pressure Trip	Bit 12 = Oil Level #1 Inhibit Trip	Bit 12 = Low Discharge Pressure Trip	Bit 12 = Unused
Bit 13 = Low Oil Injection Temp. Trip	Bit 13 = Oil Level #1 Trip	Bit 13 = Low Discharge Temp. Trip	Bit 13 = Unused
Bit 14 = High Filter Differential Trip	Bit 14 = Oil Level #2 Trip	Bit 14 = Low Oil Filter In Pressure Trip	Bit 14 = Unused
Bit 15 = Low Suction Temp. Trip	Bit 15 = Low Oil Level Trip After Stop	Bit 15 = Low Oil Filter Out Pressure Trip	Bit 15 = Unused

## Appendix D • Vission 20/20 Communication Table

---

- Commands: Start Command – starts the compressor in the currently active control mode / auto sequencing. When this command is read, 1 is returned if compressor is in starting mode or waiting mode
- Compressor Scheduling: Enable/Disable – if a valid schedule has not been defined (on screen or through comm), this command will fail.
- Compressor Scheduling: Control Mode ENUM – 0 = Unscheduled

When enabling the schedule, allow for a timeout of at least 3 seconds for the schedule to be verified as valid.

1 = Suction Pressure SP1

2 = Suction Pressure SP2

3 = Process Temp. SP1

4 = Process Temp. SP2

5 = Discharge Pressure SP1

6 = Discharge Pressure SP2

Note: If the control mode being set isn't active in the configuration, the command will result in error. This value is allowed to be changed only when the schedule is enabled

Compressor Scheduling: Hour INT – This value is allowed to be changed only when the schedule is disabled

Compressor Scheduling: Minute INT – This value is allowed to be changed only when the schedule is disabled

## Appendix E • Abbreviations Used on the Vission 20/20™ Panel Screen

### Abbreviations Used on the Vission 20/20™ Panel Screen

As a result of the space limitations on the screen of the Vission 20/20™ panel, at times it's necessary to use abbreviations to refer to parameters, variables, etc. This table details the meaning of the abbreviations used on screen.

Table E. Abbreviations used

Abbreviation	Meaning
Max	Maximum
Min	Minimum
Admin	Administrator
Press	Pressure
Temp	Temperature
Diff	Differential
Inj	Injection
Sep	Separator
Disch.	Discharge
Aux	Auxiliary
In	Input
Out	Output
Auto	Automatic
Seq	Sequence
Vol	Volume
Cap	Capacity
Avg	Average
SP	Setpoint
VFD	Variable Frequency Drive
VI	Volume Index
CFM	Cubic Feet per minute
Sync	Synchronize
DI	Digital Input
I/O	Input/Output
SOI	Solenoid Oil Injection
N.O.	Normally Open
N.C.	Normally Closed
VNC	Virtual Network Computing
Pos.	Position
RTD	Resistance Temperature Detector
P	Proportional
I	Integral
D	Derivative





