

Data sheet

Liquid Level Sensor

Type AKS 4100/4100U

AKS 4100/4100U - Cable Version



AKS 4100/4100U - Coaxial Version



The AKS 4100/4100U liquid level sensor is designed specifically to measure liquid levels in a wide range of refrigeration applications.

The AKS 4100/4100U liquid level sensor is based on a proven technology called Time Domain Reflectometry (TDR) or Guided Micro Wave.

AKS 4100/4100U liquid level sensor can be used to measure the liquid level of many different refrigerants in vessels, accumulators, receivers, standpipes, etc.

The electrical output is a 2-wired, loop powered 4 – 20 mA output signal, which is proportional to the refrigerant liquid level.

AKS 4100/4100U in a cable version is suitable for HCFC, Non flammable HFC and R717 (Ammonia), and differing lengths from 800 mm / 31.5 in. and up to 5000 mm / 197 in..

The coaxial version of AKS 4100/4100U is designed for use with R744 (CO₂), HCFC, Non flammable HFC and R717 (Ammonia).

The AKS 4100/4100U coaxial version should always be used for marine applications for all refrigerant types.

The AKS 4100/4100U cable version should NOT be used for CO₂ or marine applications.

Dust, foam, vapour, agitated surfaces, boiling surfaces, changes in density or in the dielectric constant, ϵ_r , for the liquid have no influence on the AKS 4100/4100U performance.

Oil accumulated in the bottom of a standpipe will not disturb the liquid level signal and it is not necessary to remove AKS 4100/4100U for cleaning after oil has been drained out of the standpipe.

Features

- Approved and qualified by Danfoss for refrigeration applications
 - One product covering several probe lengths (cable version)
 - A single product for all commonly used refrigerants (cable version)
 - Cable version requires less top-end clearance for installation and service
 - Proven operation with all refrigerants in combination with oil.
 - No need to clean cable version when fully covered by oil.
 - The cable version is very compact and easy to handle, ship, install and use with different lengths and refrigerants
 - Changes of the liquid dielectric constant (ϵ_r) do not affect operation.
 - 5000 mm / 197 in. probe length with cable version
 - 2-wire loop powered; no separate transformer needed.
- Please Note:**
AKS 4100/4100U can be connected directly to Danfoss EKE 347 liquid level controller and thus be powered from EKE 347.
- If used together with Danfoss EKC 347 liquid level controller, a 14 – 30 V DC supply is required.
- Multi language HMI. Level and setting readout in mm,cm,m (ft, in.)
- Language HMI versions:
- English (default), German, French, Spanish
- English (default), Japanese, Chinese Russian

For further details regarding mechanical and electrical installation please refer to the product installation guides DKRCI.PI.SC0.D (CABLE version), DKRCI.PI.SC0.E (COAXIAL D14 version) and DKRCI.PI.SC0.H1/DKRCI.PI.SC0.J1 (COAXIAL D22 version).

Contents	Page
Features	1
Product concept	3
CABLE version	3
COAXIAL D14 version	3
COAXIAL D22 version	3
Optional HMI	5
Measuring principle	6
Main technical data	6
Measuring range of AKS 4100/4100U:	
CABLE version	7
COAXIAL D14 version	8
COAXIAL D22 version	8
Ordering AKS 4100/4100U	9
Dimensions and weights	10
Technical data	11
Quick setup:	
CABLE version	13
COAXIAL version	14
Forcing mA output	16
Entering refrigerant dielectric gas constant	16
Saturated vapour dielectric constant	17
How to change the language setting (Default: English)	18
Reset to factory setting	18

Product concept

AKS 4100/4100U is available in two different versions:

- Cable version
- Coaxial version

Both Cable and Coaxial versions are available with two different mechanical process connections:

- AKS 4100: G1 in. pipe thread.
Aluminium gasket included
- AKS 4100U: 3/4 in. NPT

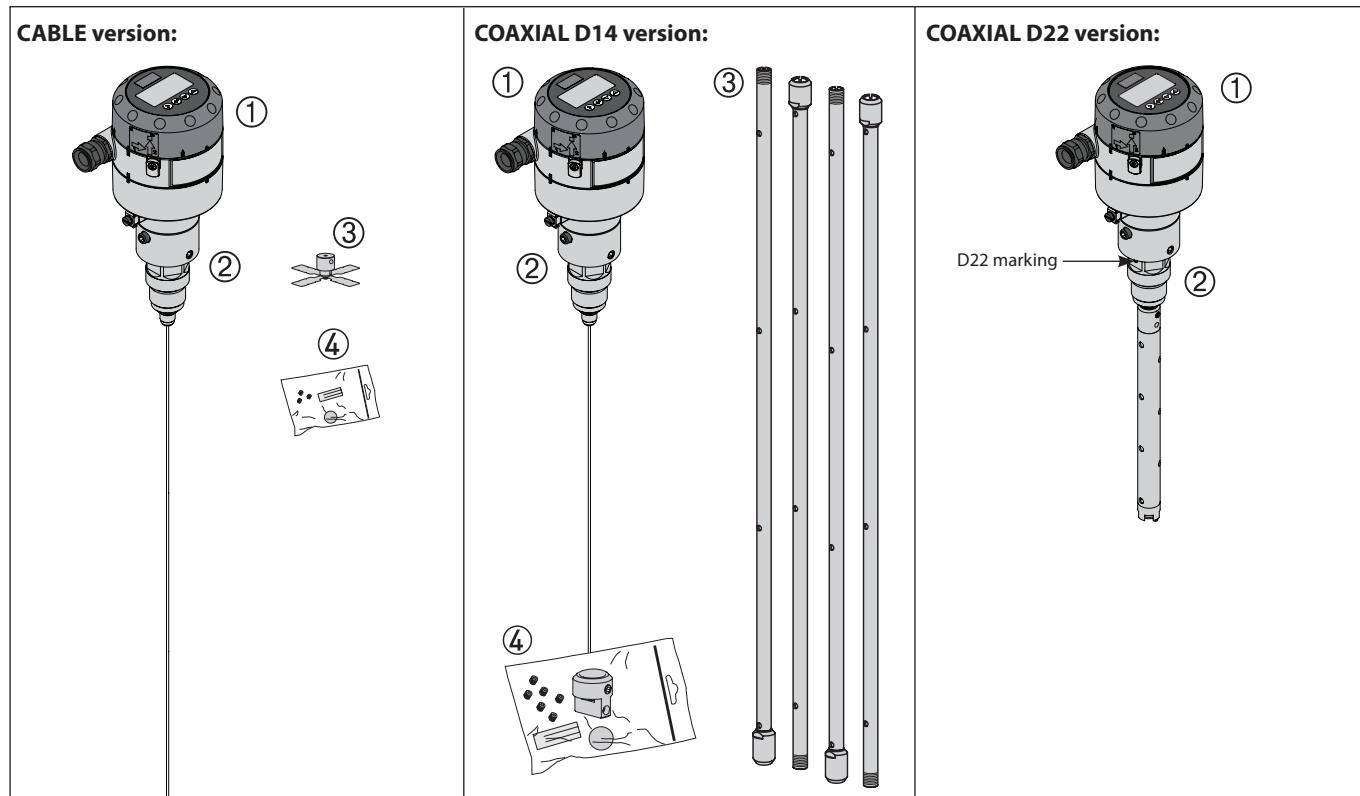

Cable version

Cable version

The cable version consists of:

- ① Signal converter, which can be supplied with or without HMI
- ② Mechanical process connection with 5 m / 197 in., Ø2 mm / 0.08 in. stainless cable
- ③ Counterweight
- ④ Accessory bag comprising:
3 mm set screws
Red cover to protect mechanical process connection ② prior to mounting signal converter.
Setting label.

With the cable version it is possible to adapt the AKS 4100/4100U to any possible length in the range of 800 mm / 31.5 in. to 5000 mm / 196.9 in.

Cable version can be used in R717 / NH₃, HCFC and HFC (ε_r liquid > 5.6).

AKS 4100/4100U cable version must ALWAYS be installed in a standpipe.

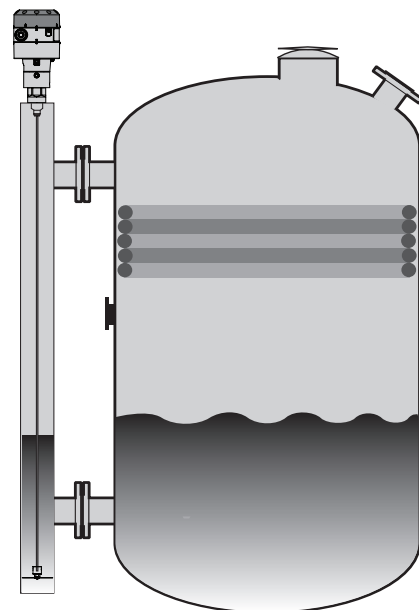

Coaxial version

Coaxial D14 version (see page 3)

The Coaxial D14 version consists of:

- ① Signal Converter (with or without HMI)
- ② Mechanical process connection with 5 m / 197 in., Ø2 mm / 0.08 stainless wire
- ③ Tube(s) depending on required length
- ④ Accessory bag comprising:
 - End Connector (incl. 3 mm / 0.12 in. set screws.)
 - 3 mm / 0.12 in. set crews (1 set screw pr. tube)
 - Red cover to protect mechanical process connection ②, before Signal Converter is mounted.
 - Setting label.

Coaxial D22 version (see page 3)

The Coaxial D22 version consists of:

- ① Signal Converter (with or without HMI)
- ② Mechanical process connection 280 mm / 11 in., .8 mm / 0.3 in. inner rod.

The coaxial version is mandatory for use in:

- R744 / CO₂ (εr, liquid > 1.3).
- Marine applications

The coaxial version can also be used in the refrigerants:

R717 / NH₃, HCFC and HFC.

The coaxial version is available in the following probe lengths:

Danfoss type	Tube diameter		Type selection in HMI	Thread
AKS 4100, 280 mm	22 mm	0.87 in.	D22	G1 in. pipe thread
AKS 4100, 500 mm	14 mm	0.55 in.	D14	G1 in. pipe thread
AKS 4100, 800 mm	14 mm	0.55 in.	D14	G1 in. pipe thread
AKS 4100, 1000 mm	14 mm	0.55 in.	D14	G1 in. pipe thread
AKS 4100, 1200 mm	14 mm	0.55 in.	D14	G1 in. pipe thread
AKS 4100, 1500 mm	14 mm	0.55 in.	D14	G1 in. pipe thread
AKS 4100, 1700 mm	14 mm	0.55 in.	D14	G1 in. pipe thread
AKS 4100, 2200 mm	14 mm	0.55 in.	D14	G1 in. pipe thread
AKS 4100U, 11.0 in.	22 mm	0.87 in.	D22	¾ in. NPT
AKS 4100U, 19.2 in.	14 mm	0.55 in.	D14	¾ in. NPT
AKS 4100U, 30 in.	14 mm	0.55 in.	D14	¾ in. NPT
AKS 4100U, 45 in.	14 mm	0.55 in.	D14	¾ in. NPT
AKS 4100U, 55 in.	14 mm	0.55 in.	D14	¾ in. NPT
AKS 4100U, 65 in.	14 mm	0.55 in.	D14	¾ in. NPT
AKS 4100U, 85 in.	14 mm	0.55 in.	D14	¾ in. NPT

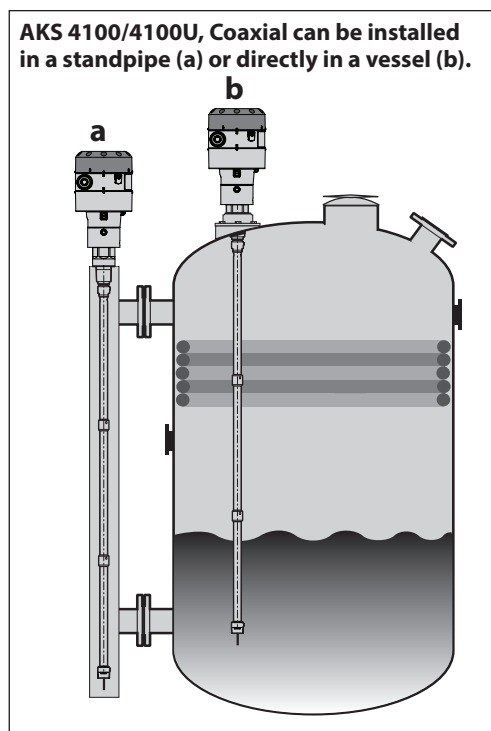

Optional HMI

The optional HMI Service/Display unit is used for commissioning and quick on-site setup and is easily mounted on the AKS 4100/4100U.

Supported standard languages: English (default), German, French, Spanish, Japanese, Chinese and Russian.

The service unit supports multiple languages in both SI and US units.

The diagram shows a circular HMI display with a red Danfoss logo at the top. The display screen shows 'AKS 4100' at the top, a measurement reading of '0 mm', and a bar graph below it. A 'DISTANCE' label is on the left, and a flashing star is on the right. Below the display are four keypad buttons: a right arrow, a left arrow, a down arrow, and an up arrow. Arrows point from these buttons to descriptive text blocks. A legend on the right lists seven numbered items corresponding to the display elements.

- ① 4 – 20 mA output displayed as bar graph and in percentage [%]
- ② Measurement name (in this example, DISTANCE)
- ③ Device tag name
- ④ Measurement reading and unit
- ⑤ Device status (markers)
Marker 1, 2 and 3 (Error)
Hardware problem; the Signal Converter hardware is defective. Contact Danfoss.
Marker 4 and 5 (Notification)
Depending on the level, the marker is ON or OFF. Used for Danfoss service information only.
- ⑥ Keypad buttons
- ⑦ Flashing star indicating unit in operation.

**Enter menu system
Enter QUICK SETUP**

Unit change at distance/level readout:
m, cm, mm, in, ft

Change between:
Distance*
Level**
Output (%)***
Output (mA)****

* DISTANCE is a display option.
If the display is set to "DISTANCE" the displayed value will be the distance from the Reference point to the top surface of the liquid refrigerant (see pages 7 and 8).

** LEVEL is display option.
If the display is set to "LEVEL" then the value displayed will be:
PROBE LENGTH (entered in QUICK SETUP)
– DISTANCE (see pages 7 and 8)

***OUTPUT (%) is display option.
Will represent the level of refrigerant, in percent, scaled (entered in QUICK SETUP) according to: SCALE 4 mA (0%), SCALE 20 mA (100%) (see pages 7 and 8).

**** OUTPUT I (mA) is display option.
Will represent the level of refrigerant, in 4 – 20 milliamperes, scaled (entered in QUICK SETUP) according to: SCALE 4 mA (4 mA), SCALE 20 mA (20 mA) (see pages 7 and 8).

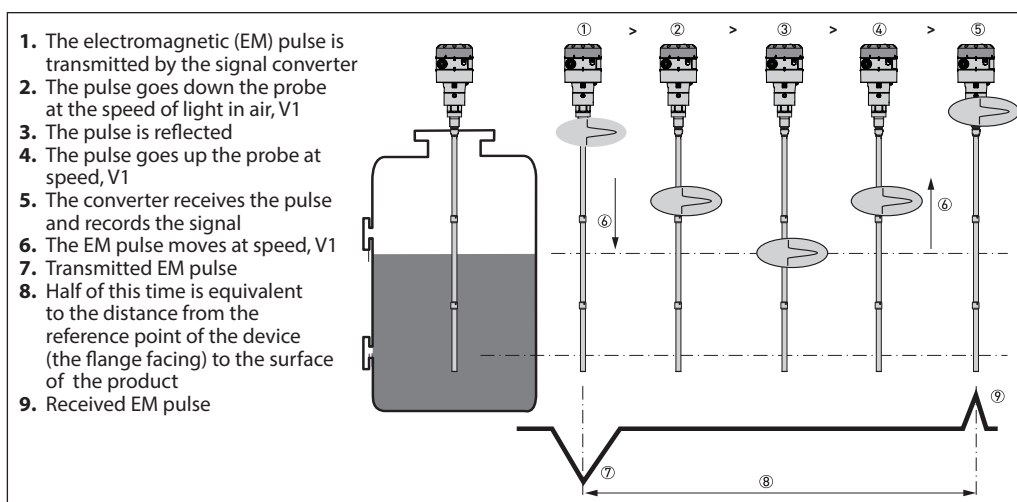
**Measuring principle
(Cable and Coaxial)**

1. The electromagnetic (EM) pulse is transmitted by the signal converter
2. The pulse goes down the probe at the speed of light in air, V_1
3. The pulse is reflected
4. The pulse goes up the probe at speed, V_1
5. The converter receives the pulse and records the signal
6. The EM pulse moves at speed, V_1
7. Transmitted EM pulse
8. Half of this time is equivalent to the distance from the reference point of the device (the flange facing) to the surface of the product
9. Received EM pulse

The AKS 4100/4100U electronic converter emits low-intensity, high frequency electromagnetic pulses with a width of approximately 1 nanosecond, which travel at the speed of light along the probe (wire or coaxial cable) down to the liquid surface.

The pulses are reflected by the liquid surface, guided back along the probe, and received and analysed by the AKS 4100/4100U electronic converter and then converted into a liquid level reading. This method is called time domain reflectometry (TDR) or guided microwave.

The dielectric constant, ϵ_r , of the liquid is a key parameter and has a direct impact on the degree of reflection of the high frequency electromagnetic pulses. Liquids with high ϵ_r values, such as ammonia, produce strong reflections, while liquids with low ϵ_r values, such as CO_2 , produce weak reflections.

As long as the ϵ_r value of the liquid refrigerant is higher than 1.2, AKS 4100/4100U can detect the liquid level and level measurement accuracy is not affected.

If the temperature condition in the standpipe / vessel is known, a constant (dielectric constant of the refrigerant gas) can be entered (parameter 2.5.3 GAS EPS.R), in order to obtain improved Top and Bottom Dead Zone values.

Refer to pages 7 to 8 for Measuring range of AKS 4100/4100U - CABLE version and COAXIAL version.

For details of gas constant values for different temperatures and refrigerants plus the procedure for entering these via the HMI, refer to pages 16 to 17.

Main technical data
(see a complete list of all technical data on page 11)
Supply Voltage

14 – 30 V DC. Min/Max. Value for an output of 22 mA at the terminal.

Ambient temperature supply voltage limitations:

-40 – 80 °C / -40 – 176 °F : 16 – 30 V DC
 -20 – 80 °C / -4 – 176 °F : 14 – 30 V DC

Load

RL [Ω] ≤ ((Uext - 14 V) / 20 mA).
 – Default (Error output set to 3.6 mA)
 RL [Ω] ≤ ((Uext - 14 V) / 22 mA).
 – (Error output set to 22 mA)

Cable gland

AKS 4100 PG 13, M20×1.5 ;
 (cable diameter: 6 – 8 mm / 0.24 – 0.31 in.
 AKS 4100U ½ in. NPT

Refrigerant temperature
 -60 – 100 °C / -76 – 212 °F

Ambient temperature
 -40 – 80 °C / -40 – 176 °F
 For HMI : -20 – 60 °C / -4 – 140 °F

Process pressure
 -1 – 100 barg / -14.5 – 1450 psig

Terminals (spring loaded)
 0.5 – 1.5 mm² (~20-15 AWG)

Enclosure:
 IP 66/67 (~NEMA type 4X)

Mechanical connection
Cable version / Coaxial version:

AKS 4100: G1 in. pipe thread.
 Aluminium gasket included
 AKS 4100U: ¾ in. NPT

Refrigerants¹⁾

The listed refrigerants are qualified and approved by Danfoss

R717 / NH₃ -40 – 50 °C / -40 – 122 °F
 R744 / CO₂ -50 – 15 °C / -58 – 59 °F

HCFC: R22 -50 – 48 °C / -58 – 118 °F
 HFC: R404A -50 – 15 °C / -58 – 59 °F
 R410A -50 – 15 °C / -58 – 59 °F
 R134A -40 – 50 °C / -40 – 122 °F

The listed refrigerants may be used in the complete temperature range of AKS 4100/4100U, however, the accuracy may be affected if the above listed temperature range is exceeded.

Other refrigerants within the groups of HCFC and HFC can be detected and measured if the following conditions are fulfilled:

Reference conditions

Dielectric constant
 Cable version can be used in R717 / NH₃, HCFC and HFC (ϵ_r , liquid > 5.6).

The coaxial version is mandatory for use in:
 - R744 / CO₂ (ϵ_r , liquid > 1.3).
 - Marine applications.

The coaxial version can also be used in the refrigerants:
 R717 / NH₃, HCFC and HFC.

¹⁾ AKS 4100 Coaxial 280mm and AKS 4100U Coaxial 11 in are only released for R717/NH₃

Measuring range of AKS 4100/4100U - CABLE version

Bottom deadzone values based on the factory setting of dielectric constant

Refrigerant	Probe length range		Bottom dead zone	
	[mm]	[in.]	[mm]	[in.]
Ammonia, HFC, HCFC	800	31.5	115	4.2
	801 – 999	31.5 – 39	120	4.7
	1000 – 1999	39 – 79	150	5.9
	2000 – 2999	79 – 118	180	7.1
	3000 – 3999	118 – 157	210	8.3
	4000 – 5000	157 – 197	240	9.4

Improved Bottom dead zone values after the adjustment of dielectric constant

Refrigerant	Probe length range		Bottom dead zone	
	[mm]	[in.]	[mm]	[in.]
Ammonia, HFC, HCFC	800 – 5000	31.5 – 197	90	3.5

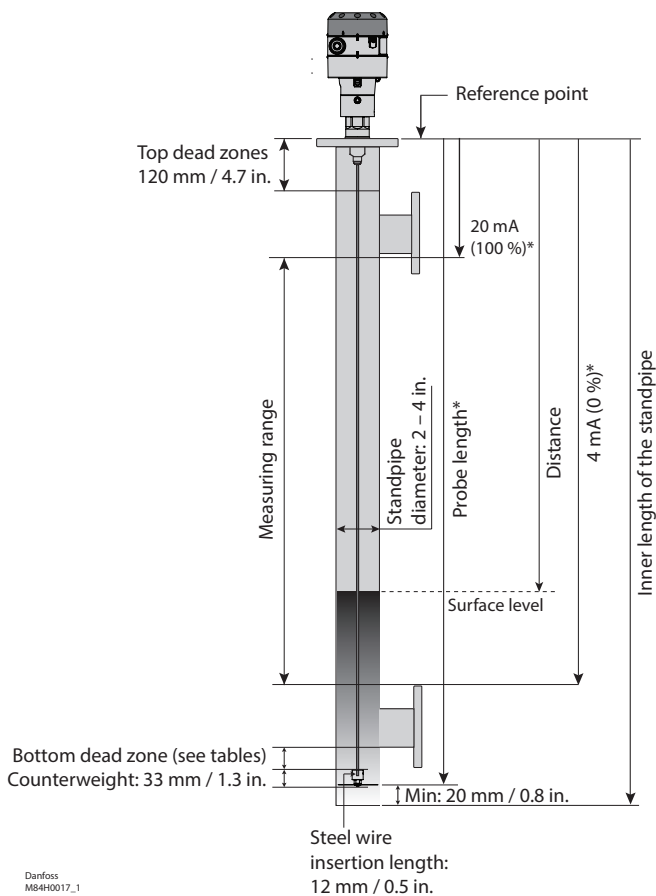
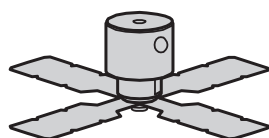

* Values to be entered into HMI Quick Setup menu and recorded on the setting label. Stick the setting label onto the Signal Converter either inside or outside.

Danfoss M84H0017_1

Measuring range of AKS 4100/4100U - COAXIAL D14 version

Please note: It is mandatory to input dielectric constant for CO₂ applications.

AKS 4100

Dielectric Constant ϵ_r always set during Quick Setup

Refrigerant	Probe Length		Bottom Dead Zone [mm]	Bottom Dead Zone [in.]
	[mm]	[in.]		
CO ₂	500	19.7	170	6.7
	800	31.5		
	1000	39.4		
	1200	47.2		
	1500	59.1		
	1700	66.9		
2200	86.6			

Factory setting

Refrigerant	Probe Length		Bottom Dead Zone [mm]	Bottom Dead Zone [in.]
	[mm]	[in.]		
Ammonia	500	19.7	95	3.7
	800	31.5	104	4.1
	1000	39.4	110	4.3
	1200	47.2	116	4.6
	1500	59.1	125	4.9
	1700	66.9	131	5.2
2200	86.6	146	5.8	

Improved Bottom dead zone values after the adjustment of dielectric constant

Refrigerant	Probe Length		Bottom Dead Zone [mm]	Bottom Dead Zone [in.]
	[mm]	[in.]		
Ammonia	500	19.7	80	3.2
	800	31.5		
	1000	39.4		
	1200	47.2		
	1500	59.1		
	1700	66.9		
2200	86.6			

Factory setting

Refrigerant	Probe Length		Bottom Dead Zone [mm]	Bottom Dead Zone [in.]
	[mm]	[in.]		
HCFC,HFC	500	19.7	115	4.5
	800	31.5	124	4.9
	1000	39.4	130	5.1
	1200	47.2	136	5.4
	1500	59.1	145	5.7
	1700	66.9	151	5.9
2200	86.6	166	6.5	

Improved Bottom dead zone values after the adjustment of dielectric constant

Refrigerant	Probe Length		Bottom Dead Zone [mm]	Bottom Dead Zone [in.]
	[mm]	[in.]		
HCFC,HFC	500	19.7	100	3.9
	800	31.5		
	1000	39.4		
	1200	47.2		
	1500	59.1		
	1700	66.9		
2200	86.6			

AKS 4100U

Dielectric Constant ϵ_r always set during Quick Setup

Refrigerant	Probe Length		Bottom Dead Zone [in.]	Bottom Dead Zone [mm]
	[in.]	[mm]		
CO ₂	19.2	170	6.7	170
	30			
	45			
	55			
	65			
	85			

Factory setting

Refrigerant	Probe Length		Bottom Dead Zone [in.]	Bottom Dead Zone [mm]
	[in.]	[mm]		
Ammonia	19.2	3.73	95	103
	30	4.05	103	114
	45	4.50	114	122
	55	4.80	122	130
	65	5.10	130	145
	85	5.70	145	

Improved Bottom dead zone values after the adjustment of dielectric constant

Refrigerant	Probe Length		Bottom Dead Zone [in.]	Bottom Dead Zone [mm]
	[in.]	[mm]		
Ammonia	19.2	80	3.1	80
	30			
	45			
	55			
	65			
	85			

Factory setting

Refrigerant	Probe Length		Bottom Dead Zone [in.]	Bottom Dead Zone [mm]
	[in.]	[mm]		
HCFC,HFC	19.2	4.52	115	123
	30	4.84	123	134
	45	5.29	134	142
	55	5.59	142	150
	65	5.89	150	165
	85	6.49	165	

Improved Bottom dead zone values after the adjustment of dielectric constant

Refrigerant	Probe Length		Bottom Dead Zone [in.]	Bottom Dead Zone [mm]
	[in.]	[mm]		
HCFC,HFC	19.2	100	3.94	100
	30			
	45			
	55			
	65			
	85			

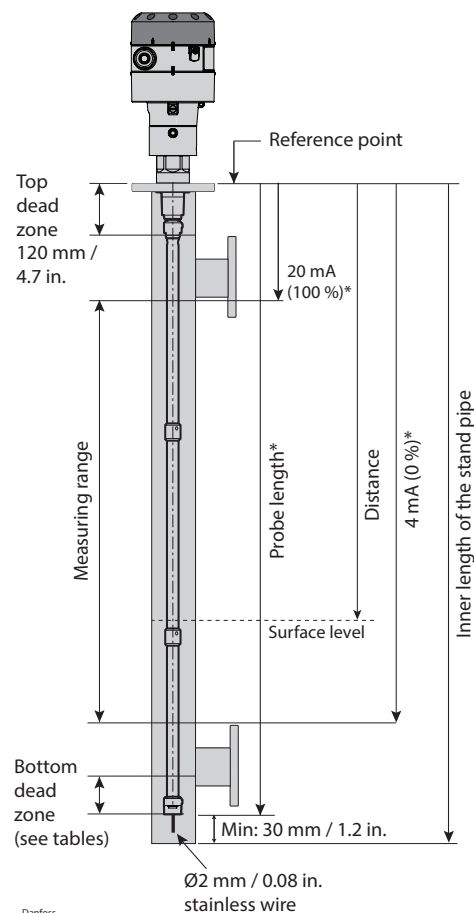

Danfoss M84H0026_1

* Values to be entered into HMI Quick Setup menu and recorded on the setting label. Stick the setting label onto the Signal Converter either inside or outside.

Measuring range of AKS 4100/4100U - COAXIAL D22 version

AKS 4100

Factory setting

Refrigerant	Probe Length		Bottom Dead Zone [mm]	Bottom Dead Zone [in.]
	[mm]	[in.]		
Ammonia	280	11.0	48	1.9

Improved Bottom dead zone values after the adjustment of dielectric constant

Refrigerant	Probe Length		Bottom Dead Zone [mm]	Bottom Dead Zone [in.]
	[mm]	[in.]		
Ammonia	280	11.0	40	1.6

AKS 4100U

Factory setting

Refrigerant	Probe Length		Bottom Dead Zone [in.]	Bottom Dead Zone [mm]
	[in.]	[mm]		
Ammonia	11.0	1.9	48	

Improved Bottom dead zone values after the adjustment of dielectric constant

Refrigerant	Probe Length		Bottom Dead Zone [in.]	Bottom Dead Zone [mm]
	[in.]	[mm]		
Ammonia	11.0	1.6	40	

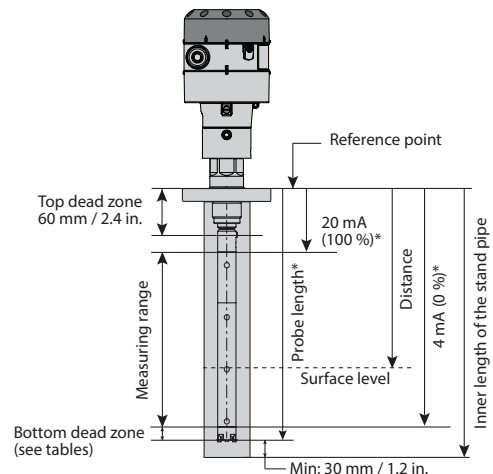

* Values to be entered into HMI Quick Setup menu and recorded on the setting label. Stick the setting label onto the Signal Converter either inside or outside.

Ordering AKS 4100/4100U

Cable version - AKS 4100/4100U



* **When ordering without HMI please observe:**

Each AKS 4100/AKS 4100U must always be programmed via the HMI display unit.

The HMI display unit can be ordered separately:

- **084H4540 / 084H4590**
AKS 4100/4100U HMI display unit with rear cover and mounting bracket. The mounting bracket is very useful when the AKS 4100/4100U have to be programmed. The same AKS 4100/4100U HMI display unit can be used to programme more AKS 4100/4100U and both Cable and Coaxial versions.
- **084H4548 / 084H4598**
AKS 4100/4100U HMI display unit (usually spare part).



Description	Code number with HMI English (default) German French Spanish	Code number with HMI English (default) Japanese Chinese Russian	Code number without HMI
AKS 4100 with 5 m / 197 in., Ø2 mm / Ø0.08 in. stainless cable and counterweight	084H4501	084H4550	084H4500
AKS 4100U with 5 m / 197 in., Ø2 mm / Ø0.08 in. stainless cable and counterweight	084H4521	084H4571	084H4520

Coaxial version - AKS 4100/4100U (available in predefined lengths, with or without HMI)

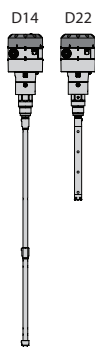

Description	Probe length		Code number with HMI English (default) German French Spanish	Code number with HMI English (default) Japanese Chinese Russian	Code number Without HMI*
	mm	in.			
AKS 4100 - Coaxial D14	500		084H4510	084H4560	084H4503
AKS 4100 - Coaxial D14	800		084H4511	084H4561	084H4504
AKS 4100 - Coaxial D14	1000		084H4512	084H4562	084H4505
AKS 4100 - Coaxial D14	1200		084H4513	084H4563	084H4506
AKS 4100 - Coaxial D14	1500		084H4514	084H4564	084H4507
AKS 4100 - Coaxial D14	1700		084H4515	084H4565	084H4508
AKS 4100 - Coaxial D14	2200		084H4516	084H4566	084H4509
AKS 4100 - Coaxial D22 ¹⁾	280		084H4517	084H4567	084H4518
AKS 4100U - Coaxial D14		19.2	084H4530	084H4580	084H4524
AKS 4100U - Coaxial D14		30	084H4531	084H4581	084H4525
AKS 4100U - Coaxial D14		45	084H4532	084H4582	084H4526
AKS 4100U - Coaxial D14		55	084H4533	084H4583	084H4527
AKS 4100U - Coaxial D14		65	084H4534	084H4584	084H4528
AKS 4100U - Coaxial D14		85	084H4535	084H4585	084H4529
AKS 4100U - Coaxial D22 ¹⁾		11	084H4536	084H4586	084H4537

¹⁾ AKS 4100 Coaxial 280mm and AKS 4100U Coaxial 11 in. are only released for R717/NH₃

Accessories





Description	Code number with HMI English (default) German French Spanish	Code number with HMI English (default) Japanese Chinese Russian
AKS 4100/4100U HMI Service/Display unit with rear cover and mounting bracket	084H4540	084H4590
AKS 4100/4100U HMI Display	084H4548	084H4598
AKS 4100/4100U Signal Converter + Metaglass with HMI, excluding cable gland	084H4555	084H4556
AKS 4100/4100U converter connecting cable (5 pcs.)	084H4557	

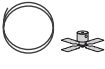

Data sheet | Liquid Level Sensor, type AKS 4100/4100U

Ordering AKS 4100/4100U Continued

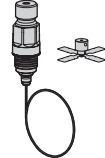
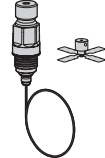
Service kits

Description	Content	Code number
 Cable and counterweight for AKS 4100/4100U - CABLE version	Cable - 5 m / 197 in., Ø2 mm / Ø0.08 in.	084H4542
	Crimp	
	Counterweight	
 End connector incl screws for AKS 4100/4100U - COAXIAL D14 version	End connector (incl. 3 mm / 0.12 in. set screws)	084H4549
 Process connection, counterweight and 5 m / 197 in., Ø2 mm / Ø0.08 in. cable for AKS 4100 - CABLE and COAXIAL D14 version	1 in. process connection	084H4545
	Counterweight	
 Process connection, counterweight and 5 m / 197 in., Ø2 mm / Ø0.08 in. cable for AKS 4100U - CABLE and COAXIAL D14 version	¾ in. NPT process connection	084H4546
	Counterweight	

Other spare parts

Description	Code number
 AKS 4100/4100U Coaxial tube. Tube length : 680 mm / 26.8 in.	084H4543
 AKS 4100/4100U blank top cover for signal converter	084H4544
 AKS 4100/4100U Aluminium gaskets (10 pcs.) for 1in. process connection	084H4547
AKS 4100 1. in. welding connection	027F1010
Process connection AKS 4100 - Coaxial D22 - G1 in. - 280 mm	084H4551
Process connection AKS 4100U - Coaxial D22 - ¾ in. NPT - 11 in.	084H4552

Dimensions and weights

CABLE version

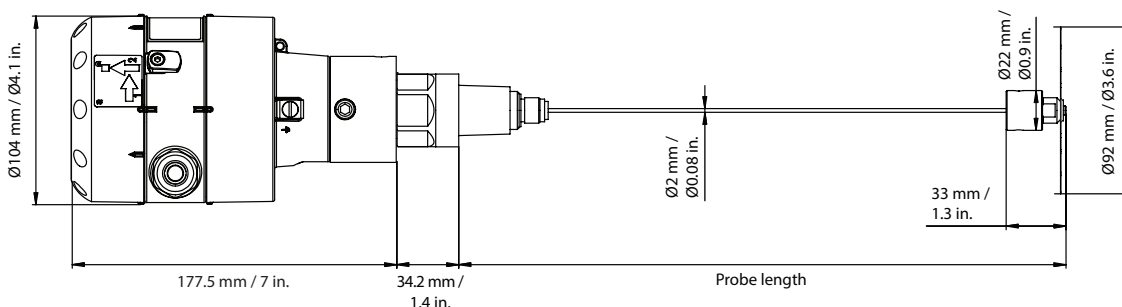

Weight: approx. 2.3 kg / 5.1 lbs

COAXIAL D14 version

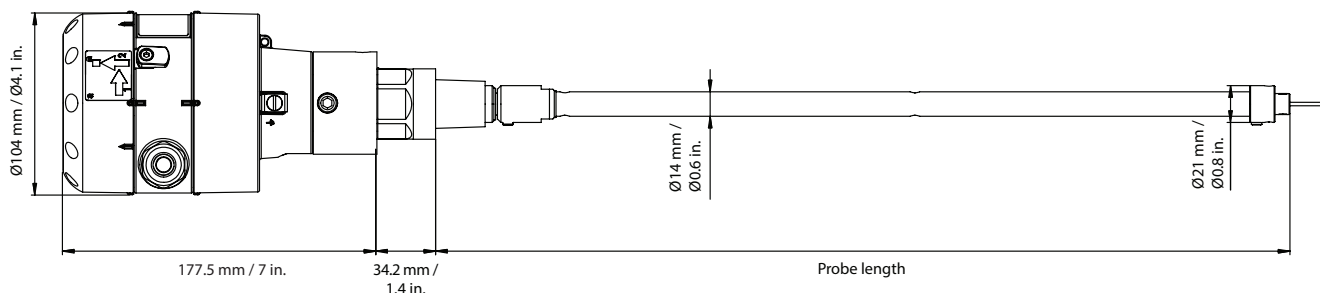

Weight: approx. 3.8 kg / 8.4 lbs

Dimensions and weights (continued)

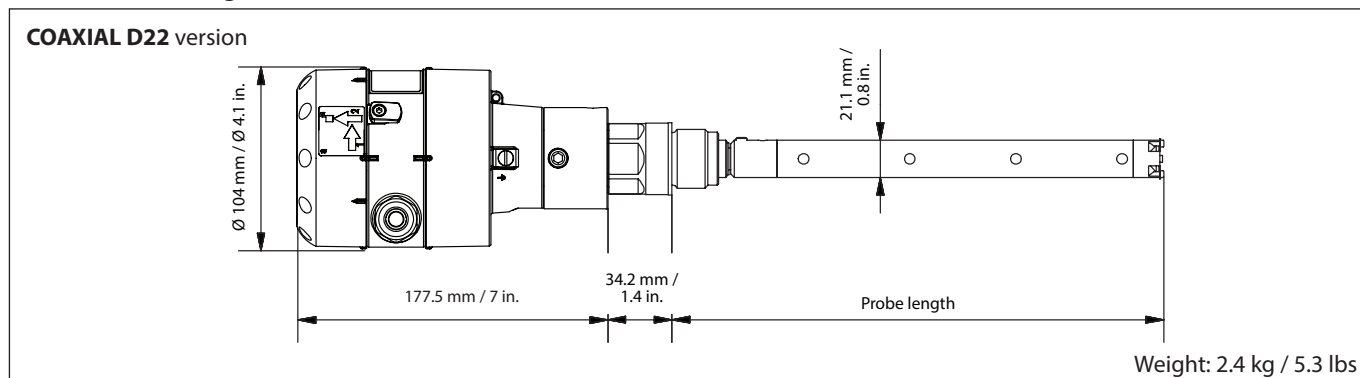

Technical data

Measuring system

Measuring principle	2-wire loop-powered level transmitter; Time Domain Reflectometry (TDR)
Application range	Level measurement of liquid refrigerants. Approved refrigerants: Halogen Free / Environmentally friendly: R717 / NH ₃ , R744 / CO ₂ HCFC and non flammable HFC.
Primary measured value	Time between the emitted and received signal
Secondary measured value	Distance or level

Design

Options	<p>Probe types</p> <p><i>Cable</i> Mechanical process connection with 5 m / 197 in., Ø2 mm / 0.08 in. stainless cable: Mechanical thread on the mechanical process connection AKS 4100: G1 in. pipe thread. Aluminium gasket included AKS 4100U: ¾ in. NPT</p> <p><i>Coaxial D14</i> Mechanical process connection with 5 m / 197 in., Ø2 mm / 0.08 in. stainless cable and 14 mm / 0.55 in. outer stainless tube: Mechanical thread on the mechanical process connection AKS 4100: G1 in. pipe thread. Aluminium gasket included AKS 4100U: ¾ in. NPT Stainless steel tubes supporting the available probe length</p> <p><i>Coaxial D22</i> Mechanical process connection with in 22 mm / 0.87 in. outer stainless tube. 8 mm / 0.3 in. inner rod. Mechanical thread on the mechanical process connection AKS 4100: G1 in. pipe thread. Aluminium gasket included AKS 4100U: ¾ in. NPT</p> <p>LCD display</p>
Insertions (probe) length	<p><i>Coaxial D14</i> AKS 4100: 500, 800, 1000, 1200, 1500, 1700 and 2200 mm AKS 4100U: 19.2, 30, 45, 55, 65, 85 in.</p> <p><i>Coaxial D22</i> AKS 4100: 280 mm AKS 4100U: 11.0 in.</p> <p>Single cable Ø2 mm / 0.08 in.: 800 – 5000 mm / 31.5-197 in.</p>
Dead zone	This depends on the type of probe. (see pages 7 and 8)

Display and User interface

Display	Integrated LCD display 128 x 64 pixels in 8-step greyscale with 4-button keypad
Interface languages	English (default), German, French, Spanish, Japanese, Chinese, Russian

Operating conditions

Temperature:

Ambient temperature	-40 – 80 °C / -40 – 175 °F For HMI: -20 – 60 °C / -4 – 140 °F
Storage temperature	-40 – 85 °C / -40 – 185 °F
Process connection temperature	Standard -60 – 100 °C / -76 – 212 °F

Pressure:

Operating pressure	Standard: -1 – 100 barg / -14.5 – 1450 psig
--------------------	---

Data sheet | Liquid Level Sensor, type AKS 4100/4100U

Technical data (continued)

Other conditions:

Liquid dielectric constant (ϵ_r)	Cable version to be used in R717 / NH ₃ , HCFC and HFC ϵ_r , liquid > 5.6 Coaxial version is mandatory in R744 / CO ₂ ϵ_r , liquid > 1.3
Vibration resistance	EN 60721-3-4 (1...9 Hz: 3 mm / 10...200 Hz: 1g; 10g shock half-wave sinusoidal: 11 ms)
Protection category	IP 66/67 equivalent to NEMA type 4X (housing) and type 6P (probe)

Installation conditions

Dimensions and weights	See pages 10 and 11
------------------------	---------------------

Material

Housing	Aluminium
Coaxial D14 and D22 version	Standard: Stainless steel (1.4404 / 316L)
Single cable	Standard: Stainless steel (1.4401 / 316)
Process fitting	Standard: Stainless steel (1.4404 / 316L)
Gaskets	EPDM (-50 – 150 °C / -58 – 300 °F)
Cable gland	Plastic (black)

Process connections

Thread:

Single cable Ø2 mm / 0.08"	AKS 4100: G1 inch pipe thread. Aluminium gasket included AKS 4100U: ¾ in. NPT
Coaxial D14 and D22 version	AKS 4100: G1 inch pipe thread. Aluminium gasket included AKS 4100U: ¾ in. NPT

Electrical connections

Power supply	Terminals output: 14 – 30 V DC. Min./Max. Value for an output of 22 mA at the terminal. Ambient temperature limitations: -40 – 80 °C / -40 – 176 °F : 16 – 30 V DC -20 – 80 °C / -4 – 176 °F : 14 – 30 V DC
Current output load	RL [Ω] ≤ ((U _{ext} - 14 V) / 20 mA). – Default (Error output set to 3.6 mA) RL [Ω] ≤ ((U _{ext} - 14 V) / 22 mA). – (Error output set to 22 mA)
Cable gland	AKS 4100: PG 13, M20×1.5; (cable diameter: 6 – 8 mm / 0.24 – 0.31 in.) AKS 4100U: ½ in. NPT
Cable entry capacity (terminal)	0.5 – 1.5 mm ² (~20-15 AWG)

Input and output

Current output:

Output signal	4...20 mA or 3.8...20.5 mA acc. to NAMUR NE 43
Resolution	±3 µA
Temperature drift	Typically 75 ppm/K
Error signal	High: 22 mA; Low: 3.6 mA acc. to NAMUR NE 43; Hold (frozen value - not available with NAMURNE 43 compliant output.

Approvals and certification

	This device fulfills the statutory requirements of the EMC directives. The manufacturer certifies successful testing of the product by applying the CE mark.
<i>Valid for AKS 4100 - Not valid for AKS 4100U:</i>	
	Pattern Approval Certificate of Measuring Instruments for the Russian Federation
	In compliance with EMC regulations in the Russian Federation

Other standards and approvals:

EMC	EMC Directives 2004 / 108 / EC and 93 / 68 / EEC in conjunction with EN 61326-1 (2006) and EN 61326-2-3 (2006). The device conforms to these standards if: - the device has a coaxial probe or - the device has a single probe that is installed in a metallic tank.
LVD	Low-Voltage Directives 2006 / 95 / EC and 93 / 68 / EEC in conjunction with EN 61010-1 (2001)
NAMUR	NAMUR NE 21 Electromagnetic Compatibility (EMC) of Industrial Process and Laboratory Control Equipment NAMUR NE 43 Standardization of the Signal Level for the Failure Information of Digital Transmitters

Technical data
(continued)

Minimum power supply voltage

Use this graph to find the minimum power supply voltage for a given current output load:

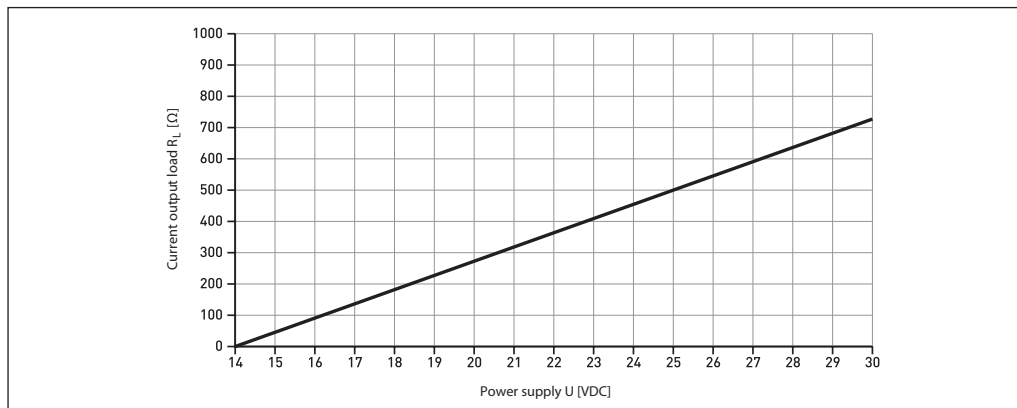

Minimum power supply voltage for an output of 22mA at the terminal

Note:

The signal converter can be programmed with or without mechanical process connector assembled.

Quick Setup (all values below are only examples)

- Connect the device to the power supply (see the section "Electrical installation/connection").

- Press **→** 3 times.

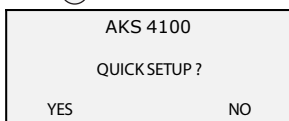

- Press **→**

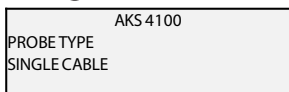

- Press **↓** or **↑** to select between SINGLE, COAXIAL D14 and COAXIAL D22. Choose **SINGLE** and press **↵** to confirm.

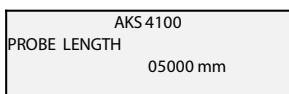

- Press **→** to change the PROBE LENGTH. Press **→** to change the position of the cursor. Press **↓** to decrease the value or **↑** to increase the value. Press **↵** to confirm.

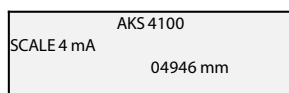

- Press **→** to change of SCALE 4 mA. Press **→** to change the cursor position. Press **↓** to decrease the value or **↑** to increase the value. Press **↵** to confirm.

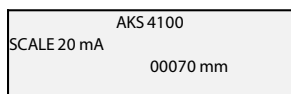

- Press **→** to change of SCALE 20 mA. Press **→** to change the cursor position. Press **↓** to decrease the value or **↑** to increase the value. Press **↵** to confirm.

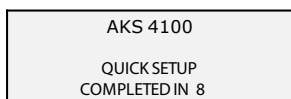

- Wait for QUICK SETUP to complete 8-second timeout

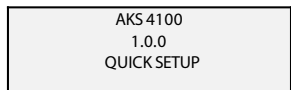

- Press **↵** to confirm.



- Press **↓** or **↑** to select either STORE NO or STORE YES. Press **↵** to confirm.

Default screen appears:

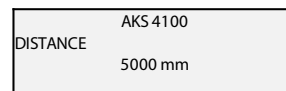

Quick Setup completed

You have the possibility of checking your settings by pressing **→** twice.

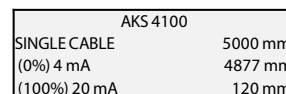

- Press **↵** **←** **↵** to return to default screen.

Note: The signal converter can be programmed with or without mechanical process connector assembled.

Quick Setup (all values below are only examples)

When CO₂ is used:

- Connect the device to the power supply (see the section "Electrical installation/connection").

- Press **→** 3 times.

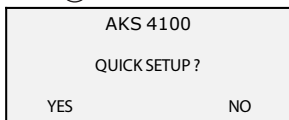

- Press **→**



- Press **↓** or **↑** to select between SINGLE, COAXIAL D14 and COAXIAL D22. Choose **COAXIAL D14** and press **←** to confirm.

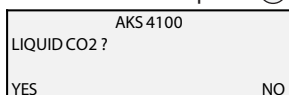

- Press **→** (YES) to confirm

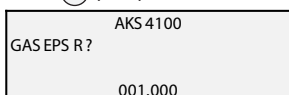

- Press **→** to change GAS EPS.R. (Select the correct value from the tables on page 8)
Press **→** to change cursor-position.
Press **↓** to decrease the value or **↑** to increase the value.

- Press **←** to confirm.

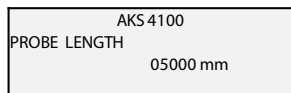

- Press **→** to change the PROBE LENGTH. Press **→** to change the position of the cursor. Press **↓** to decrease the value or **↑** to increase the value. Press **←** to confirm.

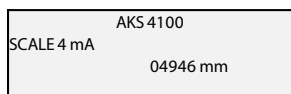

- Press **→** to change of SCALE 4 mA. Press **→** to change the cursor position. Press **↓** to decrease the value or **↑** to increase the value. Press **←** to confirm.

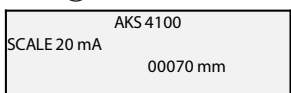

- Press **→** to change of SCALE 20 mA. Press **→** to change the cursor position. Press **↓** to decrease the value or **↑** to increase the value. Press **←** to confirm.

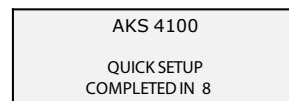

- Wait for QUICK SETUP to complete. Count down from 8 sec.

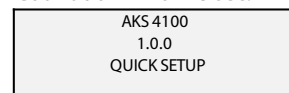

- Press **←** to confirm.



- Press **↓** or **↑** to select between STORE NO or STORE YES. Press **←** to confirm.

Default screen appears:

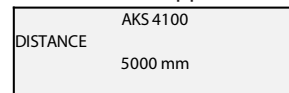

Quick Setup completed

You have the possibility of checking your settings by pressing **→** twice.

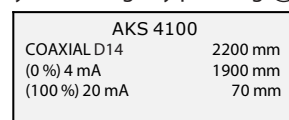

Press **←** **↑** **←** to return to default screen.

For all other refrigerants (please note that Coaxial D22 version can only be used in R717/NH₃):

- Connect the device to the power supply (see the section "Electrical installation/connection").

- Press 3 times.

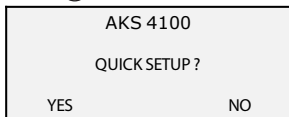

- Press .

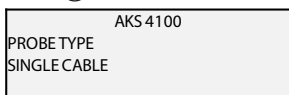

- Press or to select between SINGLE, COAXIAL D14 and COAXIAL D22. Choose **COAXIAL D14** and press to confirm.

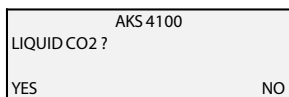

- Press (NO) to confirm

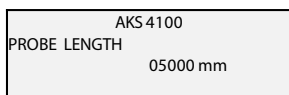

- Press to change the PROBE LENGTH. Press to change the position of the cursor. Press to decrease the value or to increase the value. Press to confirm.

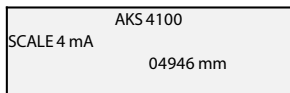

- Press to change of SCALE 4 mA. Press to change the cursor position. Press to decrease the value or to increase the value. Press to confirm.

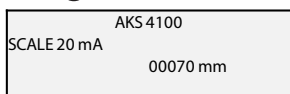

- Press to change of SCALE 20 mA. Press to change the cursor position. Press to decrease the value or to increase the value. Press to confirm.

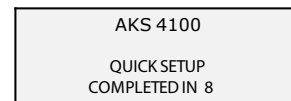

- Wait for QUICK SETUP to complete. Count down from 8 sec.

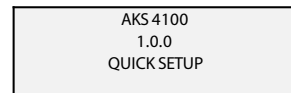

- Press .



- Press or to select between STORE NO or STORE YES. Press .

Default screen appears:

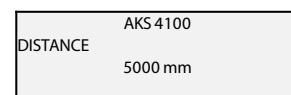

Quick Setup completed

CABLE and COAXIAL version

Forcing mA output (all values below are only examples)

<p>Default screen</p> <div style="border: 1px solid black; padding: 5px; width: fit-content;"> AKS 4100 DISTANCE 5000 mm </div> <p>• Press </p> <div style="border: 1px solid black; padding: 5px; width: fit-content;"> AKS 4100 1.0.0 QUICK SETUP </div> <p>• Press </p> <div style="border: 1px solid black; padding: 5px; width: fit-content;"> AKS 4100 2.0.0 SUPERVISOR </div> <p>• Press </p> <div style="border: 1px solid black; padding: 5px; width: fit-content;"> AKS 4100 2.0.0 _____ </div> <p>Enter password:</p> <div style="display: flex; justify-content: space-around; width: 100px;"> </div> <div style="border: 1px solid black; padding: 5px; width: fit-content;"> AKS 4100 2.1.0 INFORMATION </div>	<p>• Press </p> <div style="border: 1px solid black; padding: 5px; width: fit-content;"> AKS 4100 2.2.0 TESTS </div> <p>• Press </p> <div style="border: 1px solid black; padding: 5px; width: fit-content;"> AKS 4100 2.2.1 SET OUTPUT </div> <p>• Press </p> <div style="border: 1px solid black; padding: 5px; width: fit-content;"> AKS 4100 SET OUTPUT 3.5 mA </div> <p>• Press to decrease the value or to increase the value. Press to confirm.</p> <div style="border: 1px solid black; padding: 5px; width: fit-content;"> AKS 4100 SET OUTPUT 8 mA </div>	<p>• Press 4 times to return to default screen.</p> <p>Default screen appears:</p> <div style="border: 1px solid black; padding: 5px; width: fit-content;"> AKS 4100 DISTANCE 5000 mm </div> <p>Force mA completed and disabled</p>
--	--	---

Optional Procedure

If the temperature condition in the stand pipe is known, a constant (dielectric constant of the refrigerant gas) **can be** entered (parameter 2.5.3 GAS EPS.R), in order to obtain lower Top and Bottom Dead Zone values (see pages 7 and 8).

Entering refrigerant dielectric gas constant (all values below are only examples)

<p>Default screen</p> <div style="border: 1px solid black; padding: 5px; width: fit-content;"> AKS 4100 DISTANCE 5000 mm </div> <p>• Press </p> <div style="border: 1px solid black; padding: 5px; width: fit-content;"> AKS 4100 1.0.0 QUICK SETUP </div> <p>• Press </p> <div style="border: 1px solid black; padding: 5px; width: fit-content;"> AKS 4100 2.0.0 SUPERVISOR </div> <p>• Press </p> <div style="border: 1px solid black; padding: 5px; width: fit-content;"> AKS 4100 2.0.0 _____ </div> <p>Enter password:</p> <div style="display: flex; justify-content: space-around; width: 100px;"> </div> <div style="border: 1px solid black; padding: 5px; width: fit-content;"> AKS 4100 2.1.0 INFORMATION </div>	<p>• Press 4 times.</p> <div style="border: 1px solid black; padding: 5px; width: fit-content;"> AKS 4100 2.5.0 APLICATION </div> <p>• Press </p> <div style="border: 1px solid black; padding: 5px; width: fit-content;"> AKS 4100 2.5.1 TRACING VEL. </div> <p>• Press 2 times.</p> <div style="border: 1px solid black; padding: 5px; width: fit-content;"> AKS 4100 2.5.3 GAS EPS. R </div> <p>• Press to change GAS EPS.R. (Select the correct value from the tables on page 16) Press to change cursor-position. Press to decrease the value or to increase the value.</p> <div style="border: 1px solid black; padding: 5px; width: fit-content;"> AKS 4100 GAS EPS. R 1.066 </div>	<p>• Press to confirm.</p> <div style="border: 1px solid black; padding: 5px; width: fit-content;"> AKS 4100 2.5.3 GAS EPS. R </div> <p>• Press 3 times.</p> <div style="border: 1px solid black; padding: 5px; width: fit-content;"> AKS 4100 1.0.0 STORE NO </div> <p>• Press or to select between STORE NO or STORE YES. Select STORE YES by pressing </p> <p>Default screen appears:</p> <div style="border: 1px solid black; padding: 5px; width: fit-content;"> AKS 4100 DISTANCE 5000 mm </div> <p>Entering the dielectric constant of refrigerant gas completed</p>
--	--	--

Saturated vapour dielectric constant (default value: 1.066)

R717 (NH₃)

Temperature range:
-60 – 50 °C / -76 – 122 °F

Temperature [°C]	Temperature [°F]	Dielectric constant of refrigerant gas Parameter 2.5.3 GAS EPS.R
-60 – -42	-76 – -43	1.00
-41 – -18	42 – 0	1.01
-17 – -5	1 – 23	1.02
-4 – 4	24 – 39	1.03
5 – 12	40 – 54	1.04
13 – 18	55 – 64	1.05
19 – 24	65 – 75	1.06
25 – 28	76 – 82	1.07
29 – 33	83 – 91	1.08
34 – 37	92 – 99	1.09
38 – 40	100 – 104	1.10
41 – 44	105 – 111	1.11
45 – 47	112 – 117	1.12
48 – 50	118 – 122	1.13

R22

Temperature range:
-60 – 48 °C / -76 – 118 °F

Temperature [°C]	Temperature [°F]	Dielectric constant of refrigerant gas Parameter 2.5.3 GAS EPS.R
-60 – -50	-76 – -58	1.00
-49 – -25	57 – -13	1.01
-24 – -10	-12 – 14	1.02
-9 – 0	15 – 32	1.03
1 – 8	33 – 46	1.04
9 – 15	47 – 59	1.05
16 – 21	60 – 70	1.06
22 – 26	71 – 79	1.07
27 – 31	80 – 88	1.08
32 – 35	89 – 95	1.09
36 – 39	96 – 102	1.10
40 – 42	103 – 108	1.11
43 – 45	109 – 113	1.12
46 – 48	114 – 118	1.13

R410A

Temperature range:
-65 – 15 °C / -85 – 59 °F

Temperature [°C]	Temperature [°F]	Dielectric constant of refrigerant gas Parameter 2.5.3 GAS EPS.R
-65 – -47	-85 – -52	1.01
-46 – -35	-51 – -31	1.02
-34 – -26	-30 – -14	1.03
-25 – -19	-13 – -2	1.04
-18 – -13	-1 – 9	1.05
-12 – -8	10 – 18	1.06
-7 – -4	19 – 25	1.07
-3 – 0	26 – 32	1.08
1 – 4	33 – 40	1.09
5 – 7	41 – 45	1.10
8 – 10	46 – 50	1.11
11 – 12	51 – 54	1.12
13 – 15	55 – 59	1.13

R507

Temperature range:
-60 – 15 °C / -76 – 59 °F

Temperature [°C]	Temperature [°F]	Dielectric constant of refrigerant gas Parameter 2.5.3 GAS EPS.R
-60 – -48	-76 – -54	1.01
-47 – -36	-53 – -32	1.02
-35 – -28	-31 – -18	1.03
-27 – -21	-17 – -6	1.04
-20 – -15	-17 – -5	1.05
-14 – -10	-4 – 14	1.06
-9 – -6	13 – 22	1.07
-5 – -2	23 – 29	1.08
-1 – 2	30 – 36	1.09
3 – 5	37 – 41	1.10
6 – 8	42 – 47	1.11
9 – 11	48 – 52	1.12
12 – 13	53 – 56	1.13
14 – 15	57 – 59	1.14

R744 (CO₂)

Temperature range:
-56 – 15 °C / -69 – 59 °F

Temperature [°C]	Temperature [°F]	Dielectric constant of refrigerant gas Parameter 2.5.3 GAS EPS.R
-56.0 – -42.0	-69 – -43	1.01
-41.0 – -28.0	-42 – -18	1.02
-27.0 – -17.0	-17 – 2	1.03
-16.0 – -9.0	3 – 16	1.04
-8.0 – -3.0	17 – 27	1.05
-2.0 – 2	28 – 36	1.06
3 – 7	37 – 45	1.07
8 – 11	46 – 52	1.08
12 – 14	53 – 58	1.09
15	59	1.10

R134a

Temperature range:
-60 – 50 °C / -76 – 122 °F

Temperature [°C]	Temperature [°F]	Dielectric constant of refrigerant gas Parameter 2.5.3 GAS EPS.R
-60 – -42	-76 – -43	1.00
-41 – -18	-42 – 0	1.01
-17 – -4	1 – 25	1.02
-3 – 5	26 – 41	1.03
6 – 13	42 – 56	1.04
14 – 20	57 – 68	1.05
21 – 25	69 – 77	1.06
26 – 30	78 – 86	1.07
31 – 34	87 – 94	1.08
35 – 38	95 – 100	1.09
39 – 42	101 – 108	1.10
43 – 45	109 – 113	1.11
46 – 48	114 – 119	1.12
49 – 50	120 – 122	1.13

R404A

Temperature range:
-60 – 15 °C / -76 – 59 °F

Temperature [°C]	Temperature [°F]	Dielectric constant of refrigerant gas Parameter 2.5.3 GAS EPS.R
-60 – -47	-76 – -52	1.01
-46 – -35	-51 – -31	1.02
-34 – -26	-30 – -14	1.03
-25 – -19	-13 – -2	1.04
-18 – -14	-1 – 7	1.05
-13 – -9	8 – 16	1.06
-8 – -4	17 – 25	1.07
-3 – 0	26 – 32	1.08
1 – 3	33 – 38	1.09
4 – 6	39 – 43	1.10
7 – 9	44 – 49	1.11
10 – 12	50 – 54	1.12
13 – 15	55 – 59	1.13

How to change the language setting (Default: English)

Default screen



• Press

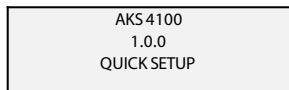

• Press

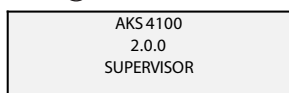

• Press

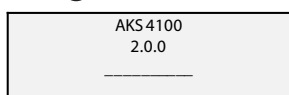

Enter password:

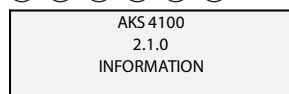

• Press 6 times

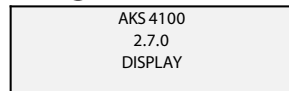

• Press

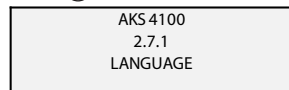

• Press

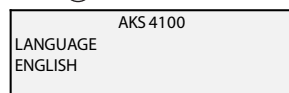

• Press or to see the language possibilities
Press to confirm.

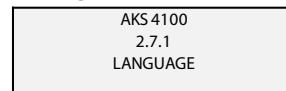

• Press 3 times



• Press or to select between STORE NO or STORE YES.

Select STORE YES by pressing

Default screen appears:



Language setup completed

Reset to factory setting

- Go to SUPERVISOR menu (see page 16).
- Go to parameter 2.9.4 Reset Factory.
- Select RESET FACTORY YES
- Press 3 times to return to default screen.

Factory reset completed.

ENGINEERING
TOMORROW



Danfoss can accept no responsibility for possible errors in catalogues, brochures and other printed material. Danfoss reserves the right to alter its products without notice. This also applies to products already on order provided that such alterations can be made without subsequential changes being necessary in specifications already agreed. All trademarks in this material are property of the respective companies. Danfoss and the Danfoss logotype are trademarks of Danfoss A/S. All rights reserved.