



O & M Manual



PortaSense III

Portable Gas Leak Detector

Home Office

Analytical Technology, Inc.
6 Iron Bridge Drive
Collegeville, PA 19426
Phone: 800-959-0299
610-917-0991
Fax: 610-917-0992
Email: sales@analyticaltechnology.com
Web: www.Analyticaltechnology.com

European Office

ATI (UK) Limited
Unit 1 & 2 Gatehead Business Park
Delph New Road, Delph
Saddleworth OL3 5DE
Phone: +44 (0)1457-873-318
Fax: + 44 (0)1457-874-468
Email: sales@atiuk.com

Table of Contents

SPECIFICATIONS	4	SENSOR	30
REFERENCE DRAWINGS	5	Range.....	31
INTRODUCTION	8	Blanking	31
D16 PORTASENS III	8	Averaging.....	32
Inlet and Outlet Ports.....	8	Configuring the Sensor.....	32
H10 SENSOR	9	Calibration	34
Electro-chemical Cell Versions	9	Factory Calibration Services.....	34
Installing the Sensor.....	9	Owner Calibrations	35
OPERATION	10	Pressurized Gas Sources.....	35
STARTUP	10	Sensor Calibration Steps	36
SHUTDOWN	11	Calibration History.....	37
MAIN DISPLAY	11	H10 Sensor Response Times.....	40
Gas Reading, Units, Name, and Temperature .	11	Gas Interferences	41
Gas Alarm Indicators	12	Response Test	43
Meter	13	H10 Sensors and D12 or F12 Transmitters.....	44
Battery Indicator.....	13	SYSTEM	44
Status Messages	13	System “About” Page.....	44
Date and Time	14	Date and Time	44
Display Background	14	Auto-shutdown	44
Buttons.....	14	Sound	45
MAIN MENU	15	Default Settings	45
DISPLAY	15	Configuring System Settings	45
Brightness	15	TIMED SAMPLING	49
Main Display Appearance	16	Description	49
Menu Timeout	17	Operation.....	49
Sleep Mode	17	Configuring Timed Sampling.....	51
Troubles	17	POWER	52
Configuring the Display.....	18	NiMH Battery.....	52
ALARMS	21	USB Power	52
Danger Alarm.....	22	Shutdown.....	52
Warning Alarm	22	MAINTENANCE	53
Caution Alarm.....	22	INTAKE FILTER	53
Configuring Alarms	23	BATTERY CONTACTS	53
DATA LOG	24	TROUBLES AND EXCEPTIONS	54
USB Mode	24	TROUBLE MESSAGES	54
Directory Structure.....	25	PUMP TROUBLES	55
File Structure.....	26	OTHER TROUBLES	56
Configuring the Data Logger	27	GENERAL CORRECTIVE ACTIONS	57
PUMP	28	EXCEPTION MESSAGES	58
Pump Status.....	28	SPARE PARTS	60
Configuring the Pump.....	29	H10 GAS SENSOR MODULES	61

Table of Figures

Figure 1. PortaSens III, front view. _____	5
Figure 2. PortaSens III, rear view. _____	5
Figure 3. PortaSens III, right side view. _____	6
Figure 4. H10 gas sensor module (ordered separately). _____	7
Figure 5. Sensor Keeper. _____	7
Figure 6. Flow meter. _____	7
Figure 7 Model D16, PortaSens III Gas Leak Detector. _____	8
Figure 8. H10 "Smart Sensor" module. _____	9
Figure 9 Sensor Keeper. _____	9
Figure 10 D16 startup displays. _____	10
Figure 11 Main Display page indications (example) _____	11
Figure 12 Data log control button _____	14
Figure 13 Adjusting brightness by swiping. _____	15
Figure 14 Meter styles - Normal (a), and % FS (b). _____	16
Figure 15 USB mode display. _____	24
Figure 16 Data logger file structure. _____	25
Figure 17 Example data log file opened with Microsof Excel. _____	26
Figure 18 Pump status on "Main Display". _____	28
Figure 19 Sensor Information page. _____	30
Figure 20. Gas source connection. _____	35
Figure 21 System About page. _____	44
Figure 22 Trouble page. _____	54

SPECIFICATIONS

Gas Sensor	H10 "Smart Sensor" gas Modules, ordered separately
Range	Sensor Dependent (see H10 Gas Sensor Modules on page 61, or contact the manufacturer)
Display	Backlighted, resistive touch-sensitive, 320x240 color graphics LCD with an anti-glare overlay. Custom overlay and graphic logo available.
Accuracy	Sensor dependent (typically $\pm 5\%$ of value, limited by cal. gas)
Sensitivity	1% of (lowest) sensor module range
Repeatability	$\pm 1\%$ of (lowest) sensor module range
Sampling Pump	Internal diaphragm pump, 400 cc/min (0.85 SCFH), adjustable. Long life, variable speed, DC motor
Alarms	Three level alarms, configurable for high or low operation, or disabled Trouble, low battery, restricted flow alarms. Alarm indications on LCD and beeper
Data Logger	Internal 4Gb Selectable sampling intervals from 10 seconds to 60 minutes
Sample/Measure	Self-timed sample/measure mode for repeatable readings
Real-Time Clock	Battery backed, accurate to approximately 1 minute per year
Input/Output	USB 2.0 MSD Class interface with 1m mini-USB cable
Power	D-cell battery, rechargeable*, NiMH, 10,000mAh 10-12 hours continuous operation 90 days shelf-life (fully charged, no sensor) May also use non-rechargeable, D-cell alkaline *External charger required (available option) Note: USB connection provides power, but does not charge battery
Sound	Inter beeper
Operating Temp.	-25° to +60° C
Humidity	0-95% Non-condensing
Construction	Glass filled nylon, PVC, and stainless steel
Shipping Weight	4.9 lbs / 2.22 kg (complete package)

Reference Drawings

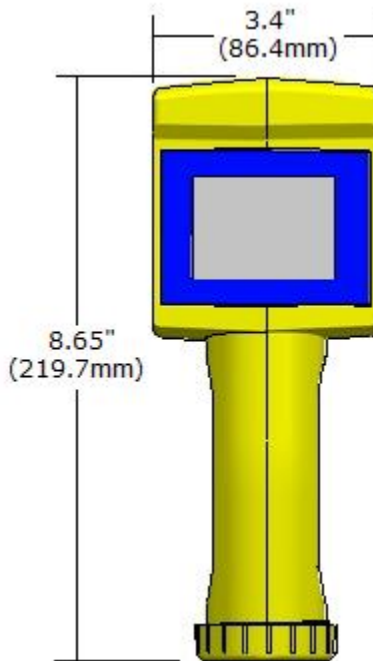

Figure 1. PortaSens III, front view.

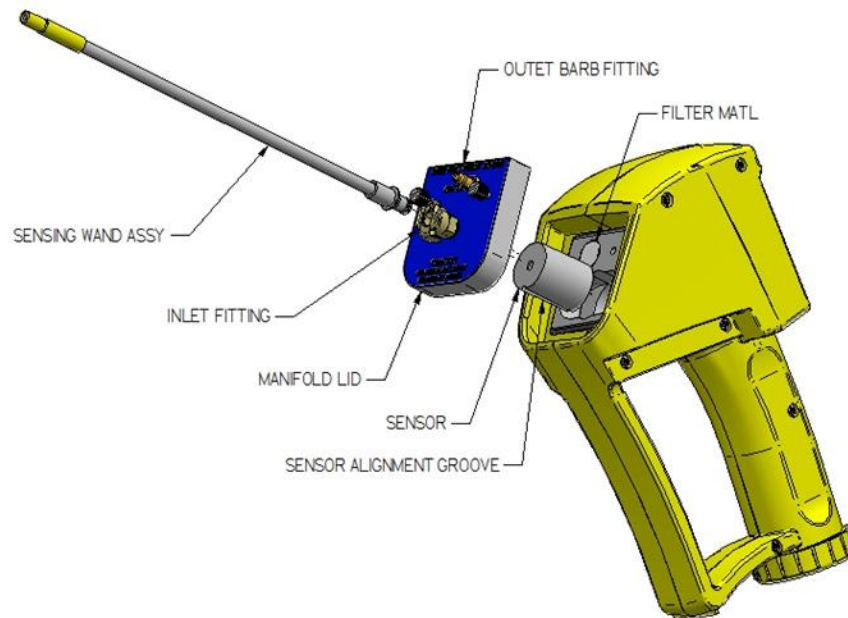

Figure 2. PortaSens III, rear view.

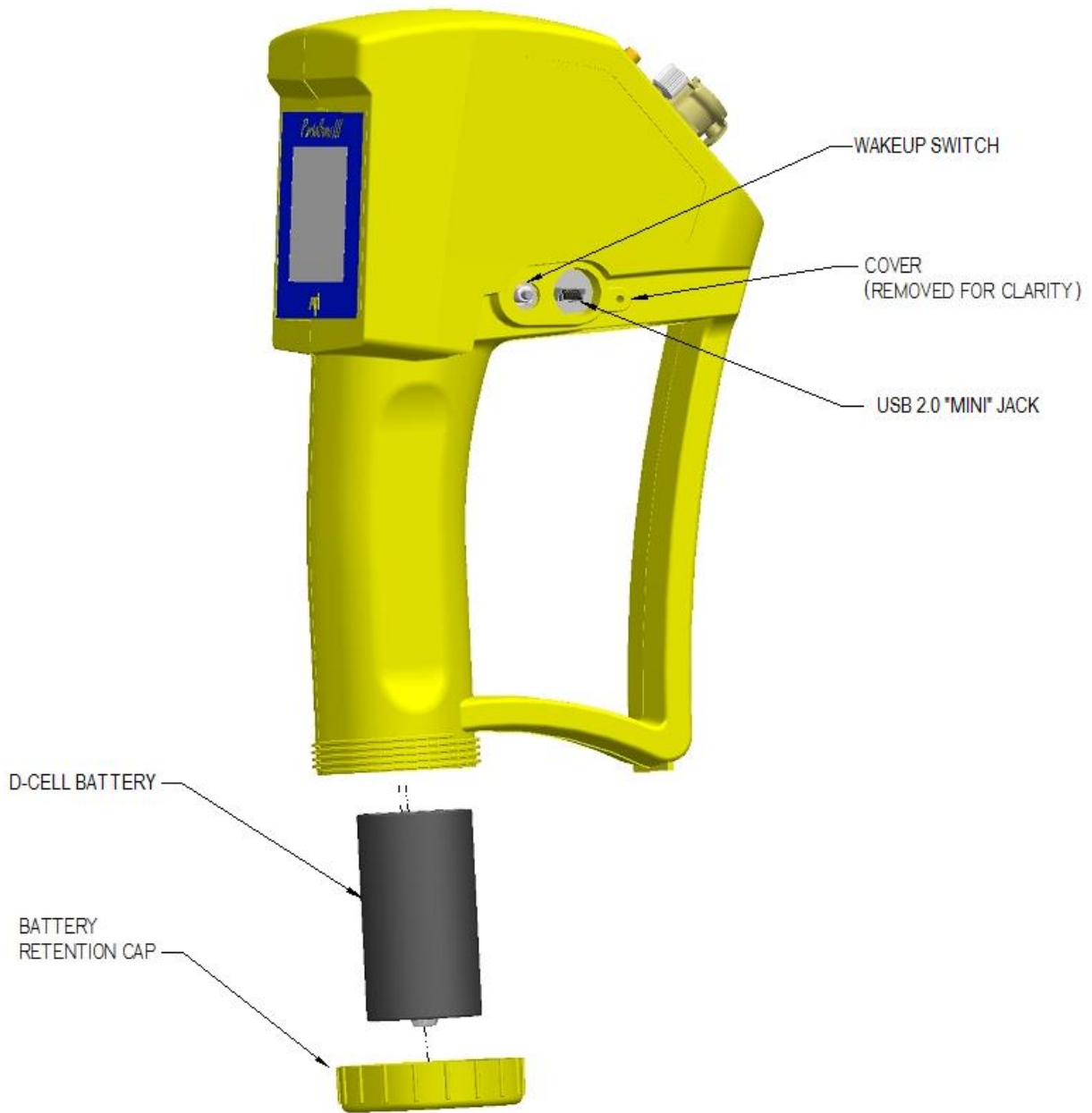

Figure 3. PortaSens III, right side view.



Figure 4. H10 gas sensor modules (sold separately)
a) Electrochemical, b) Infrared

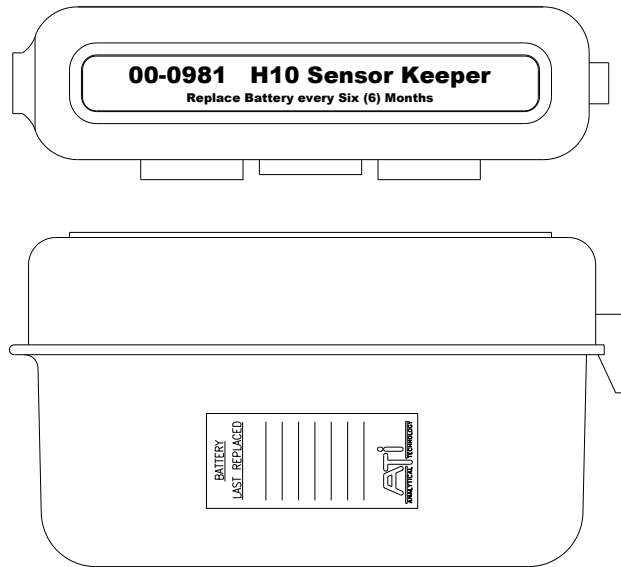

Figure 5. Sensor Keeper (not for use with infrared sensors).

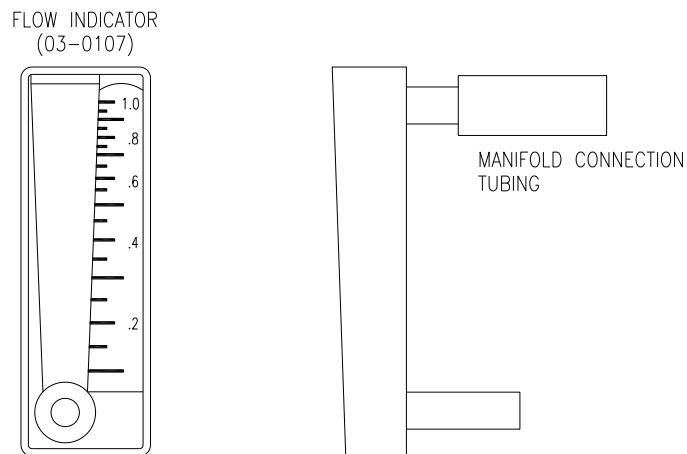

Figure 6. Flow meter.

INTRODUCTION

D16 PortaSens III

The D16 *PortaSens III* is a rugged, hand-held device used to detect leaks of toxic, or otherwise dangerous gas, and also to detect oxygen displacement (or deprivation).



Figure 7 Model D16, PortaSens III Gas Leak Detector.

The D16 quickly adapts to measure different gasses by inserting the appropriate H10 gas sensor module, which retains all of the calibration and configuration settings for the target gas.

An internal pump with a flexible wand is included for point sampling around suspect pipe fittings and confined spaces.

Readings and settings are presented on a backlit, resistive touch, color graphics LCD, with a beeper to notify you of alarms and other events.

Readings are recorded in .csv files (ASCII text, comma-separated values) and transferred to a PC using the supplied USB cable. No external application is required. The files may be opened with any text editor, or

directly by applications like Microsoft Excel®.

Power is provided from a rechargeable, NiMH D-cell battery. The battery should be removed and charged in an external charger after each use. The battery is not used or even required when the device is connected to a USB port.

Inlet and Outlet Ports

The inlet port, located on the manifold lid, is fitted with a quick-disconnect fitting to connect the flexible wand (see Figure 2 on page 5). The wand can be used for probing closely around pipes and fittings, and for sampling confined spaces without entering. The wand is lined with Teflon™ and is inert to nearly all vapors and gasses.

Flexible tubing may be connected to the inlet port to sample high gas concentrations, or those beyond the reach of the wand. Fluorocarbon-based tubing is strongly recommended for measuring low concentrations of reactive gases. Other materials may be used for high range measurements, where the adsorption of gas by the tubing is negligible, or where you are probing for significant leaks.

The internal walls of the wand and any inlet tubing must be kept dry. Water on the walls may absorb soluble gases and decrease the gas readings, presenting an unsafe condition. If the inside of the wand or tubing gets wet, draw dry air through it for 10 to 15 minutes.

Keep the inlet and outlet ports free of obstructions.

H10 Sensor

The D16 measures gas concentration levels using H10 “Smart Sensor” modules. H10 sensors store their calibration and configuration settings, such as, zero, span, range, and alarm levels, in their memory. This allows them to be changed quickly to detect leaks of different toxic gasses, or to detect oxygen deficiency caused by deprivation or displacement. Gas sensor modules must be ordered separately. For a complete list of modules and their operating range, see H10 Gas Sensor Modules on page 61.



Figure 8. H10 "Smart Sensor" module.

Sensor modules are calibrated at the factory and require only a routine calibration, which may be performed by trained personnel on site using traceable gas standards and methods. A more economical solution may be to return them periodically to the factory for certified calibration. Contact the factory for details about the certified calibration program for H10 sensors.

H10 Sensor Cells

H10 sensors contain either an electro-chemical or infrared cell. The electrochemical cell versions must remain powered to maintain proper sensitivity to the target gas. Left unpowered, it may take several hours for the sensor output to return to normal. The D16 powers the sensor while in use, but afterwards, the sensor should be removed and placed in the

“Sensor Keeper”. Infrared cells consume significantly more power than electrochemical cells. H10 sensors with infrared cells should be removed from the D16 and stored unpowered, and never in the sensor keeper. Sensor cell types are identified in Table 28 on page 61. Contact the factory if an H10 sensor is not listed there.

Up to four electro-chemical cell type sensors may be stored in the keeper, which maintains them “on bias” and ready for use.



Figure 9 Sensor Keeper.

Electro-chemical cell based sensors should be stored in the Sensor Keeper to maintain bias. Never store infrared cell based sensors in the Sensor Keeper.

Installing the Sensor

Loosen the two thumb screws on the back of the D16 and remove the manifold shown in Figure 2 on page 5 and. If a sensor module is already installed, pull straight up to remove it. Insert the new sensor module into the recess, connector end first. Rotate it to align the groove with the guide pin, and then press down to seat the connector. The top of the sensor module should be flush with the top of the opening. Replace the manifold and hand-tighten the thumb screws.

OPERATION

The D16 features a touch-sensitive, color graphics display that is organized into pages to configure and operate the device. The primary operational information, consisting of the gas reading and alarm indicators, appears on the “Main Display” page. Configuration settings, and other operational displays, appear on pages accessed through the menu system by touching the “Menu” button.

D16 pages are normally presented on a dark background. Pages depicted below appear on a white, or light colored background to improve readability.

Startup

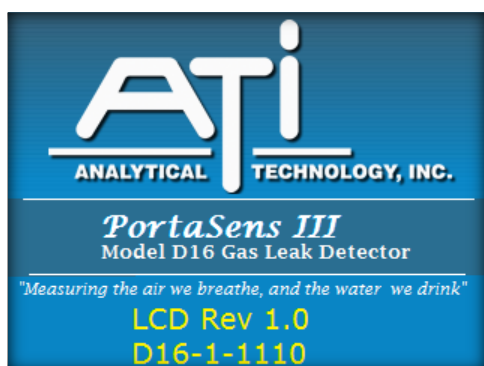

Install a gas sensor module as described in Sensor on page 30, connect the sampling wand to the inlet port of the manifold (Figure 2 on page 5), and hold the “Wakeup” switch down for one second. When the D16 starts, it displays the pages shown below.

LCD and CPU revision levels and serial number. Times out after four seconds. Swipe down to advance without waiting (image will not match your device).

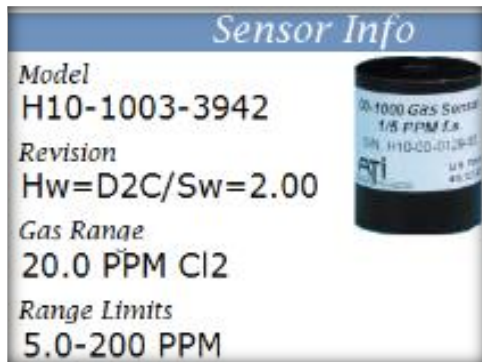

Information about the currently installed sensor. Times out in four seconds. Swipe down to advance without waiting (image will not match your device)

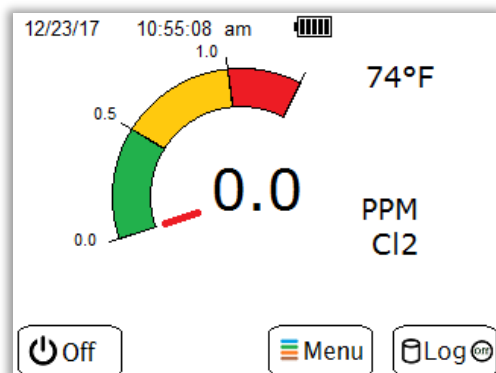

Main operational display, presents the gas level reading, gas temperature, alarm indicators, battery and pump status, date, and time (example only).

Figure 10 D16 startup displays.

If the D16 and H10 sensor are functioning normally, the “Main Display” is visible. Verify the pump is running and drawing air into the inlet port. If a problem is detected, the pump motor remains off and a trouble alarm appears (if this is the case, see Troubles and Exceptions on page 54).

Shutdown

To turn the D16 off, touch the “Off” button when it appears on the display, or hold the “Wakeup” switch down for one second (see Figure 3, page 6).

Main Display

The “Main Display” is the primary display page, and the D16 will normally revert back to it when left untouched for a period of time. It presents the most important information and indications, which are identified in the example shown in Figure 11 below, and described in the sections that follow.

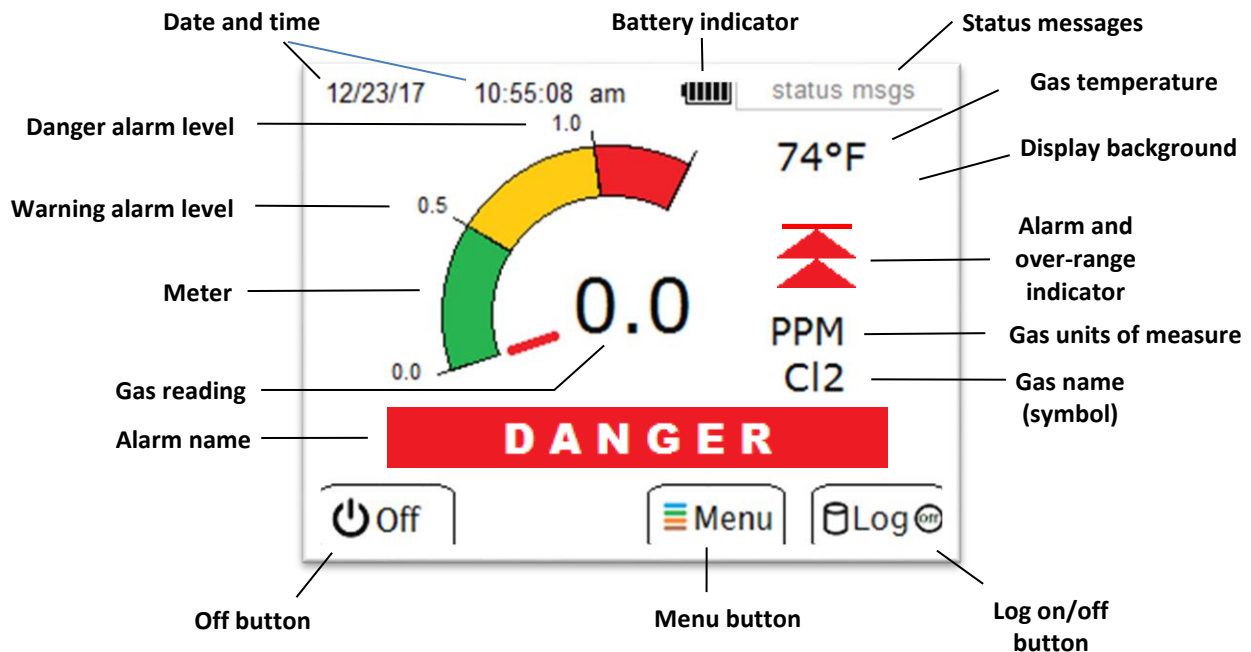

Figure 11 Main Display page indications (example)

Gas Reading, Units, Name, and Temperature

The gas concentration reading appears at the center of the display in a large, easy to read font, along with the chemical name, units of measure, and gas temperature. The gas name and units of measure are fixed, based on the design of the sensor.

Settings in the sensor memory affect the behavior of the gas reading. In particular, the sensor’s full scale range setting, *Range*, controls the maximum displayed value and determines the resolution of the reading, as shown in Table 1 (below). The gas reading will report up to 120% of the *maximum* range of the sensor, regardless of the programmed full scale range. *Averaging* is used to

stabilize the reading when necessary, and *Blanking* is used to suppress small reading fluctuations near zero, and negative readings below zero. See Sensor on page 30 for details about the operation and configuration of these settings.

Table 1 Gas reading resolution.

<i>Range</i>	<i>Resolution</i>
0.00 to 4.99	0.01
5.0 to 49.9	0.1
50 and above	1



The gas temperature reading is derived from the H10 sensor and is used to correct the gas reading of oxygen sensors. By default, temperature is displayed in units of °F, but may be changed to °C (see Temperature Units on page 17).

Gas Alarm Indicators

The D16 features three gas “level” alarms designated as *Danger*, *Warning*, and *Caution*, which are indicated on the Main Display, *only*.

When a gas level alarm occurs, the beeper sounds and the alarm name and indicator blink on and off. Touching the display silences the beeper and causes the name and indicator to remain on steady until the alarm condition subsides. The table below summarizes the alarm indications on the Main Display. See Alarms on page 21 for details about the operation and configuration of alarms.

Table 2 Alarm indicators.

<i>Alarm Name</i>	<i>Priority (ranking)</i>	<i>Indicator</i>
DANGER (RED)	Highest	 Alarm type = “HIGH” Alarm type = “LOW”
WARNING (YELLOW)	Middle (not displayed when danger alarm is active)	 Alarm type = “HIGH” Alarm type = “LOW”
CAUTION (BLUE)	Lowest (not displayed when danger or warning alarm is active)	 Alarm type = “HIGH” Alarm type = “LOW”







Meter

The meter is presented in one of two styles to indicate the gas reading, “Normal”, and “% FS”. The “Normal” style divides it into three colored bands, based on the alarm settings. The “% FS” style indicates only the sensor full scale range, ½ full scale range, and 0. This is designed for applications not intended to have alarms. See Meter in Display Operation on page 16 for details about the meter operation and configuration.

Battery Indicator

The battery indicator displays the voltage of the battery, which can be used to approximate the level of charge remaining.

Table 3 Battery indications.

<i>Indication</i>	<i>Description</i>	<i>Hours Remaining* (NiMH)</i>
	Bat \geq 1.25v	10 - 11
	Bat=1.20-1.24v	
	Bat=1.15-1.19v	5 - 6
	Bat=1.10-1.14v	
	Bat=1.05-1.09 Low	
	Bat<1.05	Shutdown imminent
	Device powered by USB connection (battery disabled)	

**Starting from fully charged state, as instructed by the supplied (optional) charger.*

Status Messages

Battery and pump status messages listed in Table 4 appear once every 2 seconds.

Table 4 Main display status messages.

<i>Message</i>	<i>Description</i>
BATTERY LOW	Battery life down to one bar
NO BATTERY	Battery removed (only appears in normal operation running on USB power)
CHECK FLOW	Sampling wand or pump restricted
PUMP OFF	Pump motor disabled via configuration setting
NO PUMP	Pump motor enabled but pump current not detected

Date and Time

The local calendar date and time is presented in the upper left corner. See Date and Time on page 44.

Display Background

The background of the “Main Display” may be set to improve visibility (see Main Display Appearance on page 16).

Buttons

Buttons displayed along the bottom of the display are touch-sensitive, and have the following purpose.

Off

Touching the “Off” button places the D16 into a low power shutdown mode. The H10 sensor remains powered on, but the CPU and LCD display are disabled. Holding the “Wakeup” switch down for one second, or replacing the battery, will restart the D16.

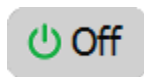

Menu

The “Menu” button is the entry point for accessing configuration settings, other operating modes.

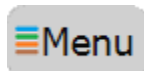

Log

The “Log” button toggles the data logger on and off, as indicated by the presence of a red “dot” appearing on the button face. Data logging is off at startup, and when toggled on, will record samples based on its current configuration. See Data Log on page 24.



- a) Data logger off 
- b) Data logger on 

Figure 12 Data log control button

Main Menu

The “Main Menu” appears by touching the “Menu” button on the “Main Display”. It is the starting point for changing settings and selecting other operating modes.

D16 menu backgrounds are dark, but appear light throughout this manual to improve readability.

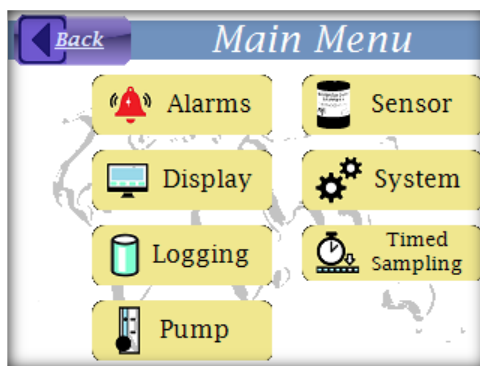

Display

The display settings are described below and accessed via the menu system as detailed in Configuring the Display on page 18.

Brightness

When the D16 starts, brightness is set to a default level and may be adjusted on any page by swiping a finger across the display, left-to-right to increase brightness, or right-to-left to decrease brightness. The new value may be permanently saved as the default brightness setting (see Configuring the Display on page 18).

Figure 13 Adjusting brightness by swiping.

Increasing the display brightness will reduce battery life. However, to save power, it is not recommended to decrease the display brightness to the extent that the display is unreadable. Instead, the D16 can operate in “Sleep” mode with the display completely unpowered to dramatically conserve battery life (see Sleep Mode on page 17).

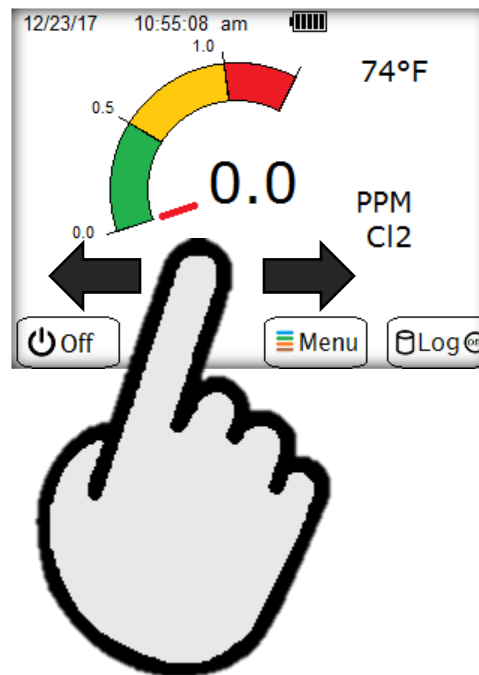

Main Display Appearance

The “Main Display” is the primary page viewed during normal operation and has the properties described below.

Background

The background of the “Main Display” may be set to “Dark” for better indoor and nighttime readability, or to “Light”, to improve daylight visibility.

Meter

The meter indicates the gas reading and is presented in one of two styles. The “Normal” meter style features three color bands to indicate the reading’s proximity to the “Warning” and “Danger” alarm levels (“Caution alarm is normally used to indicate excessive sensor drift and is not represented). The other meter style is “% FS”, which presents the full scale range of the sensor (“Range”).

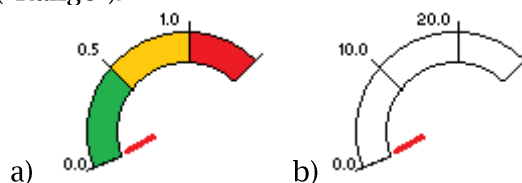

Figure 14 Meter styles - Normal (a), and % FS (b).

To enable the “Normal” meter display, the alarm *types* and *levels* must conform to one of the rules listed in Table 5. Otherwise, the “% FS” meter style will be presented.

Table 5 Alarm setting rules for “Normal” meter presentation.

	Rules	Comments
1	<p>Danger Alarm Type = High and Warning Alarm Type = High and Danger Alarm Level > Warning Alarm Level</p>	Typical of toxic gas sensors.
2	<p>Danger Alarm Type = Low and Warning Alarm Type = Low and Danger Alarm Level < Warning Alarm Level</p>	Typical of oxygen sensors.

If the meter style is set to “Normal”, but neither alarm setting rule applies, the “% FS” meter style is used.

Temperature Units

The gas temperature is displayed in units of °F, but may be changed to °C.

Menu Timeout

The “Main Display” page is the primary display used during normal operation, and the D16 automatically returns to it when left “untouched” for a defined period of time.

Sleep Mode

To conserve battery life, the display may be de-powered during normal operation, without disabling the critical leak-detection functions. The D16 will continue to sample, generate readings, and log data – without the display powered on, which will normally have a significant effect on the operational time. The display is repowered when one of the following occurs.

1. Gas level alarm
2. CPU trouble (see Trouble on page 54)
3. “Wakeup” switch press
4. Power interruption (battery removed and reinstalled)
5. USB connected to, or disconnected from, a host or charger

This mode of operation should not be used when alarms are disabled.

Troubles

Critical problems are indicated immediately upon detection by the appearance of the “Trouble Display”. When it appears, the only recourse is to correct the problem, or touch the “Off” button. See Troubles and Exceptions on page 54 for a list of corrective actions.

Configuring the Display

Table 6 Configuring the display.

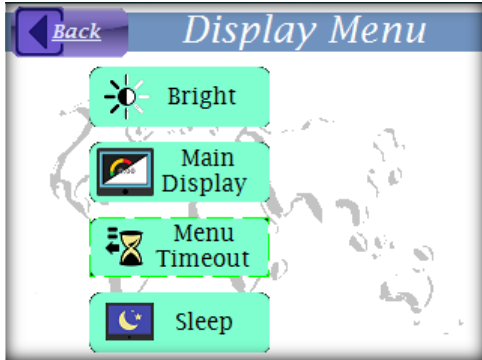
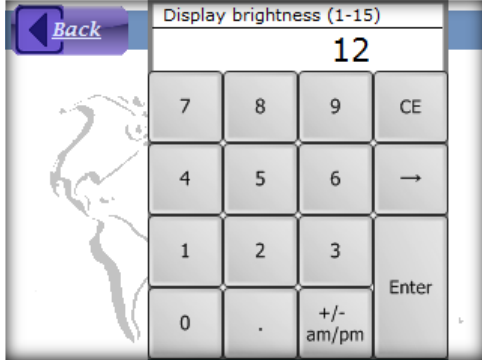
<i>Description</i>	<i>Display</i>
<p>Display Menu</p> <p>On the “Main Display” page, touch the “Menu” button, and then touch the “Display” button. This will present the “Display Menu” page, as shown on the right.</p>	
<p>Display Brightness</p> <p>On the “Display Menu” page, touch the “Bright” button. The numeric keypad control will appear and display the current value, as shown on the right. The value represents the default brightness – <i>only if it has not been adjusted by swiping</i>. It is suggested to adjust the brightness by swiping before entry, then save the new value by touching “Ok” button. Touch the “Back” button to close the control and return without saving.</p> <p>Setting range: 1(dark) - 15 (light)</p>	

Description**Display****Main Display Background**

On the “Display Menu” page, touch the “Main Display” button, and then touch the “Back-Color” button. The “spin” edit control will appear and display the current value, as shown on the right. Touch the up or down arrow to change the setting, then touch the “Ok” button to save it. Touch the “Back” button to close the control and return without saving.

Setting range:

- **Dark** – (default) better for indoor and night use.
- **Light** – better for outdoor use

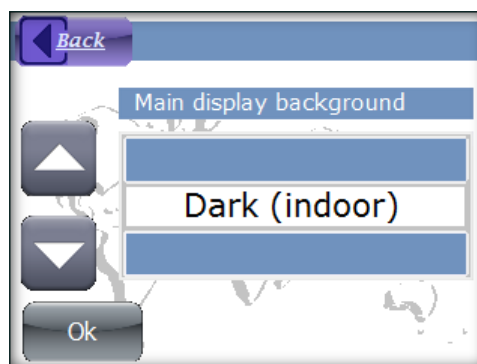
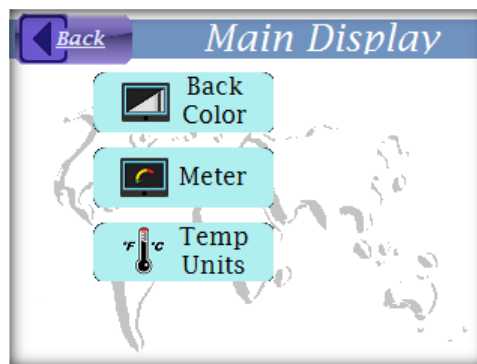
**Main Display Meter**

On the “Display Menu” page, touch the “Main Display” button, and then touch the “Meter” button. The “spin” edit control will appear and display the current value, as shown on the right. Touch the up or down arrow to change the setting, then touch the “Ok” button to save it. Touch the “Back” button to close the control and return without saving.

Setting range:

- **Normal** – (default) three-colored style showing the Danger and Warning alarm levels (when allowed by alarm settings).
- **% FS** – simple style presenting the full scale range, ½ full scale range, and 0.

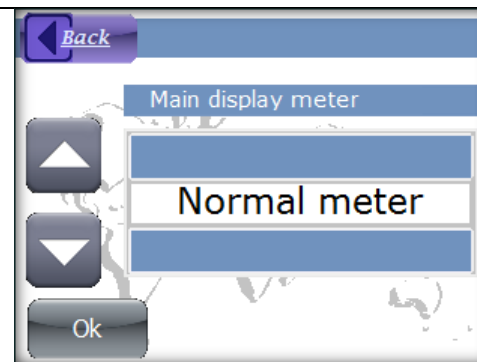

Description**Display****Main Display Temp Units**

On the "Display Menu" page, touch the "Main Display" button, and then touch the "Temp Units" button. The "spin" edit control will appear and display the current value, as shown on the right. Touch the up or down arrow to change the setting, then touch the "Ok" button to save it. Touch the "Back" button to close the control and return without saving.

Setting range:

- °F
- °C

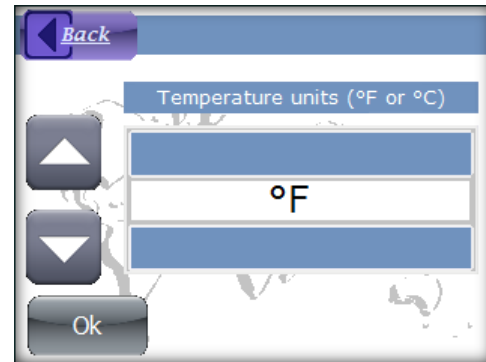
**Menu Timeout**

On the "Display Menu" page, touch the "Menu Timeout" button. The numeric keypad control will appear and display the current value, as shown on the right. Use the keypad to enter the new value, then touch the "Ok" button to save it. Touch the "Back" button to close the control and return without saving.

Setting range: 1-60 minutes

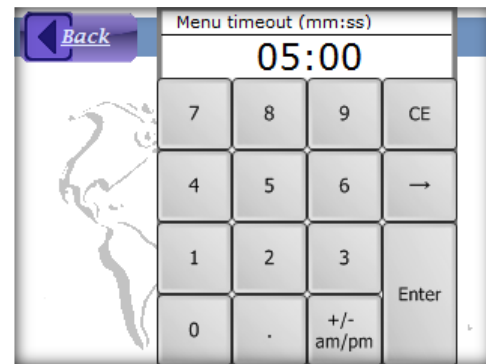
**Sleep**

On the "Display Menu" page, touch the "Sleep" button. If there are no gas level alarms active, the display will turn off, but the D16 will continue to function.

Setting range:

- Wake on alarm
- No wake on alm

If "Wake on alarm" is selected, and an alarm is active, an exception message will be displayed.

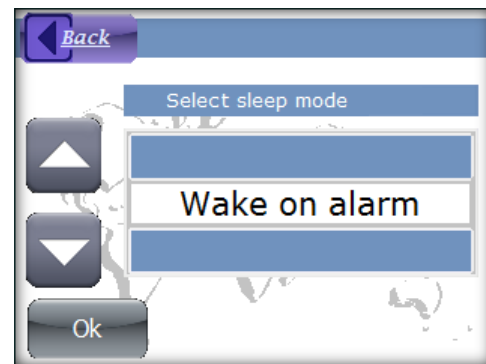

Alarms

The D16 features three gas level alarms designated as *Danger*, *Warning*, and *Caution*, which are indicated on the “Main Display” when they become active.

A gas level alarm occurs when the measured gas reading equals or exceeds an alarm’s level setting. Only one of the three gas level alarms appears at a time, based on priority (ranking). “Danger” is the highest priority, followed by “Warning”, and then “Caution”. The priority is fixed, and only the alarm with the highest priority is indicated. This is done to avoid potentially confusing, multiple alarm indications.

Table 7 Gas level alarms.

<i>Alarm</i>	<i>Priority (Ranking)</i>
Danger Alarm	Highest
Warning Alarm	Middle
Caution Alarm	Lowest

The behavior of each alarm is controlled by its *Type* setting, and is programmable as “High”, “Low”, or “Disabled”. A “High” alarm is active when the gas reading is “at or above” the programmed alarm level and is used to indicate an excess of toxic, or otherwise dangerous, gas. A “Low” alarm is active when the gas reading is “at or below” the programmed alarm level. It is used primarily to indicate oxygen deficiency, and also used to indicate when a sensor may have drifted significantly below zero. A “Disabled” alarm remains disabled until changed by user. Table 8 below summarizes the alarm behavior.

Table 8 Gas alarm types.

<i>Alarm Type</i>	<i>Description</i>
High	Gas reading at or above the alarm level setting
Low	Gas reading at or below the alarm level setting
Disabled	Alarm permanently disabled

Alarm types and levels are sensor specific and programmed into the sensor memory. They are read at startup, and when a sensor is installed. They may be changed or permanently disabled; however, care must be taken, since it could lead to unsafe or confusing indications on the “Main Display”. A description of each alarm follows.

The following descriptions apply to the default settings.

Danger Alarm

Toxic gas sensors: Danger is normally a “high-high” alarm, set approximately 2–3 times higher than the Warning level, and becomes active at, or above, this level.

Oxygen sensors: Alarm is normally a “low-low” alarm, and its level is set to 16% O₂, and the alarm becomes active at, or below, this level.

Warning Alarm

Toxic gas sensors: Warning is normally a “high” (rising) alarm and its level is set to the TLV (threshold limit value) of the gas. The alarm becomes active when the gas concentration reading is *at or above* this level.

Oxygen sensors: Warning is normally a “low” (falling) alarm and its level is set to 19.5%. The alarm becomes active when the gas concentration reading is *at or below* this level.

Caution Alarm

Toxic gas sensors: Caution is normally a low (falling) alarm, and its level is set to -10% of the full scale range. This is intended to indicate *excessive* negative sensor drift, a condition which should be corrected by zeroing. The alarm becomes active when the gas concentration reading is *at or below* this level for 2 seconds.

Oxygen sensors: Caution is normally a high (rising) alarm and the level is set to 23% O₂. It is intended to indicate an uncommon condition that should be corrected, if it persists. Note that it is normal for an O₂ sensor to produce a high reading when left, “off bias” (unpowered), for more than a few minutes.

Configuring Alarms

The three gas level alarms are configured using Table 9 below.

Table 9 Configuring alarms.

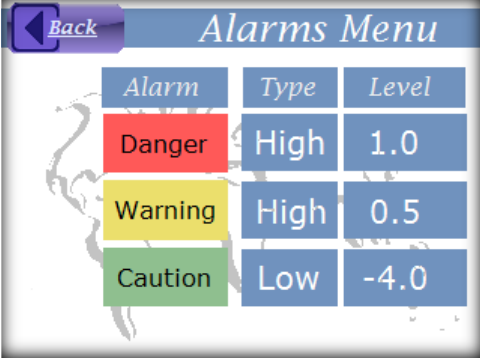
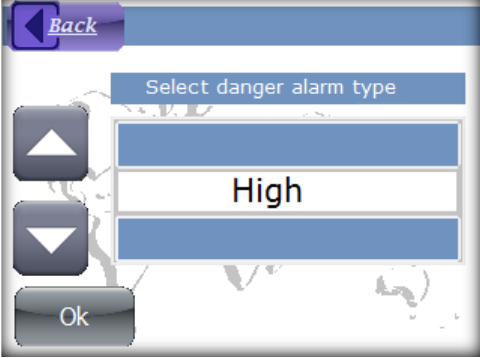
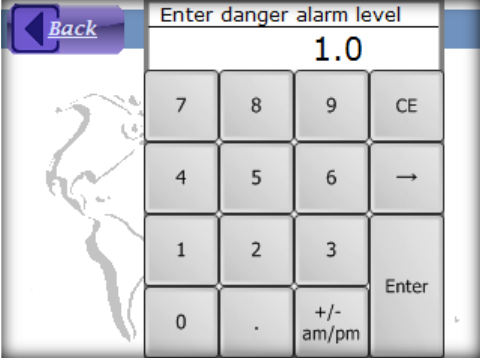
Description	Display												
<p>Alarms Menu</p> <p>On the "Main Display" page, touch the "Menu" button, and then touch the "Alarms" button. This will present the "Alarms Menu" page, as shown on the right.</p> <p>The three alarms appear from top to bottom as rows in a table. The name of the alarm appears in the first column, the alarm's "Type" setting is in the second column, and the alarm's "Level" setting is in the third column.</p>	 <table border="1" data-bbox="992 428 1469 783"> <thead> <tr> <th>Alarm</th> <th>Type</th> <th>Level</th> </tr> </thead> <tbody> <tr> <td>Danger</td> <td>High</td> <td>1.0</td> </tr> <tr> <td>Warning</td> <td>High</td> <td>0.5</td> </tr> <tr> <td>Caution</td> <td>Low</td> <td>-4.0</td> </tr> </tbody> </table>	Alarm	Type	Level	Danger	High	1.0	Warning	High	0.5	Caution	Low	-4.0
Alarm	Type	Level											
Danger	High	1.0											
Warning	High	0.5											
Caution	Low	-4.0											
<p>Alarm Type</p> <p>On the "Alarms Menu" page, touch the setting value in the "Type" column, in the alarm's row. A "spin" edit control will appear and display the current value, as shown on the right. Touch the up or down arrow to change the setting, then touch the "Ok" button to save it. Touch the "Back" button to close the control and return without saving. The value may be set to one of the following.</p> <ul style="list-style-type: none"> • High – active at or above the "Level" setting • Low = active at or below the "Level" setting • Off = alarm disabled 													
<p>Alarm Level</p> <p>On the "Alarms Menu" page, touch the setting value in the "Level" column, in the alarm's row. The numeric keypad control will appear and display the current value, as shown on the right. Use the keypad to enter the new value, then touch the "Ok" button to save it. Touch the "Back" button to close the control and return without saving.</p> <p>Setting range: -20% full scale range ("Range") to 120% of the upper range limit. The upper range limit is displayed on the "Sensor Information" page (see Figure 19 on page 30).</p> <p>Warning: Alarm levels do change when the sensor full scale range is changed. Care should be taken to ensure alarm levels are not configured above the full scale range of the sensor.</p>													

Data Log

The data logger records time-stamped gas readings into “.csv” text files, which may be viewed with a simple text editor like *Microsoft Notepad*, and *Microsoft Excel*.

To start recording, touch the “Log” button on the “Main Display” (see Main Display on page 11) and wait for the red indicator to appear on the button. To stop recording, touch the “Log” button again. Any of the following actions will stop the data logger.

1. Touching the “Log” button while logging (red dot visible on button)
 2. Touching the “Off” button
 3. Pressing the “Wakeup” button
 4. Allowing the battery to run down below 1 bar
 5. Removing the sensor*
 6. Removing the battery*
- *Stop the data logger before removing the sensor or the battery.

Make certain to set the D16 date and time. See Configuring the Data Logger on page 27 to configure the interval for the data logger.

Gas readings are time stamped, set the correct date and time before starting the data logger.

USB Mode

Connecting the D16 to a USB host presents the display shown in Figure 15, and data may be transferred to the host. Touching the “Exit” button will cancel the USB data connection and restart the D16 in normal operating mode. While powered from the USB connection, battery power is not required, and the battery may even be removed.



Figure 15 USB mode display.

Directory Structure

Logged gas readings are stored in files and are accessible over the USB data connection using a file browser like *Microsoft File Explorer*. The files are maintained in a calendar based directory structure to make them easy to find. The year directory is at the top, and log files appear in the month directories below it. Filenames are simply the day of the month on which a collection of samples were taken, with a .csv extension. Changing the date after logging has been started will change the file where readings are placed. Be sure to set the correct date and time, if necessary, before starting the data logger.

The example in Figure 16 illustrates how 7 files created in month 10 (October) of 2017 might appear.

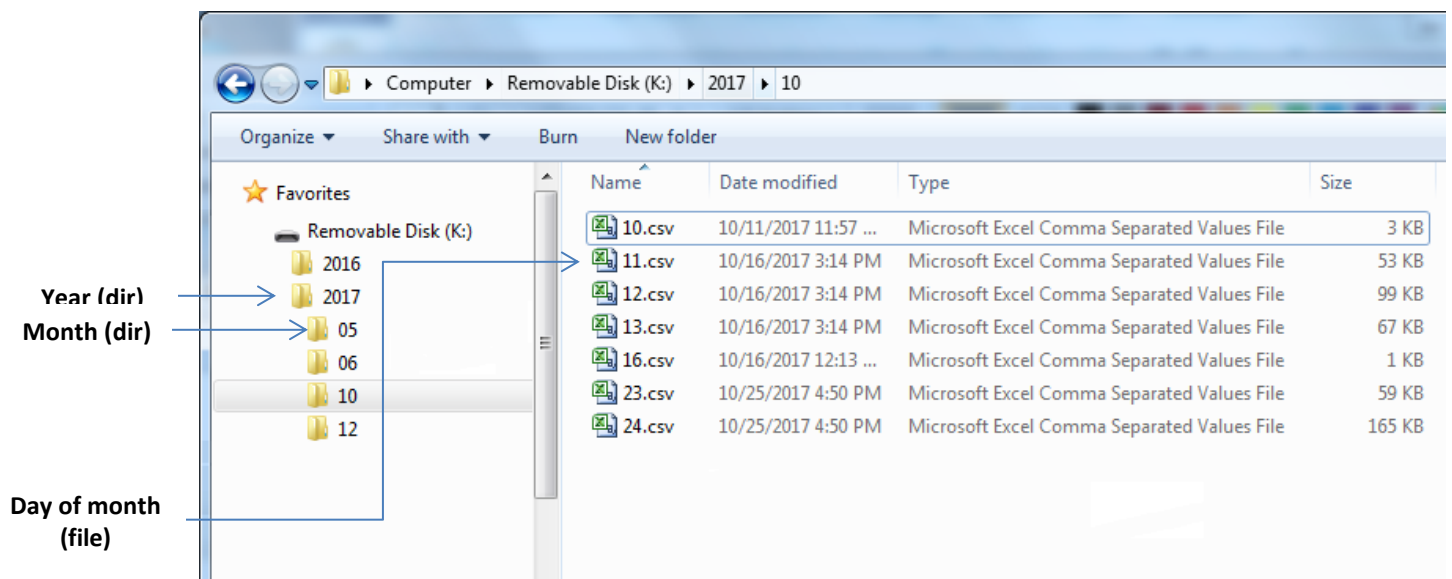

Figure 16 Data logger file structure.

File Structure

A data log file is a collection of readings recorded in a single day. They are ordered in time, from top to bottom, and grouped into sessions. A session begins when data logging is started, and ends when it is stopped. A sensor information header always precedes the gas readings. Since the header includes the “Range” of the sensor, changing this setting while logging will create a new sensor information header.

Figure 7 below is an example of a data log file opened directly with *Microsoft Excel*.

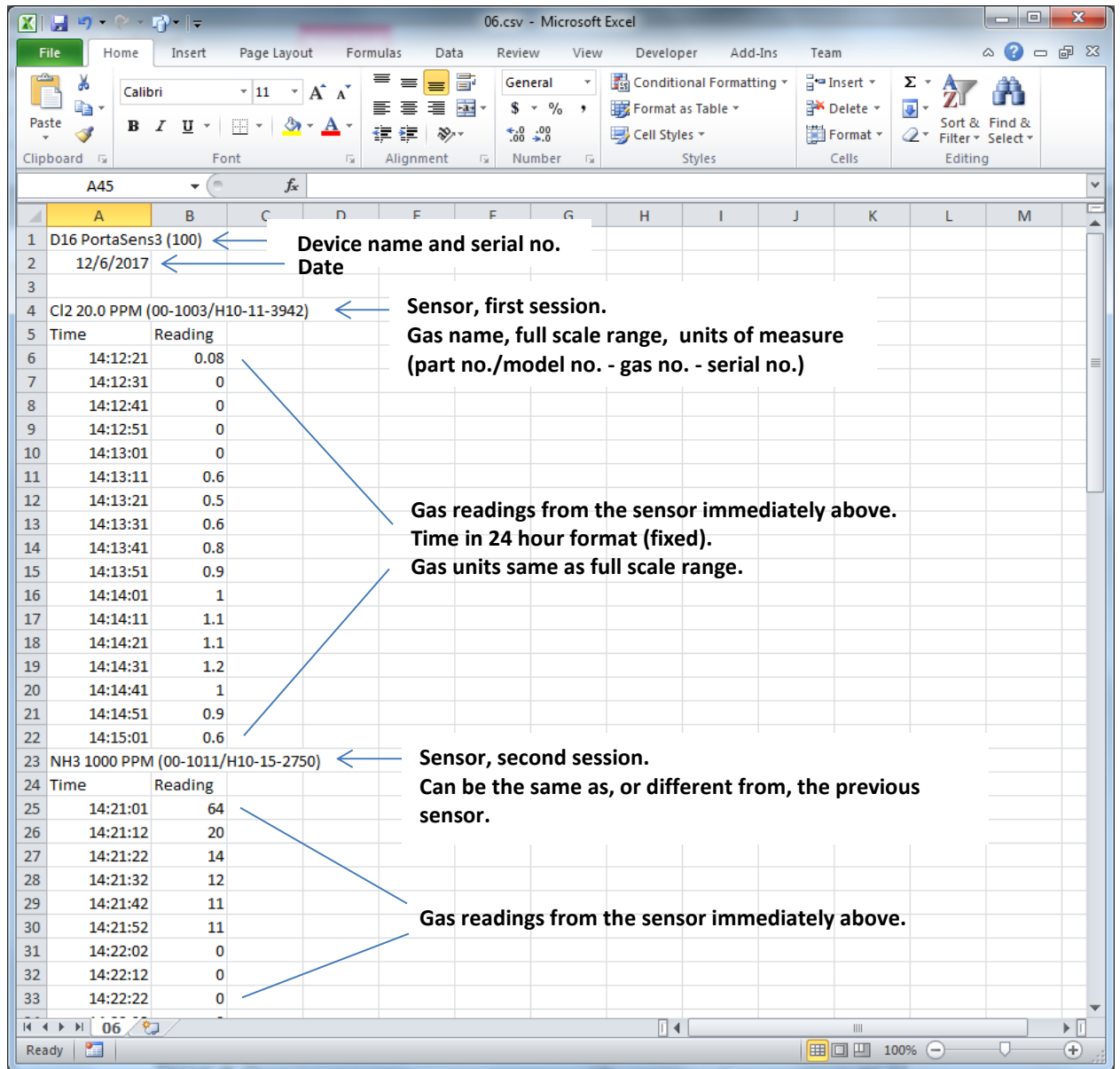
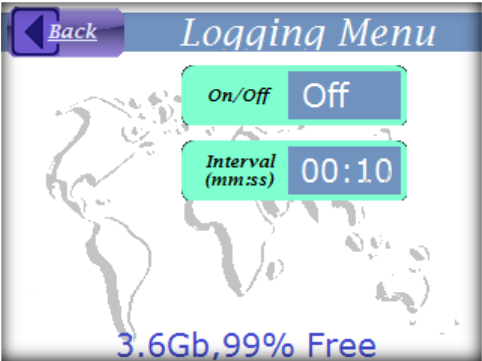
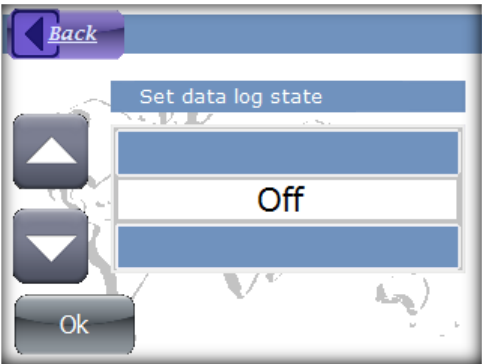
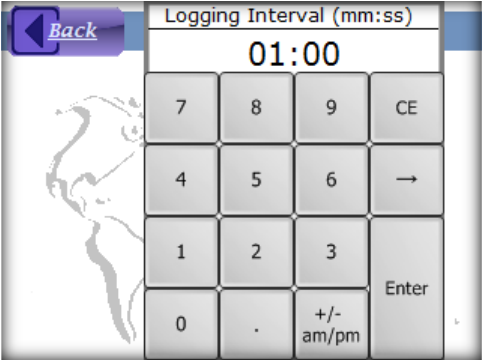

Figure 17 Example data log file opened with Microsoft Excel.

Configuring the Data Logger

Table 10 Configuring the data logger.

<i>Description</i>	<i>Display</i>
<p>Logging Menu</p> <p>On the “Main Display” page, touch the “Menu” button, and then touch the “Logging” button. This will present the “Logging Menu” page, as shown on the right.</p>	
<p>Data Logger On/Off</p> <p>On the “Logging Menu” page, touch the “On/Off” button. The “spin” edit control will appear and display the current value, as shown on the right. Touch the up or down arrow to change the setting, then touch the “Ok” button to save it. Touch the “Back” button to close the control and return without saving. The value may be set to one of the following.</p> <ul style="list-style-type: none"> • On – starts data logging • Off – stops data logging • Clear – clears data from the current day. 	
<p>Data Logging Interval</p> <p>On the “Logging Menu” page, touch the “Interval” button. The numeric keypad control will appear and display the current value, as shown on the right. Use the keypad to enter the new value, then touch the “Ok” button to save it. Touch the “Back” button to close the control and return without saving.</p> <p>Setting range: 10 sec to 1 hr (default=1 min)</p>	

Pump

The D16 pump draws gas to the sensor through the inlet port. The pump is connected to a DC motor whose speed is controlled by the “duty cycle” of a PWM (pulse-width-modulated) signal. The duty cycle is proportional to the motor speed and is preset at the factory for a flowrate of 400cc/min (0.85 SCFH), and can be adjusted.

The pump motor momentarily runs fast when it starts. This speeds up delivery of gas to the sensor, and helps to insure the motor starts when cold. A blockage of the inlet or outlet port also causes the pump motor to speed up. The pump will not usually be damaged by operating with a blockage for a short time, but doing so will increase the transport time of gas to the sensor, and will also decrease the battery life.

A flow meter is included in the accessory kit to verify the flow rate. To use it, connect the sampling wand and push the flow meter’s tubing adapter onto the tip. Hold the D16 so the meter is vertical, and verify the flow rate is 250 - 400 cc/min. If required, adjust the “Duty Cycle” setting in the “Pump” configuration menu (below).

Proper flow should be verified before use.

Pump Status

When a blockage occurs, the D16 beeps once and displays, “CHECK FLOW”, in upper right corner of the Main Display. See Pump Troubles on page 55 for further details about corrective actions for pump problems.

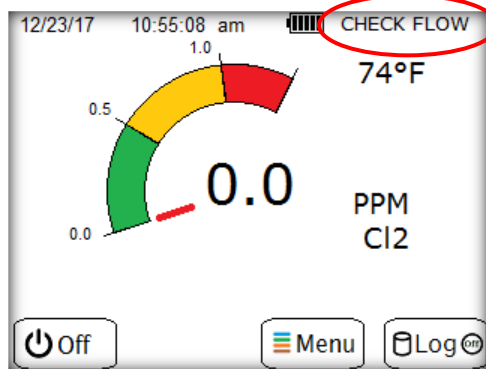
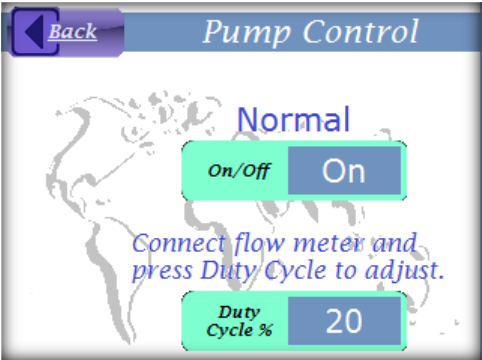
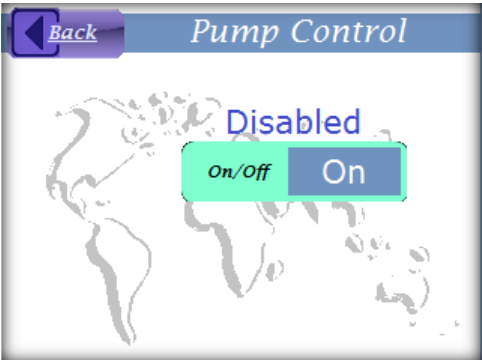
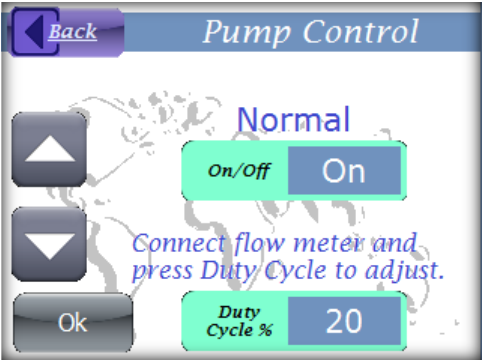

Figure 18 Pump status on “Main Display”.

The pump stops running when the sensor is removed, and when the trouble alarm is active (“Trouble” page is visible). The pump motor may be disabled for diffusion mode sampling. When this occurs, “PUMP OFF” appears in the upper right corner of the “Main Display”.

Configuring the Pump

Table 11 Configuring the pump.

<i>Description</i>	<i>Display</i>
<p>Pump Control Page</p> <p>On the “Main Display” page, touch the “Menu” button, and then touch the “Pump” button. This will present the “Pump Control” page, as shown on the right.</p> <p>The page presents the current pump status:</p> <p>Normal (or Restricted) – the pump will operate at startup, and will maintain 400cc/min (0.85 SCFH).</p> <p>Disabled – the pump does not run, even after the D16 is restarted.</p>	
<p>Pump On/Off (Toggle)</p> <p>On the “Pump Control” page, touch the “On/Off” button. If the pump status was “Normal”, it will be changed to “Disabled”. Otherwise, the control will be changed back to “Normal”.</p>	
<p>Pump Duty Cycle</p> <p>On the “Pump Control” page, touch the “Duty Cycle %” button and adjust the pump motor speed up or down to achieve the desired flow rate.</p> <p>Setting range: 1-100 %</p>	

Sensor

As described in the Introduction, the D16 quickly adapts to measure different gasses by inserting an appropriate H10 gas sensor module. The module retains all of the calibration and configuration settings for the target gas, such as the chemical name, units of measure, full scale “range”, “blanking”, “averaging”, and the gas level alarm settings. The H10 module also stores a history of the last 63 zero and span calibrations, which the D16 presents on the display.

When an H10 sensor is installed, the D16 presents a “Sensor Information” page, as shown in Figure 19 below. This occurs at startup, and when a sensor is installed, and also on timeout from the “Main Menu”. The page also appears by touching the “Info” button on the “Sensor Menu” page. The D16 will display a trouble alarm whenever the sensor is removed, and will *automatically turn power off after 5 minutes*. See Trouble Messages on page 54.

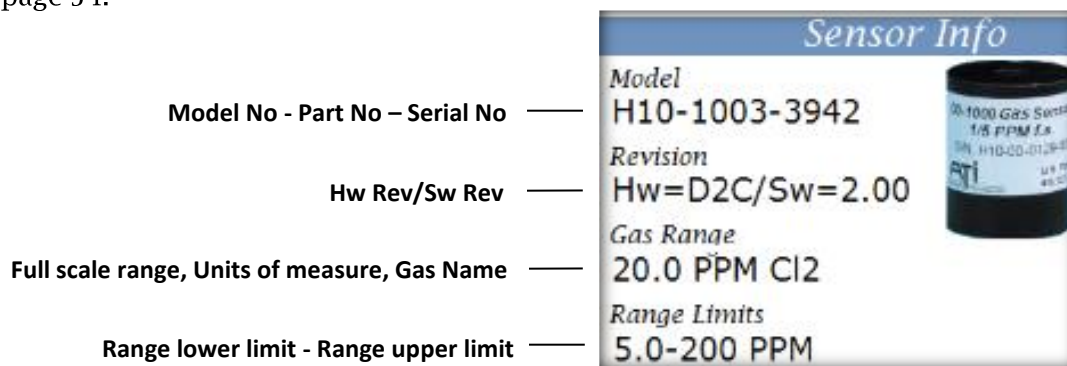

Figure 19 Sensor Information page.

Gas readings are affected by three configuration settings stored in the H10 sensor memory: “Range”, “Blanking”, and “Averaging”, which are described below. Details on changing these settings follow in Configuring the Sensor on page 32. Settings for the gas level alarms are covered in Alarms on page 21.

Range

“Range” is the upper range value and determines the 100% full scale reading of the D16 (0 is always the lower range value). The setting does not limit the displayed reading¹, but does limit the alarm levels and blanking value (below). It is also used for computing the “Timed Sampling” recovery set point. The setting is stored in the H10 sensor memory so that every device using it is configured with the same value².

The “Range” setting also determines the resolution of the displayed gas reading. Table 12 below details how the device uses it to configure the best reading resolution possible.

Table 12 Gas reading resolution.

<i>Range</i>	<i>Resolution</i>
0.00 to 4.99	0.01
5.0 to 49.9	0.1
50 and above	1

Normally, the range setting is set to the highest exposure level expected. Limits for the setting vary by sensor and are displayed on the “Sensor Information” page, shown in Figure 19 on page 30.

Blanking

“Blanking” refers to the method by which the device suppresses small reading fluctuations near zero. It works by forcing the displayed reading to 0 when it is at, or below, the “Blanking” setting. This also suppresses negative readings, which occur when the cell output current drifts below its last zero calibration. “Un-blanked” readings are not suppressed and are displayed during sensor calibration.

The blanking value is expressed in the units of measure of the target gas (ie, PPM). It is normally 2% of the range, and adjustable up to 10%. When “Range” is changed, the blanking value is changed proportionally. For example, the blanking value for a 1000 PPM Ammonia sensor is normally set to 10 PPM. If the range is changed to 2000 PPM, the blanking value is changed to 20 PPM.

¹ Range and readings are restricted by the maximum range of the sensor, displayed on the “Sensor Information” page.

² Except D12 and F12 gas transmitters (see H10 Sensors and D12 or F12 Transmitters on page 48).

Averaging

The gas concentration reading is computed 5 times per second and is digitally “damped” by the D16 to suppress noise. Damping is controlled by the “Averaging” setting, a value that ranges from 1 to 100, and represents the number of seconds required to achieve approximately 95% of the final value *after* the sensor output changes. The default is normally 5–15, but varies depending on the sensitivity³ of the sensor. More damping may be temporarily required while viewing the “un-blanked” gas reading during calibration.

Configuring the Sensor

Table 13 Configuring the sensor.

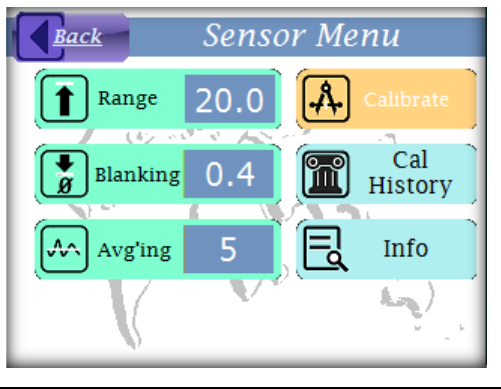
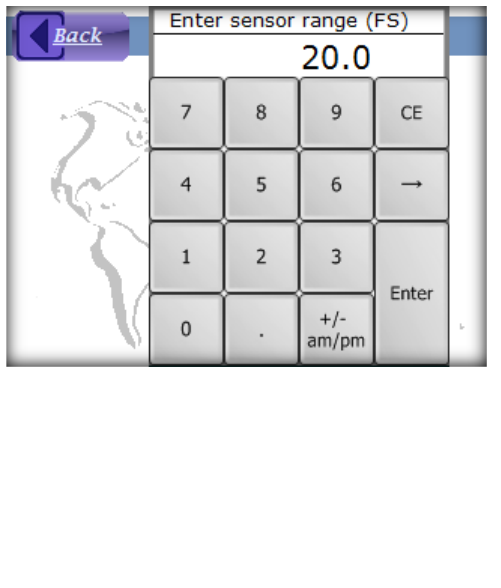
Description	Display
<p>Sensor Menu Page</p> <p>On the “Main Display” page, touch the “Menu” button, and then touch the “Sensor” button. This will present the “Sensor Menu” page, as shown on the right.</p>	
<p>Range</p> <p>On the “Sensor Menu” page, touch the “Range” button. The numeric keypad control will appear and display the current value, as shown on the right. Use the keypad to enter the new value, and then touch the “Ok” button to save it. Touch the “Back” button to close the control and return without saving.</p> <p>Setting range: “Range” may be set from the lower to the upper limit, which appears on the “Sensor Info” page (see below).</p> <p>Warning: Alarm levels do change when the sensor full scale range is changed. Care should be taken to ensure alarm levels are not configured above the full scale range of the sensor.</p>	

³ Usually expressed as output current per unit of gas exposure, ie, “uA/PPM”.

Description

Display

Blanking

On the “Sensor Menu” page, touch the “Blanking” button. The numeric keypad control will appear and display the current value, as shown on the right. Use the keypad to enter the new value, and then touch the “Ok” button to save it. Touch the “Back” button to close the control and return without saving.

Setting range: The blanking value appears in the sensor’s units of measure (ie, PPM) and may be set from 0 to 10 % of the “Range” value. Changing the “Range” value changes the blanking value proportionally.

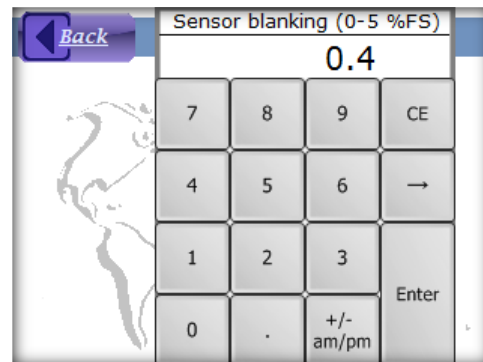

Averaging

On the “Sensor Menu” page, touch the “Averaging” button. The numeric keypad control will appear and display the current value, as shown on the right. Use the keypad to enter the new value, and then touch the “Ok” button to save it. Touch the “Back” button to close the control and return without saving.

Setting range: 1-100 (approximately the time in seconds to reach T95)

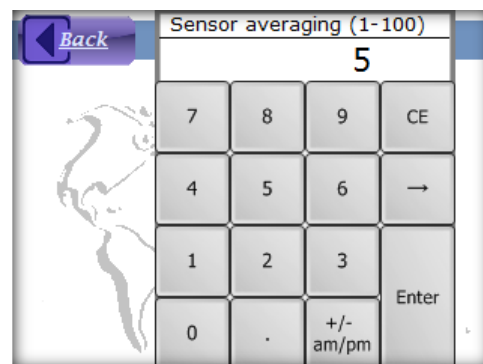

Calibration

Sensor calibration is a two-step procedure known as “Zero” and “Span” that records gas response data in the sensor memory. The D16 reads the data and uses it to generate accurate gas readings.

“Zero” is the term applied to the sensor output in the absence of the target (or surrogate⁴) gas. Over time, the sensor zero output may decrease, resulting in a slightly negative gas concentration reading. Zero calibration solves this problem by storing the cell’s zero output level in sensor memory, and subtracting it out when computing the gas reading. Zero calibration is recommended to be performed, or checked, once every 2–3 months, and should always be done before “Span” calibration.

“Span” is the term applied to the sensor output in the presence of the target (or surrogate) gas. The output level, divided by the concentration of gas applied, is the sensor’s “sensitivity”. Over time, changes in cell chemistry or diffusion may cause the sensitivity to decrease, causing the D16 to produce readings lower than actual. Span calibration updates the sensitivity value in memory, which is then used when computing the gas reading.

Span calibration is recommended to be performed, or checked, once every 6 months. This period may be extended to one year if the sensor is used infrequently, and stored appropriately. The concentration of the source gas is normally between the “Warning” and “Danger” alarm levels for toxic gas sensors, and 20.9 % for Oxygen sensors (normal atmospheric concentration).

“Zero” must be done before “Span”.

Factory Calibration Services

Sensors may be returned to the factory for calibration, where they are calibrated using specialized gas cylinders, blenders, generators, and other traceable standards that might not be available to most users (most typically for span calibration). These standards tend to be expensive to acquire and maintain, which might make factory calibration more economical in the long run. Contact the factory, or your factory representative, for details on the certified calibration program for H10 sensors.

⁴ Gas used in place of the sensor’s target gas as a matter of convenience or safety, to which the sensor is usually more or less sensitive.

Owner Calibrations

Owners who wish to perform, or verify, the sensor's calibration should have the appropriate, traceable gas standard(s) to use for the zero and span calibration methods below. Atmospheric air may be used for zero calibration, if it is known with certainty to be free of the target and interference gases. Note that indoor Carbon dioxide levels may be higher in winter, when doors and windows are closed. Levels of Carbon monoxide (CO), oxides of nitrogen, and ozone may be higher in summer, due to smog. When in doubt, use bottled zero air, or Nitrogen (required for O₂ sensors), when performing this procedure.

Pressurized Gas Sources

Supplying gas to the device from a pressurized source requires a bypass-T to be inserted between the source and the manifold (Figure 20 below). This is required to limit gas pressure on the intake side of the sample pump when the source is open, and prevent the inlet from being blocked when the source is closed. The flow rate into the T must exceed the pump flow rate of 400cc/minute (0.85 SCFH), or the calibration gas may become diluted. A flow rate of 500 cc/min (1.06 SCFH) into the T is recommended.

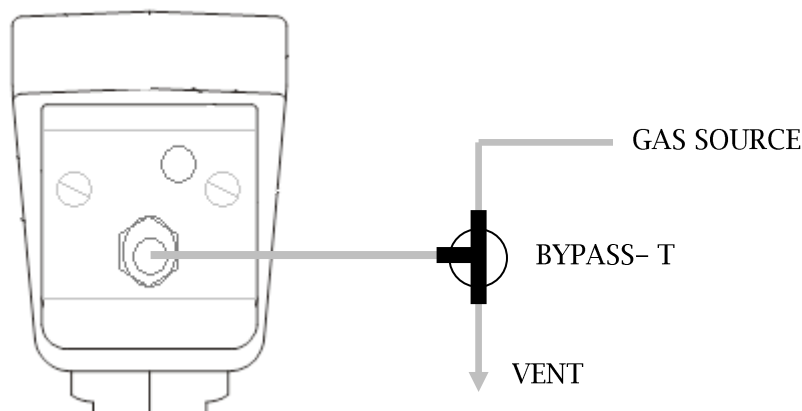

Figure 20. Gas source connection.

Sensor Calibration Steps

The steps required to calibrate the sensor are detailed in Table 14 below. You may elect to perform only the zero calibration, however, if you are planning to span, you should zero the sensor first. Calibrations are recorded in the sensor’s calibration history, so make certain the date and time are correct on the “Main Display”.

Make certain the date and time are correct on the “Main Display”

Table 14. Sensor calibration steps.

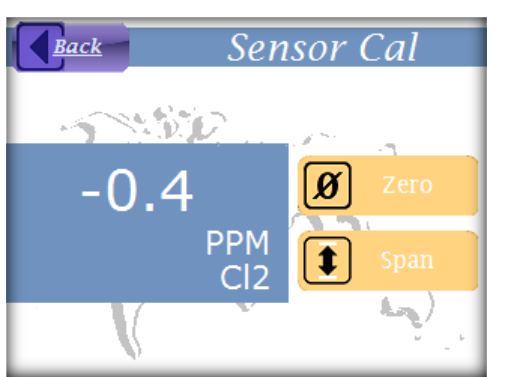
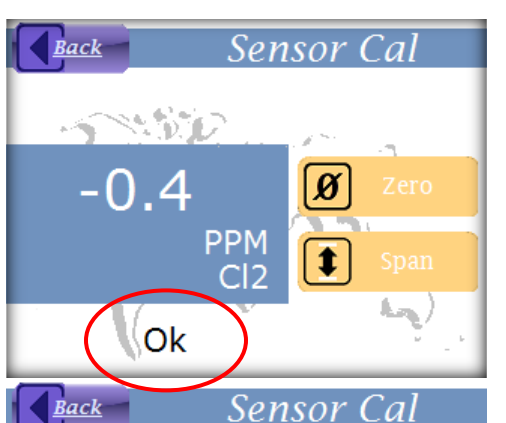
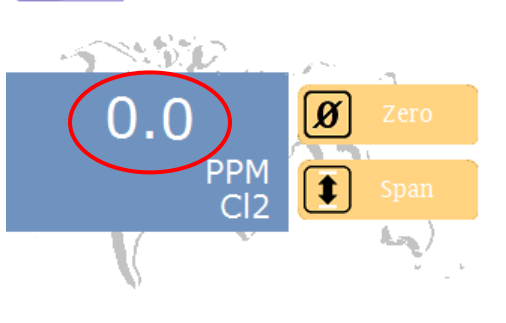
Description	Display
<p>Sensor Cal Page</p> <p>On the “Main Display” page, touch the “Menu” button. Touch the “Sensor” button, and then touch the “Calibrate” button. This will present the “Sensor Cal” page, as shown on the right. The target gas name, units of measure, and “un-blanked” gas reading appear on this page so that you may double-check your gas source, and watch for a stable reading. The page is displayed for at least 30 minutes without touching the display (longer if the “Menu Timeout” setting is greater than 30 minutes). This is normally enough time for a zero or span calibration.</p>	
<p>Zero Calibration</p> <p>Navigate to the “Sensor Cal” page (above). Expose the sensor to a gas source known to be free of the target gas, and any interfering gases (see Gas Interferences on page 41).</p> <p>For toxic gas sensors, this is usually atmospheric air, but may be bottled “Zero Air”, or Nitrogen. For O₂ sensors, Nitrogen is required. Nitrogen is usually stored in a pressurized bottle or cylinder, so refer to Pressurized Gas Sources on page 35 for details about connecting it.</p>	
<p>When the reading has stabilized at its lowest value (usually less than 4 minutes), and is not 0, touch the “Zero” button. “Ok” will appear below the gas reading for 2 seconds, and the reading will change to 0.</p>	

Description**Span Calibration**

Navigate to the “Sensor Cal” page (above). If using a pressurized gas source (very likely for toxic gas sensors), take note of the source gas concentration. Start the flow of gas to the sensor.

When the reading has stabilized at its highest value (usually less than 10 minutes), touch the “Span” button. The numeric keypad control will appear and display the current gas reading, as shown on the right. Use the keypad to enter the known concentration of the gas source, and then touch the “OK” button to perform the span, or touch the “Back” button to close the control and return without spanning. Stop the flow of gas to the sensor.

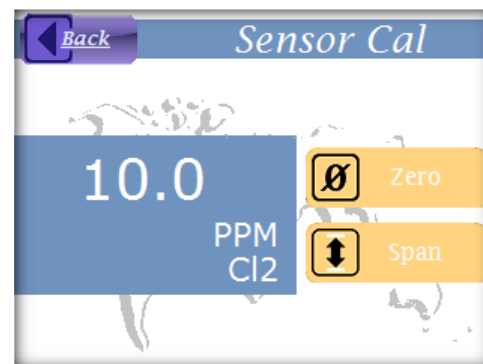
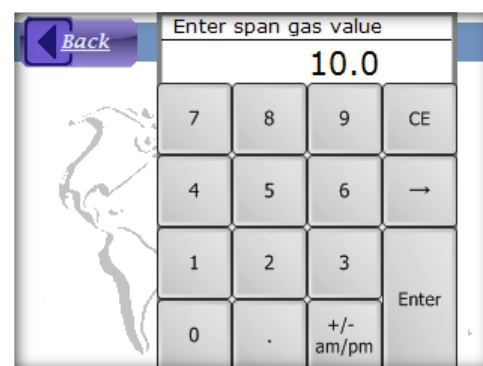
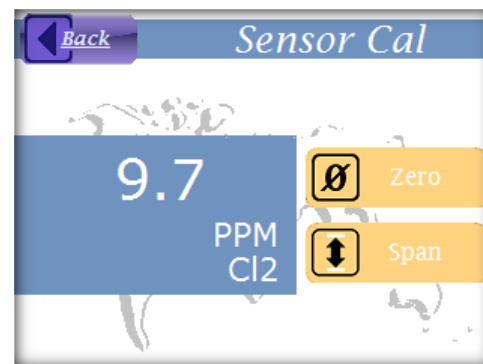
Display**Calibration History**

The H10 sensor has memory for 63 zero and 63 span calibration records. Each record has the date of calibration, and data pertaining to the type of calibration.

Zero calibration records save the gas reading prior to performing the calibration. This is the amount of “drift” since the last zero calibration.

Span calibration records save the sensitivity of the sensor, computed at the time of calibration. Sensitivity is defined as the sensor output divided by the source gas concentration, often expressed in terms of “uA/PPM”.

A reference span calibration is performed at the factory when the sensor is manufactured. This records the sensitivity of the sensor when new, and under ideal calibration conditions. The D16 displays all subsequent span calibration sensitivity data as a percentage of the reference span sensitivity. A value of 100% indicates the sensitivity has not changed. Lower values indicate decreased sensitivity. Values much greater than 100% may indicate an error in the span calibration gas, flow rate, or numeric entry. It is recommended to replace the sensor when the sensitivity decreases to 10% or lower.

Steps for viewing the calibration history are detailed in Table 15 below.

Table 15 Viewing calibration history.

<i>Description</i>	<i>Display</i>
<p>Cal History Page</p> <p>On the “Main Display” page, touch the “Menu” button, followed by the “Sensor” button, and then touch the “Cal History” button. This will present the “Cal History” page, as shown on the right.</p> <p>The page presents calibration records on two controls, one for zero records (top), and the other for span records (bottom). The controls are nearly identical and display the record number, date, and gas “Reading” for zero records, and “% Sensitivity” for span records.</p> <p>When the page first appears, the most recent calibrations are displayed in each control, and the record numbers will indicate how many calibrations have been performed (1-63). To view older records, touch the control and use the up and down buttons to scroll through them.</p>	

Table 16 Viewing the Sensor Info page.

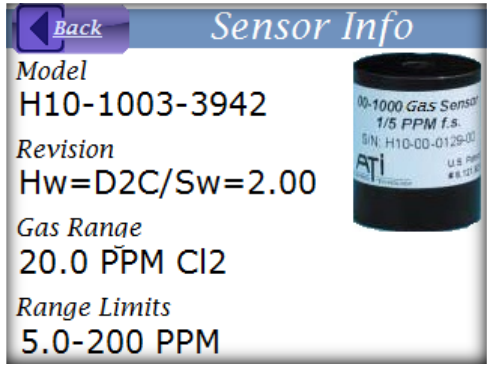
<i>Description</i>	<i>Display</i>
<p>Sensor Info Page</p> <p>On the “Main Display” page, touch the “Menu” button, followed by the “Sensor” button, and then touch the “Info” button. This will present the “Sensor Info” page, as shown on the right.</p>	 <p>The screenshot shows a screen titled "Sensor Info" with a "Back" button in the top left. The text on the screen lists the following information:</p> <ul style="list-style-type: none"> Model: H10-1003-3942 Revision: Hw=D2C/Sw=2.00 Gas Range: 20.0 PPM Cl₂ Range Limits: 5.0-200 PPM <p>To the right of the text is a small image of a cylindrical gas sensor with a label that includes "00-1000 Gas Sensor", "1/5 PPM f.s.", "ATI", and "U.S. Patent # 6,122,100".</p>

H10 Sensor Response Times

The table below lists the time required to obtain readings of 66%, and 90%, of an instantaneous exposure to various gasses. The times listed are for the sensor only, and do not include the travel time through the wand or tubing, or digital damping by the device. They are provided only for estimating the sampling period required for a representative reading.

Table 17. Gas response times.

<i>Sensor Type</i>	<i>Time to 66% (seconds)</i>	<i>Time to 90% (seconds)</i>
OXIDANT SENSORS (EXCEPT H₂O₂)	20	60
HYDROGEN PEROXIDE	40	120s
AMMONIA	30	120s
CARBON MONOXIDE	10	30
HYDROGEN	20	60
OXYGEN	15	45
NITRIC OXIDE	10	20
PHOSGENE	70	300s
HYDROGEN CHLORIDE	50	240s
HYDROGEN FLUORIDE	50	240s
HYDROGEN CYANIDE	40	120s
HYDROGEN SULFIDE	20	60
NITROGEN DIOXIDE	10	40
SULFUR DIOXIDE	10	40
HYDRIDE GASES	30	70
HYDROCARBON GASES	40	90

Gas Interferences

Some sensors exhibit a minor sensitivity to non-target gases and vapors. Table 18 lists the cross-sensitivity factors of sensors to various, “interference” gases. To use the table, find the sensor type along the top, and then scan down the column for the factor corresponding to one of the interference gases listed on the left. Multiplying the factor times the concentration of the interference gas produces the reading that would be displayed by the device. For example, an SO₂ sensor exposed to 1 PPM of HCN would produce a reading of 0.40 PPM. See notes following the table for additional comments.

Table 18. Cross-sensitivity factors.

Interference Gas	Sensor Type																	
	NH3	Cl ₂	O ₃	HF	HCl	HCN	H ₂ S	SO ₂	CO	H ₂	H ₂ O ₂	O ₂	NO	NO ₂	Hydride (4)	SiH ₄	COCl ₂	H-C
NH ₃	--			-0.05			-0.005											
CO	0.01				0.005		0.01	0.01	--	0.1	0.05			-0.05	(0.05)	0.08		0.3
H ₂	0.002				0.01	0.01	0.0003		0.1	--	0.03			-0.06		0.014		0.05
NO	0.08				1.5		0.4	0.08	0.1		0.09		--		(0.04)	2.0	-0.1	0.8
O ₂	*				*	*	*	*	*	*	*	--	*	*	*	*		*
Cl ₂	-0.5	--	1	2			-0.05	-0.2			-0.4			1.0	-0.01 (-0.1)	-0.2	0.1	
O ₃		0.05	--	1			-0.05	-0.2			-0.4			1.0	(-0.1)	-0.2		
HCl	-0.5			0.5	--		-0.005	0.02						-0.06	(-0.01)		0.05	0.2
HCN	0.1	-0.08	-0.5	-0.1	0.01	--		0.4	0.1					-0.2	0.05 (0.2)	0.2	0.5	0.1
HF				--														
H ₂ S	1.0	-0.1	-0.1	-0.3	3		--				6			-5.0			2	2
NO ₂	0.08	0.2	0.15	0.2	0.2		0.01	-0.3			-0.1			--	-0.001 (-0.1)	0.04	-1	0.1
SO ₂	-0.1	-0.01	-0.01	1	0.5	0.4	0.08	--			0.42			-0.8	(0.5)	0.1	0.2	0.4
Hydride					1.5	0.2	0.1	1			6			-3.5	--	5		2
SiH ₄					1.5	0.2	0.1	0.3			6			2	0.005 (0.5)	--		2
CO ₂																		
CH ₄																		
CH ₃ SH	0.3	-0.04	-0.03	-0.1	1		0.3				2			-1.5				1
C ₂ H ₂						.0005	0.002	1.7	0.1	0.1	0.02		0.005	-0.02	0.0001 (0.5)	0.05		1.2
C ₂ H ₄							0.002	0.3	0.1	0.1				-0.01	(0.1)	0.02		1
C ₂ H ₆ O	0.015				0.05	0.02	0.015	0.015			0.1			-0.07	(0.02)	0.1		0.7
COCl ₂																	--	

Notes on Interference Table:

1. Sensors marked with an asterisk in the oxygen column are 3 electrode sensors that require a minimum of 5% oxygen to operate properly. Hydrogen sensors require oxygen levels at least two times the maximum percent hydrogen value to be measured.
2. The data on the chlorine sensor also applies to bromine, chlorine dioxide, fluorine, and iodine sensors.
3. Data on the hydride sensor refers to arsine, phosphine, diborane, hydrogen selenide, and germane sensors. Response is not exactly 1:1 for all hydrides. Contact ATI for details if exact response is needed.
4. Data in parenthesis refers to PPM versions of the hydride sensors relative to phosphine. Response is not exactly 1:1 for all hydrides. Contact ATI for details.
5. The sensor column marked "H-C" stands for hydrocarbon sensors. These include ETO (ethylene oxide), formaldehyde, alcohol, acetylene, and vinyl chloride sensors.
6. Data in this table represents exposures to low PPM levels of the interfering gas. Very high concentrations of any interfering gas may cause either short term or long term response from a sensor.
7. Interference factors may vary over sensor lifetime. Calibration with interference gas is not recommended in most cases. Contact factory for more information.
8. Empty cells in table indicate insignificant cross-sensitivity.

Response Test

A response test is recommended before each use. Table 19 lists methods for generating gas that are appropriate for a target gas. Contact ATI for details on other methods.

Table 19. Gas generation methods.

<i>Target Gas</i>	<i>Quick Test Material and Method</i>
Oxidant Sensors (except H₂O₂)	Dry calcium hypochlorite or liquid bleach
Hydrogen Peroxide	Sodium bisulfite in plastic bottle
Ammonia Sensor	Household ammonia solution
Carbon Monoxide	Cigarette smoke
Hydrogen	No simple test. Must test with cylinder of hydrogen
Oxygen	Unit should read air levels
Nitric Oxide	No simple test. Must test with nitric oxide
Phosgene	No simple test. Must test with phosgene
Hydrogen Chloride	(2) drops of conc. HCl in plastic bottle
Hydrogen Fluoride	Dry calcium hypochlorite or liquid bleach
Hydrogen Cyanide	Sodium bisulfite in plastic bottle
Hydrogen Sulfide	Sodium sulfide in plastic bottle
Nitrogen Dioxide	Dry calcium hypochlorite or liquid bleach
Sulfur Dioxide	Sodium bisulfite in plastic bottle
Hydride Gases	No simple test. Must test with hydride gas.
Hydrogen Peroxide	30% Hydrogen Peroxide solution
Hydrocarbon Gases	Rubbing alcohol

Some of the methods above produce high gas levels in closed containers. It is best to approach the opening of the container, slowly, with only the tip of the wand, to reduce the level of exposure at the sensor. While a high exposure will not harm the sensor, it may take several minutes for it to recover.

Do not draw liquid into the wand. Sample the air space just above the liquid.

H10 Sensors and D12 or F12 Transmitters

As a convenience, D12 and F12 gas transmitters save the sensor “Range”, “Blanking”, “Averaging”, alarm level, and type settings, and restore them when the same or a similar type sensor (same part number) is installed. This may lead to confusion if these values are first set by the D16 and the sensor is installed into a D12 or F12 gas transmitter. The transmitter will change these settings if they differ from the saved settings.

System

System “About” Page

When the D16 starts it displays the “About” page, which is shown below in Figure 21. This page lists the revision level of the LCD, and the CPU revision and serial number. The page also appears by touching the “About” button on the “System Menu” page (see Configuring System Settings below).

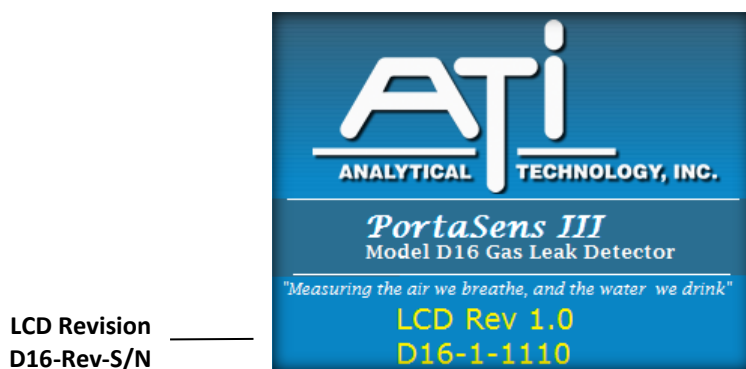

Figure 21 System About page.

Date and Time

The D16 contains a clock/calendar chip that is accurate to within approximately 1 minute per year. The clock is set at the factory and maintained by a dedicated battery so that it is unaffected by removing the primary battery. The date and time appear on the “Main Display”, and in data log files, and should be set to local time prior to using the data logger. Changing the date or time will not affect timestamps of data already logged. The date format may also be set to either “mm/dd/yyyy”, or “dd/mm/yyyy”. Changing it will affect dates on the display, and in new log files. However, there is no effect on existing files.

Auto-shutdown

The D16 features a timer that will turn power off automatically when the display is not touched for a period of time. This is designed to conserve battery life when the “Wakeup” button is pressed accidentally. The feature is disabled by default and must be enabled by the user, during which, the time period may be specified. The D16 will not automatically shut down until the “Main Display or “Trouble” page is displayed, and no gas alarms are active.

Sound

The D16 includes a beeper that sounds to draw your attention to the display. The beeper is enabled by default, but may be disabled by the user.

Default Settings

The D16 provides a method to restore settings to their default values, which includes the time and date. However, the method does not change settings in the H10 sensor memory, so the full scale range, blanking, averaging, and alarm levels remain the same.

Configuring System Settings

Table 20 Configuring system settings.

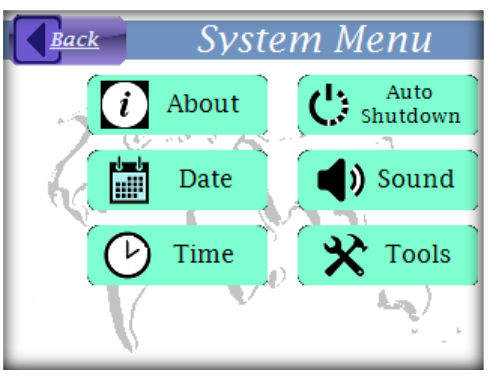
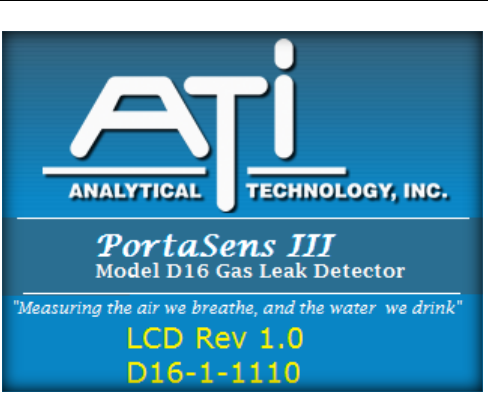
<i>Description</i>	<i>Display</i>
<p>System Menu Page</p> <p>On the “Main Display” page, touch the “Menu” button, and then the “System” button. The “System Menu” page will appear, as shown on the right.</p>	
<p>System About Page</p> <p>To view the “About” page, touch the “About” button on the “System Menu” page. Because it does not have a “Back” button, the page is displayed for only 4 seconds, and then automatically returns to the “System Menu” page. There are no settings presented on this page.</p>	

Description

Date

On the "System Menu" page, touch the "Date" button. When the "System Date" page appears, touch a button to select the corresponding date field, then touch the up and down buttons to adjust it. After all fields have been set, touch the "Ok" button to save the new date, or touch the "Back" button to exit without saving.

Date Format

The format of the date changes when the "Format" button is pressed, as shown to the right.

Display

MONTH/DAY/YEAR Format

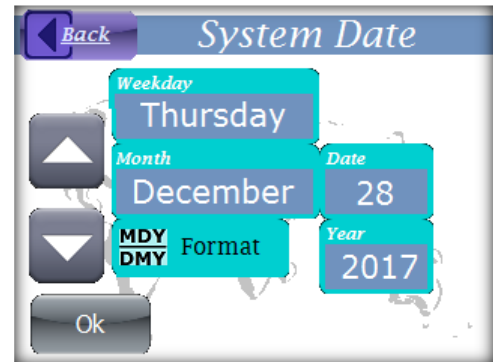

DAY/MONTH/YEAR Format

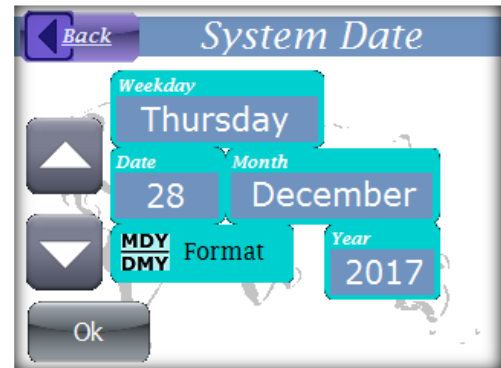

Time

On the "System Menu" page, touch the "Time" button. The numeric keypad control will appear and display the current time, as shown on the right. Time is presented in the am/pm format. Use the keypad to enter the new value, and then touch the "Ok" button to save it. Touch the "Back" button to close the control and return without saving.

Setting range: 12:00 – 11:59 am, 12:00 – 11:59 pm. Seconds are always set to 0 on a time change.

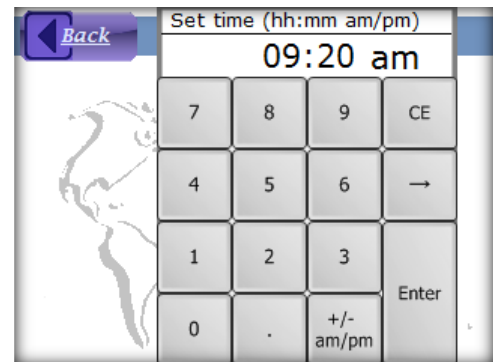

Description

Auto-shutdown

On the "System Menu" page, touch the "Auto Shutdown" button. The "spin" edit control will appear and display the current enable setting ("On" or "Off"), as shown on the right. Touch the up or down arrow to change the setting, then touch the "Ok" button to save it, or touch the "Back" button to return without saving.

When "On" is selected, touching the "Ok" button will pop up the numeric keypad with the shutdown period displayed. If necessary, change the period and touch the "Ok" button to save it, or touch the "Back" button to return without changing the shutdown period (automatic shutdown will still be enabled).

Time period range: 10 minutes to 18 hours.

Display

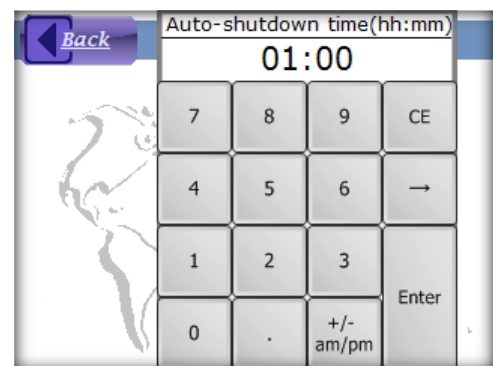
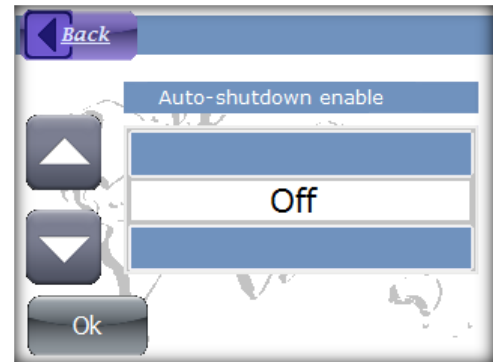

Sound

On the "System Menu" page, touch the "Sound" button. The "spin" edit control will appear and display the current sound enable setting ("On" or "Off"), as shown on the right. Touch the up or down arrow to change the setting, then touch the "Ok" button to save it, or touch the "Back" button to return without saving.

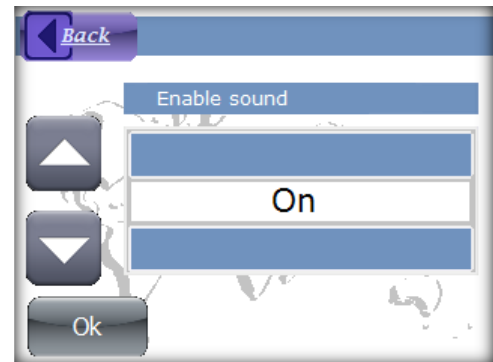

Description**Display****Restore Default Settings**

Warning: this function will overwrite stored settings, reset the date and time, and restart the D16.

On the "System Menu" page, touch the "Tools" button, and then touch the "Restore Defaults" button. The "spin" edit control appears with, "Are you sure?", as shown on the right. Touch the up or down button to select "Yes" and then touch the "Ok" button to restore the settings, or touch the "Back" button to return without restoring. Selecting "Yes" will perform the action, and then restart the D16.

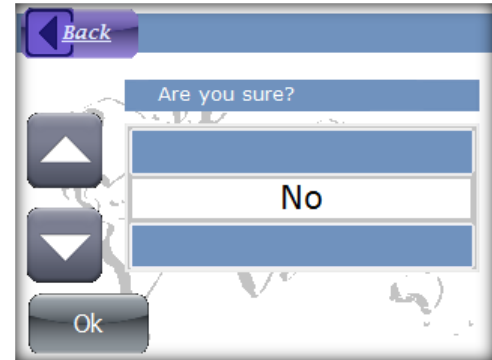

Timed Sampling

Description

The D16 features a type of “blind sampling” method for obtaining a more consistent gas reading. The result is a single reading, displayed only after sampling and filtering a consistent volume of gas. The four steps of the method are detailed below.

1. “Sampling” is displayed during the first step, while the pump draws gas to the sensor for a prescribed time interval to insure a consistent volume is sampled. This interval is determined by the “Sample Time” setting.
2. “Measuring” appears during the second step, while the reading is computed and filtered for another prescribed time interval to make certain the reading is sufficiently filtered. This interval is determined by the “Measure Time” setting.
3. “Done” appears at the conclusion of the second step, and the reading is displayed and held.
4. “Clearing” appears when the “Ok” button is touched, until the reading falls below a configured gas level, determined by the “Clear Level” setting.

Table 21 (below) details operation of the “Timed Sampling” method.

Operation

Table 21 Timed Sampling operation.

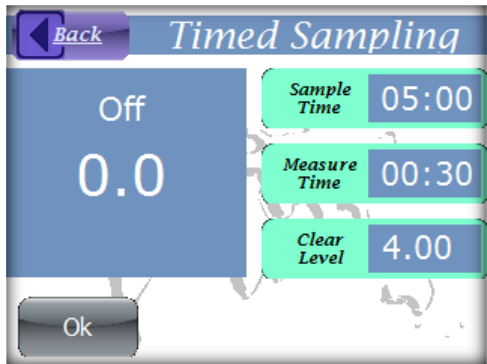
<i>Description</i>	<i>Display</i>
<p>Timed Sampling Page</p> <p>On the “Main Display” page, touch the “Menu” button, and then touch the “Timed Sampling” button. This will present the “Timed Sampling” page. The status of the method will be “Off”, as shown on the right.</p>	

Description

Display

Operation

On the "Timed Sampling" page, touch the "Ok" button. This will start the method and "Sampling" will appear on the display, followed by "Measuring", and "Done".

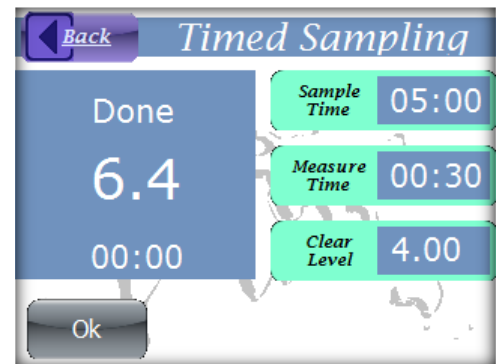
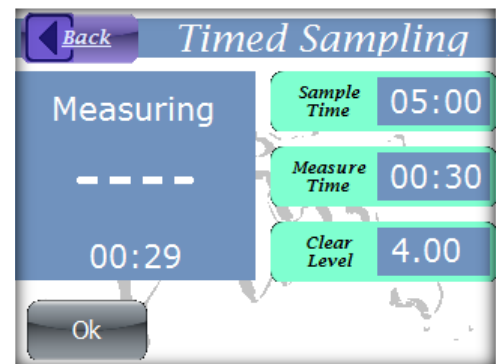
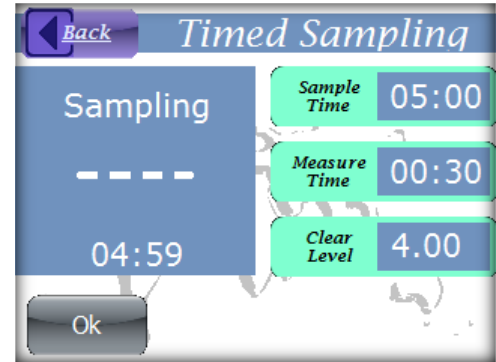

To Clear...

To clear the reading and end the method, touch the "Ok" button after "Done" appears. "Clearing" will appear and the fixed reading will be replaced with a live reading. When the live reading is at or below the "Clear Level", the method will end, and "Off" will reappear.

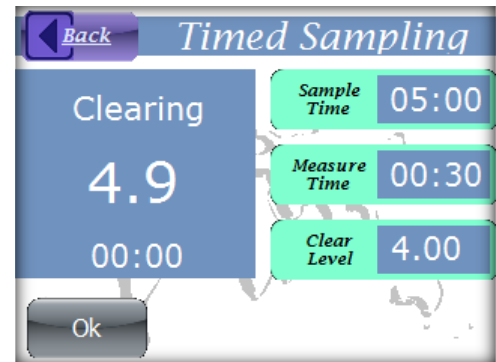

Configuring Timed Sampling

Table 22 Configuring Timed Sampling.

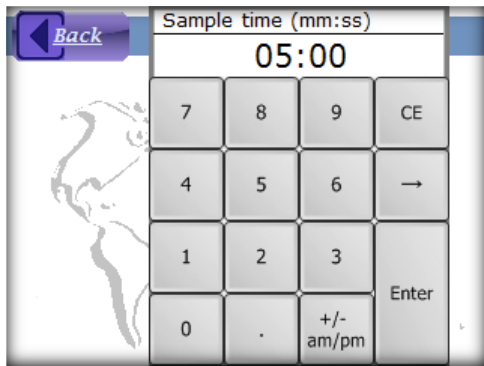
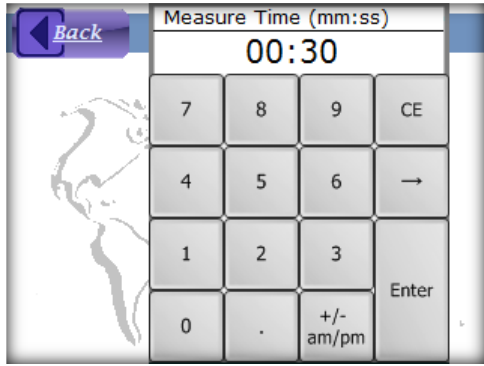
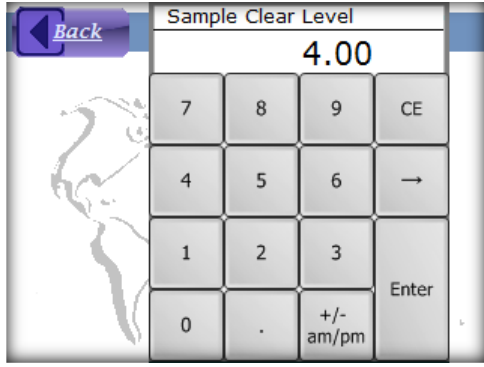
<i>Description</i>	<i>Display</i>
<p>Sample Time</p> <p>On the "Timed Sampling" page (see Table 21 above), touch the "Sample Time" button. The numeric keypad control will appear and display the current value, as shown on the right. Use the keypad to enter the new value, and then touch the "Ok" button to save it. Touch the "Back" button to close the control and return without saving.</p> <p>Setting range: 10s - 10m</p>	
<p>Measure Time</p> <p>On the "Timed Sampling" page (see Table 21 above), touch the "Measure Time" button. The numeric keypad control will appear and display the current value, as shown on the right. Use the keypad to enter the new value, and then touch the "Ok" button to save it. Touch the "Back" button to close the control and return without saving.</p> <p>Setting range: 10s - 10m</p>	
<p>Clear Level</p> <p>On the "Timed Sampling" page (see Table 21 above), touch the "Clear Level" button. The numeric keypad control will appear and display the current value, as shown on the right. Use the keypad to enter the new value, and then touch the "Ok" button to save it. Touch the "Back" button to close the control and return without saving.</p> <p>Setting range: 5 - 100 % of sensor "Range" setting.</p>	

Power

NiMH Battery

The NiMH (nickel metal-hydride) battery shipped with the unit will provide 10–12 hours of continuous operation when fully charged. When depleted, as indicated on the Main Display, it should be removed and charged in an external charger.

If the supplied NiMH battery is not available, an alkaline battery may be used. A high quality alkaline battery is likely to provide 6 or more hours of operation.

Two features are available to help extend battery life, “Display Sleep”, and “Auto-shutdown”. The “Display Sleep” (mode) allows you to turn off the display and continue to monitor gas levels and log data. The display is restored when a gas or trouble alarm is detected, or when the “Wakeup” switch is pressed. The “Display Sleep” mode is selected from the “Display Menu” (see Sleep Mode on page 17). The “Auto-shutdown” feature automatically turns off the D16 when the display has not been touched for a prescribed period of time. This feature is disabled by default, but may be enabled through the configuration settings. See Auto-shutdown on page 44 to enable this feature.

USB Power

The D16 is powered from the USB connection during data transfers, and is even capable of normal operation. Power may be supplied from a USB host, or a USB charger with at least a 200mA rating. Connecting USB power restarts the D16, even during normal operation. The battery is effectively disconnected when operating from USB power, and may be removed. Exiting USB mode switches the D16 into normal operation. The USB logo replaces the battery indicator on the “Main Display”, and if the battery is removed, “NO BATTERY” appears in the upper right corner.

Shutdown

Touching the “Off” button on the “Main Display” or “Trouble Display” page shuts down the D16, as does holding down the “Wakeup” switch for one second. The D16 will shut down automatically if the sensor is removed for 5 minutes, or if the battery voltage drops below 1 volt.

When shut down, the D16 display is turned off and the CPU is stopped. However, power is still applied to the sensor to maintain cell bias. Holding down the “Wakeup” switch for one second restores normal operation, as does installing a battery, or connecting a USB charger. Connecting to a USB host causes the D16 to enter USB mode, which may be exited for normal operation.

MAINTENANCE

Intake Filter

The intake filter is a small disk located under the manifold lid (see Figure 2 on page 5). A blocked filter will slow the response of the D16, and cause the pump motor to run at a higher rate, potentially lowering the battery life between charges. Check the filter once a month and replace it, if required. Extra filters are shipped in the original kit, and additional filters are available from the factory.

Battery Contacts

The D16 is shipped with a high quality NiMH D-Cell battery that should provide years of service. Like many battery powered devices, corrosion at the contact terminals, or even the battery itself, can lower the supply voltage. The D16 battery contacts are coated at the factory with a dielectric grease to reduce corrosion, and it is recommended to reapply good quality dielectric grease to the terminals once a year. Apply a thin coat of grease over the entire metal contact in the cap, and to the contact end of the compression spring inside the battery holder.

TROUBLES AND EXCEPTIONS

Trouble Messages

The D16 CPU detects problems and presents a message on the “Trouble Display”, shown in Figure 22. Trouble messages are listed below in Table 23. If the trouble has a corrective action listed, try that first; otherwise, perform the corrective actions listed in General Corrective Actions on page 57.



Figure 22 Trouble page.

Table 23 Trouble messages and corrective actions.

<i>Trouble Message</i>	<i>Corrective Action(s)</i>
LCD bus port error	See “General Corrective Actions”
LCD bus protocol error	See “General Corrective Actions”
LCD bus response error	See “General Corrective Actions”
LCD bus timeout	See “General Corrective Actions”
Gas sensor signal error	See “General Corrective Actions”
LCD bus error	See “General Corrective Actions”
SPI bus error	See “General Corrective Actions”
Gas temperature read error	Replace the sensor
Gas sensor under-range	Replace the sensor
Gas sensor removed	Reinstall the sensor
Gas sensor NVM error	Replace the sensor
Gas sensor config error	Replace the sensor
User NVM1 CRC error	See “General Corrective Actions”

Factory NVM1 CRC error	See “General Corrective Actions”
Micro-SD card file error	See “General Corrective Actions”
Micro-SD card h/w error	See “General Corrective Actions”
Power failure	See “General Corrective Actions”
Device uncalibrated	See “General Corrective Actions”
CPU error	See “General Corrective Actions”
Gas sensor uncalibrated	Replace the sensor
Hardware failure	See “General Corrective Actions”

Pump Troubles

Table 24 details the pump status and trouble messages that appear in the upper right corner of the “Main Display”.

Table 24 Pump status and troubles.

<i>Trouble</i>	<i>Corrective Action(s)</i>
CHECK FLOW	The D16 has detected a significant flow restriction that it cannot compensate for. Clear/clean any restriction in the sampling wand or attached tubing, or shorten the tubing. If the problem cannot be corrected, increase the motor speed by adjusting the pump motor duty cycle control. See Pump on page 28.
NO PUMP	The pump has malfunctioned or become disconnected. Unfortunately, there is no on site remedy for this problem. Please call to return the unit.
PUMP OFF	The pump has been permanently disabled by a setting change (status message, not a trouble).

Other Troubles

Use the following table to help identify and correct problems that might occur.

Table 25 Other troubles.

<i>Symptom</i>	<i>Possible Cause and Corrective Action</i>
D16 does not start	Perform "General Corrective Actions".
Display not working	Display problems will cause a black screen at startup, which may or may not include a description of the problem, such as "Drive not mounted". Perform the "General Corrective Actions" first. If the problem persists, contact the factory to schedule a repair.
Frequent low battery warning	<p>If a low battery indication is occurring within 3 hours of operation after fully charging, examine the battery contacts for signs of corrosion or battery leakage, especially if operating primarily with alkaline batteries. If a blue-green corrosion is evident, use a toothbrush to clean with white vinegar. Follow this with a solution of baking soda to neutralize any residual acid, then follow with clean with deionized water. Scrape or sand any large patches of corrosion, and clean up any residue with 91% isopropyl alcohol. Reapply dielectric grease to the battery contacts, as outlined in Battery Contacts on page 53.</p> <p>If the D16 battery life does not match specifications, perform the "General Corrective Actions" first. Batteries have evolved over the years, and so have battery chargers. The optional D16 battery charger is a smart charger, designed to monitor the batteries while charging. Older, simple chargers were designed to charge for a fixed length of time and then shut off. This may not be sufficient to charge the D16 batteries fully.</p>
No response to gas	Verify the intake filter is clean and the pump is running and providing a flowrate of at least 400 cc/min (0.85 SCFH). If not, adjust the pump motor speed (duty cycle) as outlined in Pump on page 28. The sensor may be at, or nearing, its normal end-of-life and may need to be replaced.
Pump trouble message persists.	The intake filter, flexible wand, or inlet/outlet tubing may be obstructed. Replace the filter and/or clear any blockages. Keep wand and tubing free of all liquids. Verify the flow rate using the supplied flow meter (see Pump on page 28),
Alarm slow to clear	<p>Check that the sensor "Damping" value is set below 20. If so, the sensor may have been exposed to a high concentration of target gas. If so, it will require an extended period of time for to recover. Leave the device running while sample zero air. If the condition does not clear after 6 hours, replace the sensor or contact ATI Service Department.</p> <p>Another possibility (although, uncommon) is that the sensor has been incorrectly calibrated, and the reading is no longer accurate. Verify the readings using certifiable zero and span gas sources.</p>

<i>Symptom</i>	<i>Possible Cause and Corrective Action</i>
USB port not working	The D16 may not be able to operate from an unpowered USB hub, or a hub on the front panel of a PC. Move to a different USB port.
Windows reports, "USB Driver Not Installed"	<p>When the D16 is first connected to a USB host, operating systems like Microsoft Windows will install a proper USB Mass Storage Device driver and enable it. This normally takes under 4 seconds, after which, the D16 powers on its LCD and displays the "USB Mode" page.</p> <p>If the host reports the driver was not installed, it usually means a driver was installed, but that the port may have momentarily reset the D16 (which made it appear to lose communication). Remove and re-plug the USB connector.</p> <ul style="list-style-type: none"> • Move the USB connection to a different USB host port, or a different PC. • Replace the USB cable. <p>This should correct the problem and the host should display the contents of the D16 drive reliably from then on.</p>

General Corrective Actions

Troubles often stem from a few common causes. Performing the steps below may help to quickly diagnose, isolate, and resolve issues.

1. Re-start the D16.
2. If operating from a battery,
 - a. Clean the battery contacts and reapply a good quality dielectric grease
 - b. Replace the battery
 - c. Change to a USB power source
 Otherwise, if operating from USB power,
 - d. Move to a different USB port, or to a USB wall charger. USB ports located on the front of some PCs are usually hubs and power may be limited.
3. If none of the steps above resolve the problem, replace the sensor if one is available. An H10 sensor rarely causes an electrical problem; however, contacts on the sensor may become contaminated.

Exception Messages

Exception messages are returned when the D16 denies requests to change settings and run services, like sensor “Zero” and “Span”. Many are not likely to occur because the cause of the exception will be reported on the “Trouble” page. However, some exceptions are generated in response to exceeding limits and updating non-volatile memory.

Table 26 Exception messages.

<i>Exception Message</i>	<i>Comment</i>
Sensor trouble.	The sensor is missing, or a pre-existing sensor error is preventing the action from completing.
No data logged.	No samples have been recorded in the data logger.
Data logger busy.	The data logger is waiting for a previous action to complete.
Sensor memory or configuration error.	The action resulted in an error in the sensor’s non-volatile memory.
Cannot perform this action.	The action is not supported in version of the D16 or H10 sensor.
Sensor input low.	The magnitude of the sensor signal is too low to complete the action.
Sensor input high.	The magnitude of the sensor signal is too high to complete the action.
Sensor power on delay.	The sensor is in a timed warmup period.
Trouble alarm.	The Trouble alarm is active.
Input data low.	The value entered by the user is too low to complete the action.
Input data high.	The value entered by the user is too high to complete the action.
Setup memory error.	A non-volatile user memory error occurred performing the action.
Alarm disabled.	The action cannot be applied to the subject alarm because it is currently disabled.
Alarm active, cannot continue.	The action cannot be performed because an alarm is active.

<i>Exception Message</i>	<i>Comment</i>
Factory settings memory error.	A non-volatile factory memory error occurred performing the action.
Device error.	A hardware component failed while performing the action.
Message too long.	Noise, low power, or an internal failure has caused an internal data communication error.
Syntax error.	Same as above
Invalid command.	Same as above
Invalid, missing, or extra argument(s).	Same as above
Invalid register(s).	Same as above
Invalid service request.	Same as above
Clock reset - restore correct date and time.	The action cannot be completed until the date and time have been set.
Pump not connected.	The pump or detection circuit has malfunctioned, and pump operation cannot be detected.

SPARE PARTS

Table 27 Spare parts.

<i>Item</i>	<i>Part No.</i>
Battery, D-Cell, NiMH	29-0014
USB Cable, A to Mini B	31-0216
Front Panel Overlay	34-0581
Bypass "T"	00-1088
Quick Disconnect Fitting	44-0096
Filter Disks (pkg. of 10)	05-0038
Flexible Wand	03-0176
Flow Meter with Tubing Adapter	03-0107
Carrying Case	90-0009
USB Port Cap (w/ mounting screw)	03-0206
Battery Compartment Cap Assembly	03-0194
Port Barb Fitting	44-0123

H10 Gas Sensor Modules

The table below lists the part number, gas name, and chemical symbol of the target gas for each H10 module, and groups them by gas type. The table also lists the minimum and maximum values of each sensor's range setting, and the highest reading resolution possible. The table also indicates the type of cell installed in the sensor: EC (electro-chemical), PEL (pellistor), or NDIR (non-dispersive infrared).

Table 28. H10 gas sensor modules.

<i>Gas Name</i>	<i>Symbol</i>	<i>Min. Range</i>	<i>Max. Range</i>	<i>Def. Range</i>	<i>Rdg Res. (Min. Rng)</i>	<i>Units</i>	<i>Part No.</i>	<i>Type</i>
OXIDANT GASES								
Bromine	Br ₂	1	5	2	0.01	PPM	00-1000	EC
Bromine	Br ₂	5	200	20	0.1	PPM	00-1001	EC
Chlorine	Cl ₂	1	5	2	0.01	PPM	00-1002	EC
Chlorine	Cl ₂	5	200	20	0.1	PPM	00-1003	EC
Chlorine dioxide	ClO ₂	1	5	1	0.01	PPM	00-1425	EC
Chlorine dioxide	ClO ₂	1	5	2	0.01	PPM	00-1004	EC
Chlorine dioxide	ClO ₂	5	200	20	0.1	PPM	00-1005	EC
Chlorine dioxide	ClO ₂	200	1000	1000	1	PPM	00-1359	EC
Fluorine	F ₂	1	5	2	0.01	PPM	00-1006	EC
Fluorine	F ₂	5	200	20	0.1	PPM	00-1007	EC
Hydrogen peroxide	H ₂ O ₂	10	100	20	0.1	PPM	00-1042	EC
Hydrogen peroxide	H ₂ O ₂	200	2000	1000	1	PPM	00-1169	EC
Iodine	I ₂	1	5	2	0.01	PPM	00-1036	EC
Iodine	I ₂	5	100	20	0.1	PPM	00-1037	EC
Ozone	O ₃	1	5	2	0.01	PPM	00-1008	EC
Ozone	O ₃	5	200	20	0.1	PPM	00-1009	EC
Ozone	O ₃	500	2000	1000	1	PPB	00-1163	EC
Ozone	O ₃	200	1000	1000	1	PPM	00-1358	EC
GENERAL GASES								
Ammonia	NH ₃	50	500	100	1	PPM	00-1010	EC
Ammonia	NH ₃	500	2000	1000	1	PPM	00-1011	EC
Carbon monoxide	CO	50	1000	100	1	PPM	00-1012	EC
Hydrogen	H ₂	1	10	4	0.01	%	00-1013	EC
Hydrogen	H ₂	500	2000	2000	1	PPM	00-1041	EC
Nitric oxide	NO	50	500	100	1	PPM	00-1021	EC
NOx	NOx	50	500	50	1	PPM	00-1181	EC
Oxygen	O ₂	5	25	25	0.1	%	00-1014	EC
Phosgene	COCl ₂	1	5	2	0.01	PPM	00-1015	EC
Phosgene	COCl ₂	5	100	10	0.1	PPM	00-1016	EC
ACID GASES								
Acid Gases	Acid	10	200	20	0.1	PPM	00-1038	EC
Acetic Acid	HAc	100	500	100	1	PPM	00-1045	EC
Peracetic acid	PAA	1	5	2	0.01	PPM	00-1704	EC
Peracetic acid	PAA	10	100	20	0.1	PPM	00-1705	EC
Hydrogen bromide	HBr	10	200	20	0.1	PPM	00-1455	EC
Hydrogen chloride	HCl	10	200	20	0.1	PPM	00-1017	EC

Hydrogen cyanide	HCN	10	200	20	0.1	PPM	00-1018	EC
Hydrogen fluoride	HF	10	200	20	0.1	PPM	00-1019	EC
Hydrogen sulfide	H ₂ S	10	200	50	0.1	PPM	00-1020	EC
Hydrogen sulfide	H ₂ S	500	1000	1000	1	PPM	00-1469	EC
Nitrogen dioxide	NO ₂	10	200	20	0.1	PPM	00-1022	EC
Sulfur dioxide	SO ₂	10	500	20	0.1	PPM	00-1023	EC
HYDRIDE GASES								
Arsine	AsH ₃	10	200	10	0.1	PPM	00-1025	EC
Arsine	AsH ₃	500	2000	1000	1	PPB	00-1024	EC
Diborane	B ₂ H ₆	10	200	10	0.1	PPM	00-1027	EC
Diborane	B ₂ H ₆	500	2000	1000	1	PPB	00-1026	EC
Germane	GeH ₄	10	200	10	0.1	PPM	00-1029	EC
Germane	GeH ₄	500	2000	1000	1	PPB	00-1028	EC
Hydrogen selenide	H ₂ Se	10	200	10	0.1	PPM	00-1031	EC
Hydrogen selenide	H ₂ Se	500	2000	1000	1	PPB	00-1030	EC
Phosphine	PH ₃	10	200	10	0.1	PPM	00-1033	EC
Phosphine	PH ₃	500	2000	1000	1	PPB	00-1032	EC
Phosphine	PH ₃	200	2000	1000	1	PPM	00-1034	EC
Silane	SiH ₄	10	200	10	0.1	PPM	00-1035	EC
HYDROCARBON GASES								
Acetylene	C ₂ H ₂	200	2000	500	1	PPM	00-1057	EC
Alcohol	C _x OH	50	500	200	1	PPM	00-1043	EC
Alcohol	C _x OH	500	2000	2000	1	PPM	00-1044	EC
Dimethylamine	DMA	100	200	100	1	PPM	00-1450	EC
Ethylene oxide	C ₂ H ₄ O	20	200	20	0.1	PPM	00-1039	EC
Formaldehyde	HCOH	20	200	20	0.1	PPM	00-1040	EC
Formaldehyde	HCOH	500	2000	1000	1	PPM	00-1349	EC
Hydrocarbon vapors	HCV	50	500	100	1	PPM	00-1516	EC

PRODUCT WARRANTY

Analytical Technology, Inc. (Manufacturer) warrants to the Customer that if any part(s) of the Manufacturer's equipment proves to be defective in materials or workmanship within the earlier of 18 months of the date of shipment or 12 months of the date of start-up, such defective parts will be repaired or replaced free of charge. Inspection and repairs to products thought to be defective within the warranty period will be completed at the Manufacturer's facilities in Collegeville, PA. Products on which warranty repairs are required shall be shipped freight prepaid to the Manufacturer. The product(s) will be returned freight prepaid and allowed if it is determined by the manufacturer that the part(s) failed due to defective materials or workmanship.

This warranty does not cover consumable items, batteries, or wear items subject to periodic replacement including lamps and fuses.

Gas sensors carry a 12 months from date of shipment warranty and are subject to inspection for evidence of misuse, abuse, alteration, improper storage, or extended exposure to excessive gas concentrations. Should inspection indicate that sensors have failed due to any of the above, the warranty shall not apply.

The Manufacturer assumes no liability for consequential damages of any kind, and the buyer by acceptance of this equipment will assume all liability for the consequences of its use or misuse by the Customer, his employees, or others. A defect within the meaning of this warranty is any part of any piece of a Manufacturer's product which shall, when such part is capable of being renewed, repaired, or replaced, operate to condemn such piece of equipment.

This warranty is in lieu of all other warranties (including without limiting the generality of the foregoing warranties of merchantability and fitness for a particular purpose), guarantees, obligations or liabilities expressed or implied by the Manufacturer or its representatives and by statute or rule of law.

This warranty is void if the Manufacturer's product(s) has been subject to misuse or abuse, or has not been operated or stored in accordance with instructions, or if the serial number has been removed.

Analytical Technology, Inc. makes no other warranty expressed or implied except as stated above.

WATER QUALITY MONITORS

Dissolved Oxygen
Free Chlorine
Combined Chlorine
Total Chlorine
Residual Chlorine Dioxide
Potassium Permanganate
Dissolved Ozone
pH/ORP
Conductivity
Hydrogen Peroxide
Peracetic Acid
Dissolved Sulfide
Residual Sulfite
Fluoride
Dissolved Ammonia
Turbidity
Suspended Solids
Sludge Blanket Level
MetriNet Distribution Monitor

GAS DETECTION PRODUCTS

NH ₃	Ammonia
CO	Carbon Monoxide
H ₂	Hydrogen
NO	Nitric Oxide
O ₂	Oxygen
CO	Cl ₂ Phosgene
Br ₂	Bromine
Cl ₂	Chlorine
ClO ₂	Chlorine Dioxide
F ₂	Fluorine
I ₂	Iodine
H _x	Acid Gases
C ₂ H ₄ O	Ethylene Oxide
C ₂ H ₆ O	Alcohol
O ₃	Ozone
CH ₄	Methane (Combustible Gas)
H ₂ O ₂	Hydrogen Peroxide
HCl	Hydrogen Chloride
HCN	Hydrogen Cyanide
HF	Hydrogen Fluoride
H ₂ S	Hydrogen Sulfide
NO ₂	Nitrogen Dioxide
NO _x	Oxides of Nitrogen
SO ₂	Sulfur Dioxide
H ₂ Se	Hydrogen Selenide
B ₂ H ₆	Diborane
GeH ₄	Germane
AsH ₃	Arsine
PH ₃	Phosphine
SiH ₄	Silane
HCHO	Formaldehyde
C ₂ H ₄ O ₃	Peracetic Acid
DMA	Dimethylamine