

Typical installation with ICF valve stations

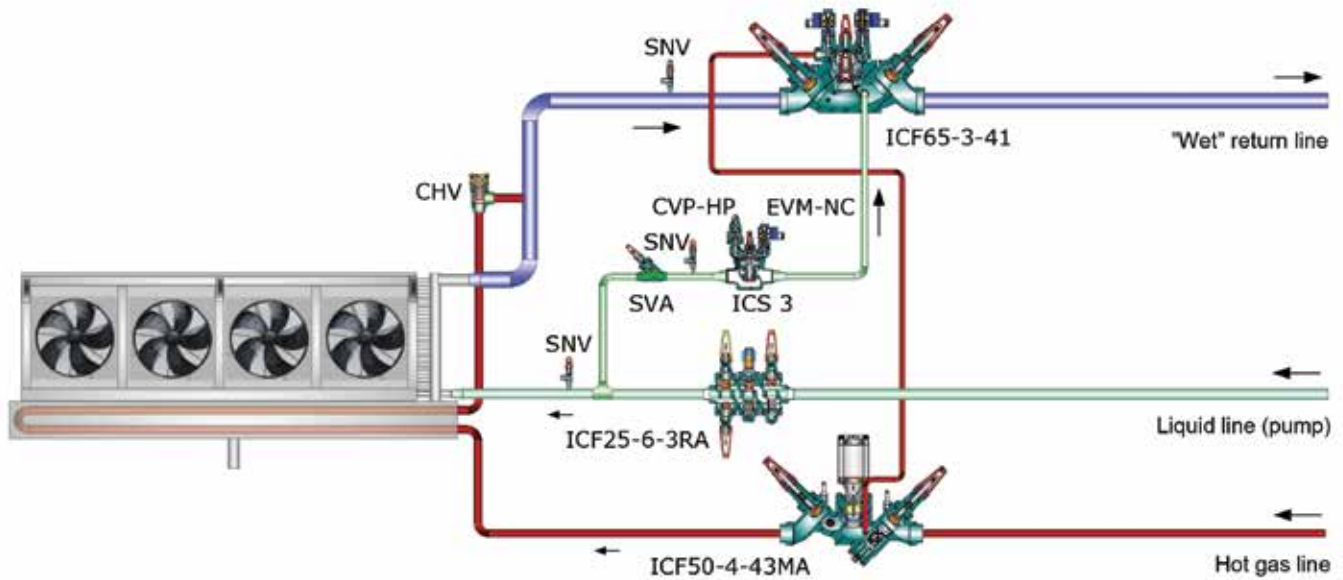

ICF nomenclature

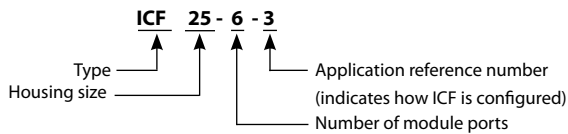

Common ICF applications

Application #1 is typically used for:
Pumped liquid lines in flooded systems without hot gas defrost

Application #1 has the following valve functions: Stop valve, strainer, solenoid with manual stem, HEV, stop valve			
Type	Connection Type/Size	Part No.*	List Price *
ICF20-6-1RA	3/4" SW	027L3005	\$1,628
ICF20-6-1RA	1" SW	027L3007	\$1,710
ICF20-6-1HRB	1" SW	027L3408	\$2,110
ICF20-6-1HRB	1 1/4" SW	027L3409	\$2,210
ICF25-6-1RA	1" SW	027L4003	\$2,132
ICF25-6-1RB	1 1/4" SW	027L4013	\$2,238
ICF25-6-1RB	1 1/2" SW	027L4017	\$2,391

* Price does not include coil. Coil must be ordered separately; see page 24 for coil ordering.

Application #1 example:
ICF 25-6-1RA

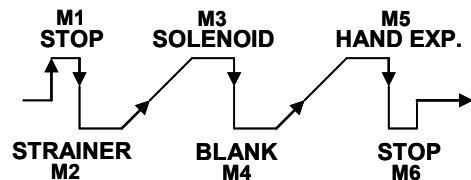

Application #2 and 3 are typically used for: Pumped liquid lines in flooded systems with hot gas defrost

Application #2 has the following valve functions:
Stop valve, strainer, solenoid with manual stem, HEV, stop/check valve

Type	Connection Type/Size	Part No. *	List Price *
ICF20-6-2RA	3/4" SW	027L3014	\$1,710
ICF20-6-2RA	1" SW	027L3016	\$1,795
ICF20-6-2HRB	1" SW	027L3412	\$2,216

Application #3 has the following valve functions:
Stop valve, strainer, solenoid with manual stem, check valve, HEV, stop valve

Type	Connection Type/Size	Part No. *	List Price *
ICF20-6-3HRB	1" SW	027L3416	\$2,216
ICF25-6-3RA	1" SW	027L4021	\$2,239
ICF25-6-3RB	1 1/4" SW	027L4031	\$2,350
ICF25-6-3RB	1 1/2" SW	027L4035	\$2,535

* Price does not include coil. Coil must be ordered separately; see page 24 for coil ordering.

Application #9 and 10 are typically used for: Hot gas defrost lines

Application #9 has the following valve functions:
Stop valve, strainer, solenoid with manual stem, stop valve

Type	Connection Type/Size	Part No. *	List Price *
ICF15-4-9H	1/2" SW	027L4527	\$1,278
ICF20-4-9H	3/4" SW	027L3351	\$1,447
	1" SW	027L3336	\$1,519
ICF25-4-9	1" SW	027L4064	\$1,724
	1 1/4" SW	027L4069	\$1,847
	1 1/2" SW	027L4073	\$2,051
ICF50-4-9S32	1 1/2" SW	148X1505	\$2,419
ICF50-4-9S40	1 1/2" SW	148X1514	\$2,469
	2" SW	148X1519	\$2,574
ICF50-4-9S50	2" SW	148X1500	\$2,768

Application #10 has the following valve functions:
Stop valve, strainer, solenoid with manual stem, HEV

Type	Connection Type/Size	Part No. *	List Price *
ICF20-4-10HRB	3/4" SW	027L3404	\$1,447
ICF25-4-10RA	1" SW	027L4077	\$1,724
ICF25-4-10RB	1 1/4" SW	027L4087	\$1,847
	1 1/2" SW	027L4091	\$2,051
ICF50-4-10S32	1 1/2" SW	148X1524	\$2,419
ICF50-4-10S40	2" SW	148X1525	\$2,574

* Price does not include coil. Coil must be ordered separately; see page 24 for coil ordering.

Application #2 example: ICF 20-6-2RA

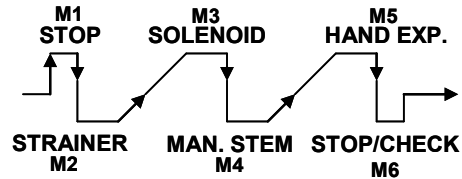

Application #3 example: ICF 25-6-3RB

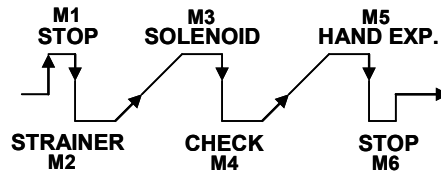

Application #9 example: ICF 25-4-9

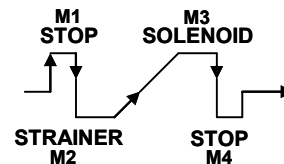

Application #10 example: ICF 25-4-10RB

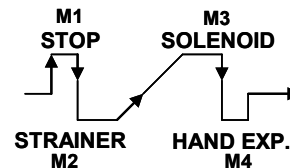

Common Coils *

Voltage	Electrical Connection	Part No.	List Price
110 AC	Terminal box	018F6813	\$50

* For other coil voltages and types, see p. 24

**Application #5 is typically used for:
Liquid make-up or direct expansion applications**

Application #5 has the following valve functions: Stop valve, strainer, solenoid with manual stem, motorized ICM valve, stop valve					
Type	Connection Type/Size	Part Number *		List Price *	
		Valve w/o Motor	ICAD 600A Motor	Valve w/o Motor *	ICAD 600A Motor *
ICF20-6-5MA33	3/4" SW	027L3154	027X0166	\$2,971	\$1,996
ICF20-6-5MA	3/4" SW	027L3038	027X0166	\$2,971	\$1,996
ICF20-6-5MA	1" SW	027L3040	027X0166	\$3,119	\$1,996
ICF20-6-5MB66	3/4" SW	027L3159	027X0166	\$2,971	\$1,996
ICF20-6-5MB66	1" SW	027L3160	027X0166	\$3,119	\$1,996
ICF20-6-5MB	3/4" SW	027L3127	027X0166	\$2,971	\$1,996
ICF20-6-5MB	1" SW	027L3045	027X0166	\$3,119	\$1,996
ICF20-6-5HMB	1" SW	027L3326	027X0166	\$3,152	\$1,996
ICF20-6-5HMC	1" SW	027L3330	027X0166	\$3,152	\$1,996
ICF20-6-5HMC	1¼" SW	027L3331	027X0166	\$3,309	\$1,996
ICF25-6-5MA	1" SW	027L4039	027X0166	\$3,669	\$1,996
ICF25-6-5MA	1¼" SW	027L4044	027X0166	\$3,852	\$1,996
ICF25-6-5MA	1½" SW	027L4132	027X0166	\$4,114	\$1,996

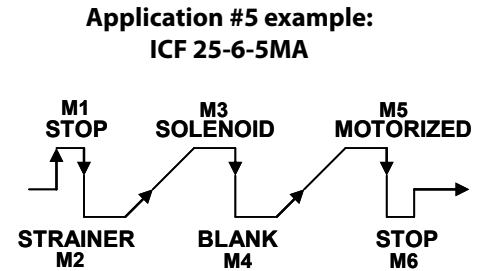

* ICF valve and ICAD 600A motor actuator must be ordered separately when ordering. ICAD 600A motor actuator is required for the motor valve to operate. Coil price not included.

Common Coils *

Voltage	Electrical Connection	Part No.	List Price
110 AC	Terminal box	018F6813	\$50
110 AC	Terminal box with GREEN pilot light	018F6816	\$94

* For other coil voltages and types, see p. 24

**Application #12, 13, and 90 are typically used for:
Direct expansion applications with pulse width modulating valves**

Application #12 has the following valve functions: Stop valve, strainer, pulse expansion valve, stop valve			
Type	Connection Type/Size	Part No.*	List Price *
ICF15-4-12	1/2" SW	027L4528	\$1,443
ICF20-4-12	3/4" SW	027L3091	\$1,612

* Price does not include coil. Coil must be ordered separately; see page 24 for coil ordering.

Application #13 has the following valve functions: Stop valve, strainer, pulse expansion valve, stop/check valve			
Type	Connection Type/Size	Part No.*	List Price *
ICF15-4-13	1/2" SW	027L4529	\$1,453
ICF20-4-13	3/4" SW	027L3094	\$1,622

* Price does not include coil. Coil must be ordered separately; see page 24 for coil ordering.

Application #90 has the following valve functions: Stop valve, strainer, solenoid w/ man. Stem, pulse expansion valve, stop valve			
Type	Connection Type/Size	Part No.*	List Price *
ICF20-6-90	3/4" SW	027L3055	\$1,710

* Price does not include coil. Coil must be ordered separately; see page 24 for coil ordering.

**Application #14 is typically used for:
Direct expansion applications with motorized valves**

Application #14 has the following valve functions: Stop valve, strainer, motorized ICM valve, stop valve					
Type	Connection Type/Size	Part Number *		List Price *	
		Valve w/o Motor	ICAD 600A Motor	Valve w/o Motor *	ICAD 600A Motor *
ICF20-4-14MA	3/4" SW	027L3099	027X0166	\$2,150	\$1,996
ICF20-4-14MB	1" SW	027L3106	027X0166	\$2,258	\$1,996
ICF20-4-14MC	1" SW	027L3112	027X0166	\$2,258	\$1,996
ICF20-4-14MC	1 1/4" SW	027L3113	027X0166	\$2,365	\$1,996
ICF25-4-14MA	1" SW	027L4104	027X0166	\$2,608	\$1,996
ICF25-4-14MA	1 1/4" SW	027L4109	027X0166	\$2,739	\$1,996
ICF25-4-14MA	1 1/2" SW	027L4140	027X0166	\$2,925	\$1,996
ICF25-4-14MB	1 1/4" SW	027L4114	027X0166	\$2,739	\$1,996
ICF25-4-14MB	1 1/2" SW	027L4118	027X0166	\$2,925	\$1,996

* ICF valve and ICAD 600A motor actuator must be ordered separately when ordering. ICAD 600A motor actuator is required for the motor valve to operate.

**Application #18 is typically used for:
Pumped liquid lines feeding 2 evaporators having separate HEVs**

Application #18 has the following valve functions: Stop valve, strainer, solenoid, stop/check valve			
Type	Connection Type/Size	Part No.*	List Price *
ICF20-4-18H	3/4" SW	027L3353	\$1,490
ICF20-4-18H	1" SW	027L3354	\$1,565
ICF25-4-18	1 1/4" SW	027L4137	\$1,883
ICF25-4-18	1 1/2" SW	027L4138	\$2,049

* Price does not include coil. Coil must be ordered separately; see page 24 for coil ordering.

Application#41 is used for gas-powered suction stop valve applications

Application #41 has the following valve functions: Stop valve, gas-powered ICLX valve, stop valve (NO strainer)			
Type	Connection Type/Size	Part No. *	List Price *
ICF 50-4-41	1 1/2" SW	027L5022	\$3,047
	2" SW	027L5024	\$3,198
ICF 65-3-41	2 1/2" BW	027L6522	\$3,893
	3" BW	027L6524	\$4,086

* Price does not include coils. Coils must be ordered separately; see page 24 for coil ordering.



Application #42 is used for regulator valve applications

Application #42 has the following valve functions: Stop valve, ICS Regulator, stop valve (NO Strainer)					
Type	ICS Port Size	ICS Variation (1)	Connection Type/Size	Part No. *	List Price *
ICF50-4-42S32-STD	1¼"	STD	1½"	148X1506	\$2,396
			2"	148X1510	\$2,501
ICF50-4-42S32-S	1¼"	S	1½"	148X1507	\$2,543
			2"	148X1511	\$2,648
ICF50-4-42S32-B	1¼"	B	1½"	148X1508	\$2,543
			2"	148X1512	\$2,648
ICF50-4-42S32-D	1¼"	D	1½"	148X1509	\$2,837
			2"	148X1513	\$2,942
ICF50-4-42S40-STD	1½"	STD	1½"	148X1515	\$2,446
			2"	148X1520	\$2,551
ICF50-4-42S40-S	1½"	S	1½"	148X1516	\$2,593
			2"	148X1521	\$2,698
ICF50-4-42S40-B	1½"	B	1½"	148X1517	\$2,593
			2"	148X1522	\$2,698
ICF50-4-42S40-D	1½"	D	1½"	148X1518	\$2,887
			2"	148X1523	\$2,992
ICF65-3-42S40-STD	1½"	STD	2½"	148X1534	\$3,096
ICF65-3-42S40-S	1½"	S	2½"	148X1535	\$3,243
ICF65-3-42S40-B	1½"	B	2½"	148X1536	\$3,243
ICF65-3-42S40-D	1½"	D	2½"	148X1537	\$3,537
ICF50-4-42S50-STD	2"	STD	2"	148X1501	\$2,745
ICF50-4-42S50-S	2"	S	2"	148X1502	\$2,892
ICF50-4-42S50-B	2"	B	2"	148X1503	\$2,892
ICF50-4-42S50-D	2"	D	2"	148X1504	\$3,186
ICF65-3-42S65-STD	2½"	STD	2½"	148X1526	\$3,408
			3"	148X1530	\$3,564
ICF65-3-42S65-S	2½"	S	2½"	148X1527	\$3,555
			3"	148X1531	\$3,711
ICF65-3-42S65-B	2½"	B	2½"	148X1528	\$3,555
			3"	148X1532	\$3,711
ICF65-3-42S65-D	2½"	D	2½"	148X1529	\$3,849
			3"	148X1533	\$4,005

* Price does not include coil. Coil must be ordered separately; see page 24 for coil ordering.



Application #43 is typically used for: Motorized regulating valve applications

Application #43 has the following valve functions: Stop valve, motorized ICM valve, stop valve (NO strainer)					
Type	Connection Type/Size	Part Number *		List Price *	
		Valve w/o Motor	ICAD 1200A Motor	Valve w/o Motor *	ICAD 1200A Motor *
ICF 50-4-43MB	1-½" SW	027L5018	027X0166	\$3,039	\$2,268
ICF 50-4-43MB	2" SW	027L5020	027X0166	\$3,463	\$2,268
ICF 65-3-43MB	2-½" BW	027L6518	027X0166	\$4,998	\$2,268
ICF 65-3-43MB	3" BW	027L6520	027X0166	\$5,448	\$2,268

* ICF valve and ICAD 1200A motor actuator must be ordered separately when ordering. ICAD 1200A motor actuator is required for the motor valve to operate. Coil price not included.

