

Installation and configuration guide

HBX Vapor Quality sensor - rodstyle

Sensors for optimizing Evaporator Control, both for DX (direct expansion) and overfeed - systems

For compressor protection and leakage detection (ammonia carbamate)



Introduction:

The rod style sensor is the old universal version of the vapor quality sensor family. The sensor is very sensitive to the installation method, but when installed correctly it works perfectly.

HBX Vapor Quality Sensors measures the Vapor Quality of the refrigerant vapor leaving an evaporator and use this signal for controlling the expansion valve. Thanks to the capacitive measurement principle it is able to measure the liquid content of the fluid leaving the evaporator without pressure drop.

For "DX" systems the vapor quality sensor can replace the conventional superheat control and is able to reduce the superheat to zero. The sensor can control the valve directly or it can provide the high vapor quality measurement for an external control system. The vapor quality sensor reacts instantaneously if the dryness of the gas is changed in the evaporator outlet. Experience has shown that the entire system is in better balance with minimum variation in pressure.

In overfeed and flooded systems the sensor is able to measure the low vapor quality in the evaporator outlet and control the circulation ratio (CR) by controlling the liquid valve or the pump capacity, either directly or as an input for a PLC.

The sensor is manufactured in stainless steel or carbon steel and can be used for all commonly used refrigerants CO₂, Hydrocarbons, ammonia, HFO's and HFC's with different settings. The HBX sensor is available in several versions, with and without temperature sensor and cable for direct connection to an expansion valve. Three types of expansion valves are supported: stepper motor, PWM pulse modulating ex. AKV valves and modulating 4-20mA controlled expansion valve.

A special ATEX/IECEX (EEx ib IIC) version is available for use in special hazardous areas and with flammable refrigerants. This product is only suited for external control and is not able to control an expansion valve directly.

Table of Contents

Introduction..... 1
 Safety Instruction 2
 Application and mounting strainer house version 3
 Application and mounting straight pipe version 4
 Application and mounting angle rod version 5
 Installation of temperature sensor..... 6
 Removal of electrical unit..... 7
 Sensor configuration 7
 How to use the sensor..... 8
 How to setup the sensor as input for a PLC 9
 Advanced settings for sensor as input for PLC input 10
 Using the sensor for flooded operation together with a PLC 11
 Operating a batch freezing process..... 11
 Using the alarm function for leakage control and comp. protection 11
 Calibration of sensor 12
 How does the expansion valve control loop work for DX operation.....14
 How to setup the sensor as direct controller—basic settings 16
 How to setup the sensor as direct controller—Advanced settings 17
 Controlling a flooded or semi flooded evaporator 18
 Connecting diagram stepper motor 19
 Connecting diagram motor valve 20
 Connecting diagram pulse modulating..... 21
 Connecting diagram PLC and ATEX/Ex/IECEx 22
 Remote setting 23
 LED indications on sensor head..... 24
 Use of the sensor with other refrigerants 24

Safety Instructions

CAUTION! Read this setup guide before installing and using the HBX Sensor.

Installation of HBX sensor must be carried out by a trained professional with in-depth knowledge of both refrigeration and electronics. Improper installation and use of the HBX Sensor may result in damage to material and/or people. The installation and use of the HBX Sensor must be done according to local regulation.

Altering type-approved equipment voids the type approval. The product's input and output, as well as its accessories, may only be connected as described in this guide. HB Products assumes no liability for damages resulting from failing to follow the instructions in this setup guide.

	<p>CAUTION! This symbol refers to a possible limitation of functionality or risk in usage.</p> <p>NOTE! Contains important additional information about the product and provides further advice.</p>
---	--

Intended use. The purpose of the HBX sensor is refrigerant measurement and control. If the HBX is to be used in a different way, prior, written consent must be obtained from HB Products.

Repair: Any repair must be carried out by a trained professional.

Disposal instructions: The HBX is designed for long life operation. If or when it becomes necessary to dispose of the sensor it must be done according to local regulation.

	<p>CAUTION! Factory settings do not guarantee safe operation since the configuration parameters depend on the system design</p>
---	--

Application and mounting instruction

Rod style sensor

The HBX-sensor is mounted after the evaporator and is able to measure the Vapor Quality (dryness) from 0.2 to 1. The output can be used as input to a PLC or it can control the expansion valve directly or both. The sensor have to be built into an elbow in the piping system and it is important to install the sensor element at the bottom of the pipe following the pipe. The sensor have to be mounted in downward sloping pipes to ensure drainage of refrigerant and oil.

The major part of the sensor element must be in the pipe, which means long sockets should be avoided

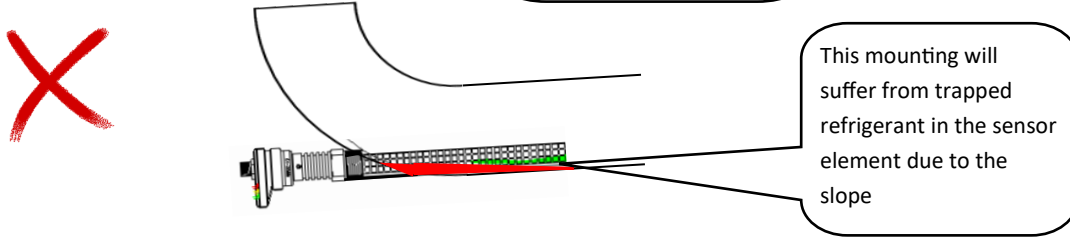
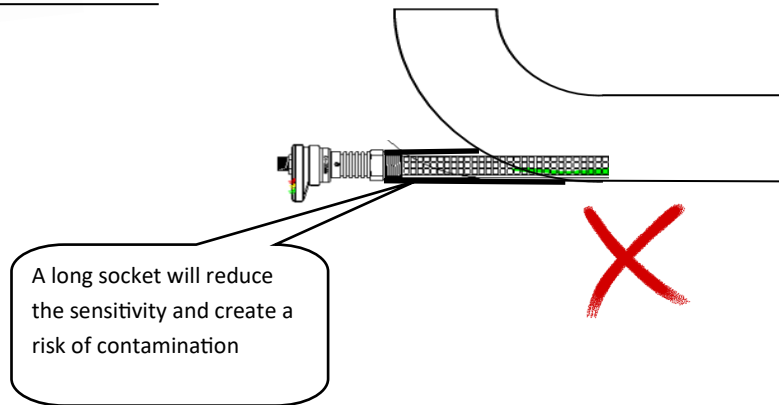
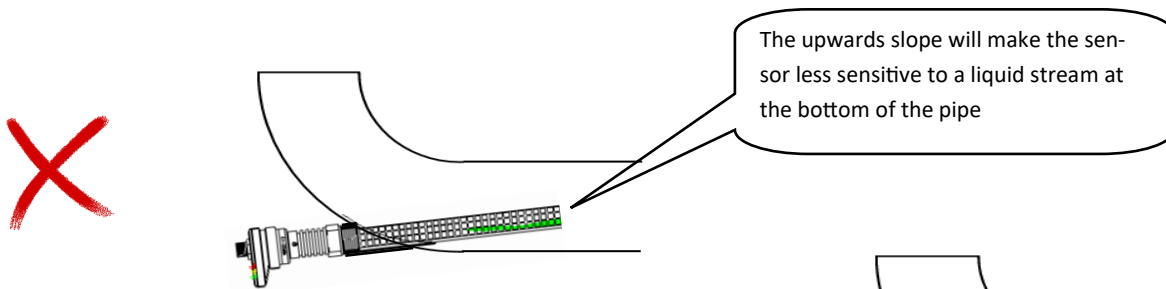
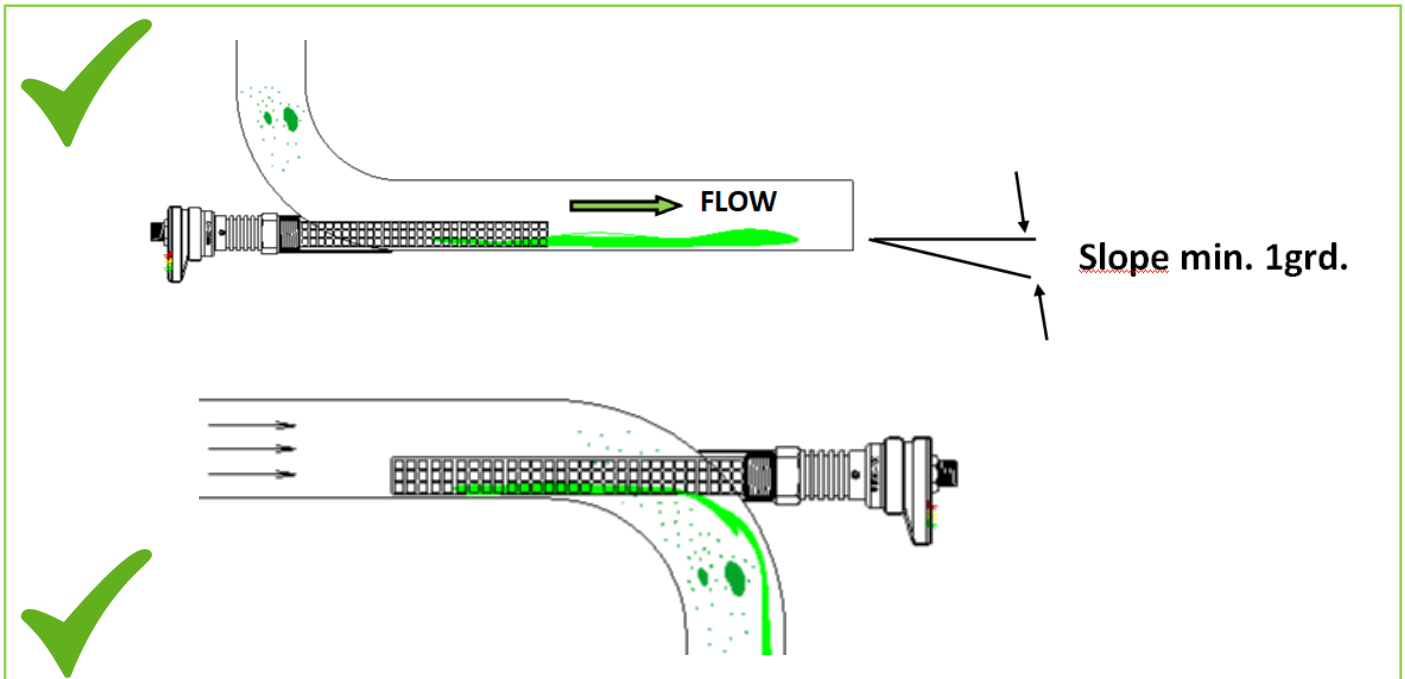

Removal of the electrical unit



The threaded union between the electronic and mechanical part allows for fast removal and remounting of the electronic element without interfering with the pressurised system. No tools are needed for the operation.

End view without electronic unit



Sensor configuration

All HBX sensors can be calibrated using a PC and a, M12 -USB cable. The software can be downloaded freely on the HB Products web page. The configuration data can be stored in the sensor and will be there until erased without power connection—just like you store data on a memory stick. When you change a value /setting there will be put a check mark next to it and that indicates you have changed something and need to store the data in the sensor.



USB configuration cable used for connecting all sensors with M12 connector to a PC with the HB tool

order code HBxC-USB



When the sensor is mounted in a refrigeration plant where it is difficult to reach or it is very cold you should consider using an M12 extension cable in your installation. This allows for configuration of your sensor where you have your M12/ M12 connection.

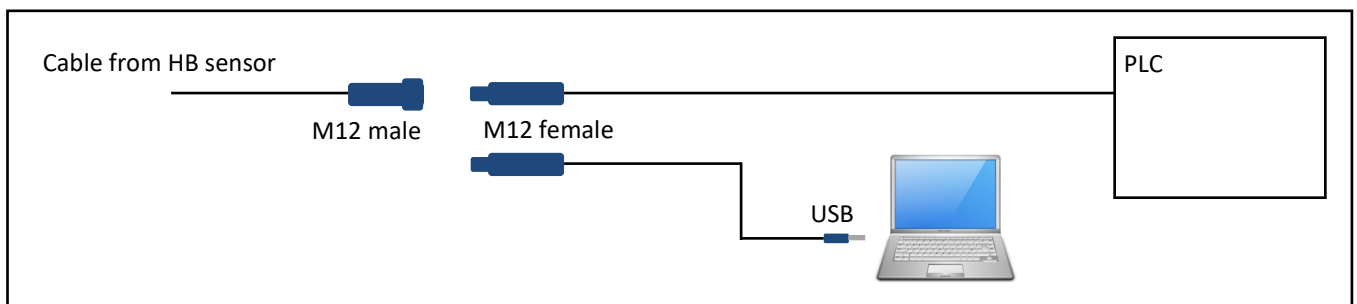

How to use the sensor

Two different versions

Two different versions exist

- A pure sensor version—without the controller capability
- A version which can both control an expansion valve with a simple input and act as a sensor together with a PLC

The sensors that are able to control an expansion valve have a cable beside the temperature sensor cable, which can be connected directly to the valve. The sensors which are specified only to provide a signal for a PLC will only have the M12 connection. All sensors, except those for NH3 refrigeration, has a cable with a PT1000 temperature sensor, which measures the operating temperature and makes the needed compensations.

Alarm application

Some of the sensors can be used for providing an alarm when the liquid level is high or if ammonia carbamate is detected. The sensor can still be used for measuring vapor quality and control a liquid valve either directly or via a PLC

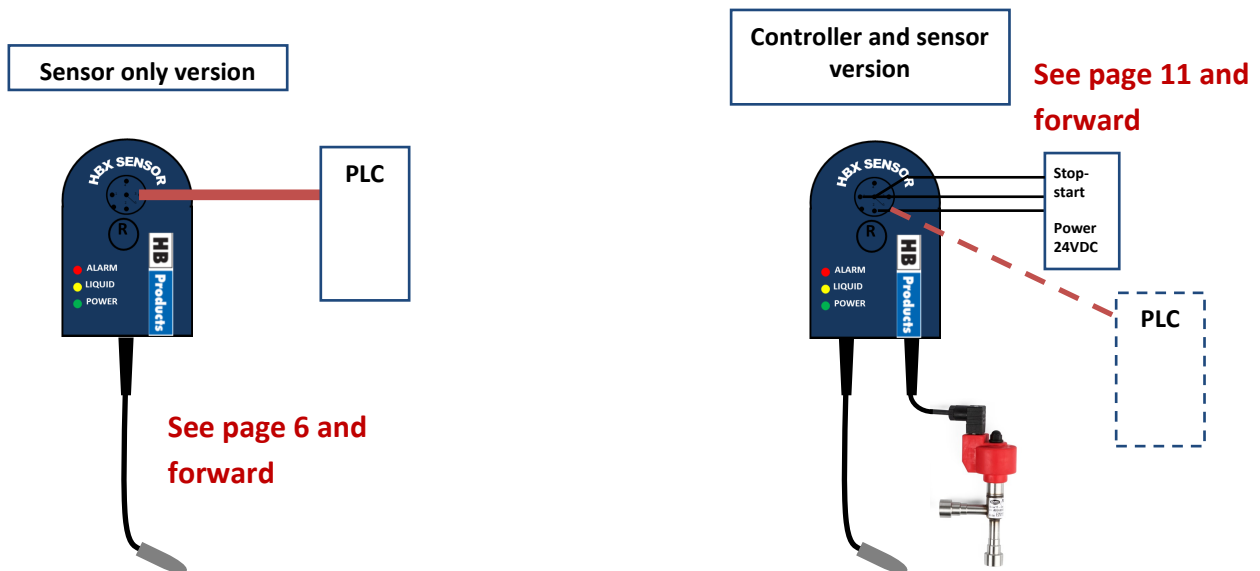

Setup — sensor or control

The sensor can operate in two very different modes

- As sensor input to a PLC, computer or other device that uses the sensor signal
- A direct controller of an electrically controlled expansion or liquid valve version with a cable output that can be set up as a controller

Select Control/Sensor to select the mode

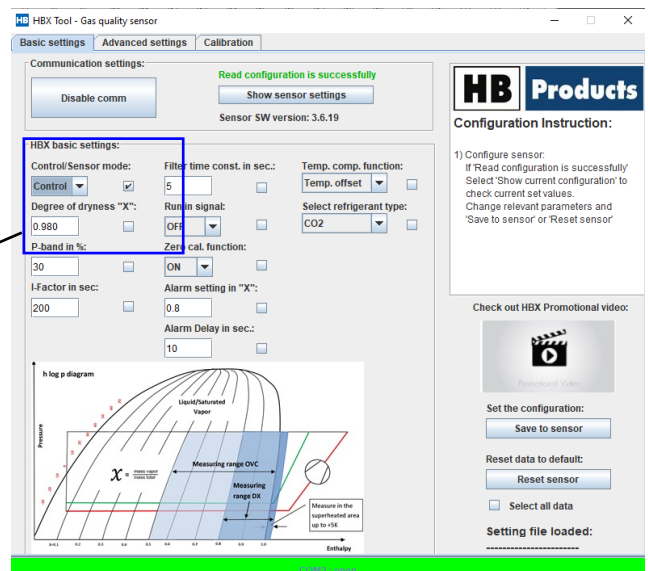
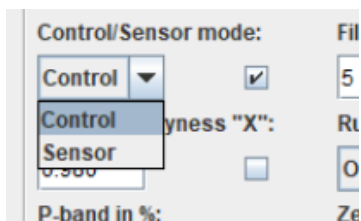

How to setup the sensor as input for PLC

When using the sensor as input to a PLC the analog output is used. The output can be scaled by adjusting a parameter. Dry gas will always be 4 mA but the "X measuring scale" found in the Calibration tab defines the 20 mA point

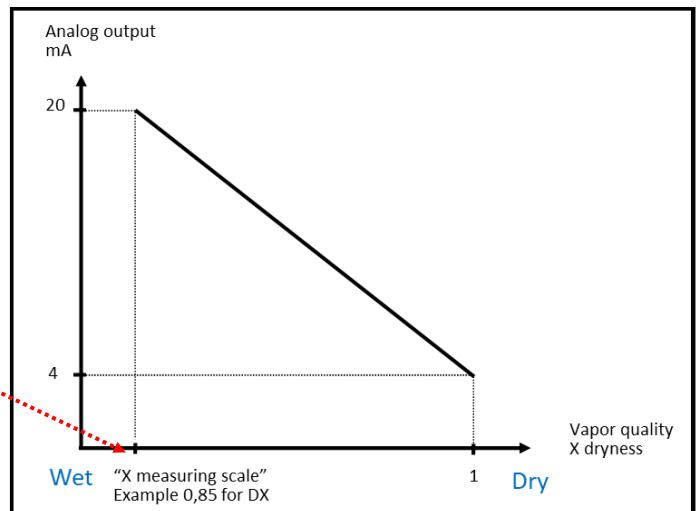
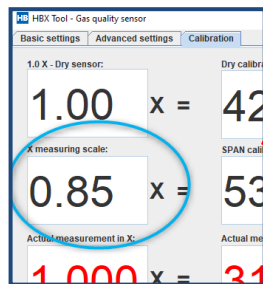

The "X measuring scale" can be changed in the calibration tab

Typical values for DX operation

When the sensor is not operating as a controller some of the parameters are irrelevant and the boxes are inactive and shown in grey.

1. Set filter time to 2 seconds. The filter time is the period of time over which the X measurement is averaged. The longer the range the smoother the measurement becomes, but the risk is that the system becomes too slow.
2. Run in signal (digital input pin 5) is used as external start and stop when operating as a controller and should be set to OFF
3. Zero cal. function: Choose "ON" if you want to use the push bottom "R" for zero calibration
4. The "Alarm setting in "X" " and "Alarm delay in seconds" can be used, but normally the alarm is programmed in the PLC directly based on the mA signal.
5. The temperature compensation function is set to "Temp offset" unless you don't want this functionality. This only applies if the sensor has a temperature sensor
6. "Select refrigerant type" is for information only and should **not** be used for changing refrigerant as it does not change the important settings, and the sensor will not provide the correct measurements. If your refrigerant is not correct you need a complete settings file - please contact HB-products for this.
7. After changing settings push the button "Save to sensor" (the message "OK" on the screen indicates that the settings are saved)
8. Go to next page: Advanced settings

Advanced settings for sensor as input for PLC

When the sensor is used as input for a PLC only the relay function can be modified in the advanced settings' tab

1. Alarm output, NO (normally open) or NC (normally closed), default is "NC" (Fail safe function)
2. After Changing settings push the button "Save to sensor" (a message "OK" on the screen indicates that the settings are saved)
3. Save settings file is used to save all the settings as a txt file
4. Load settings file is used to set up all parameters from an existing txt file (copy data to a new sensor)

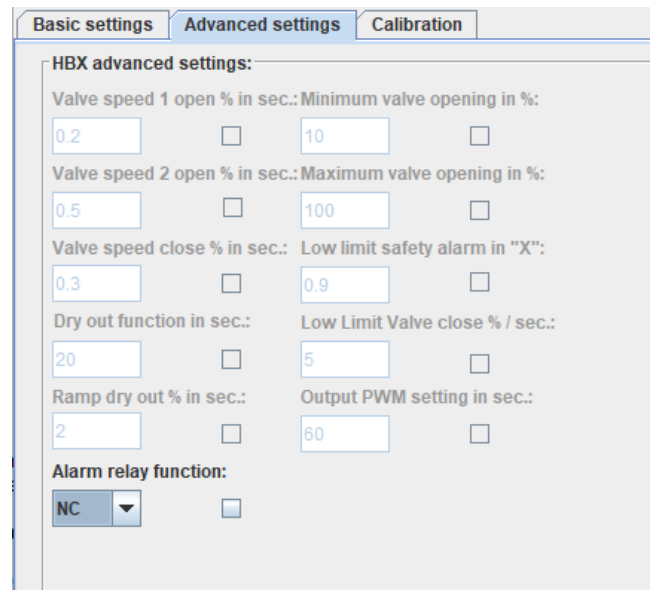

Under the calibration tab, the sensor can be set to flooded operation called "HBX-CR" or DX but it does not really matter when used for PLC input only.

How to change the "X measuring scale"

You start by ticking off the three small boxes to the right. At the same time you can change the operation range from minimum in the box called "X measuring scale" to maximum called "Dry sensor" When you are done changing the parameters, you store them in the sensor by clicking on "X scale calculation"

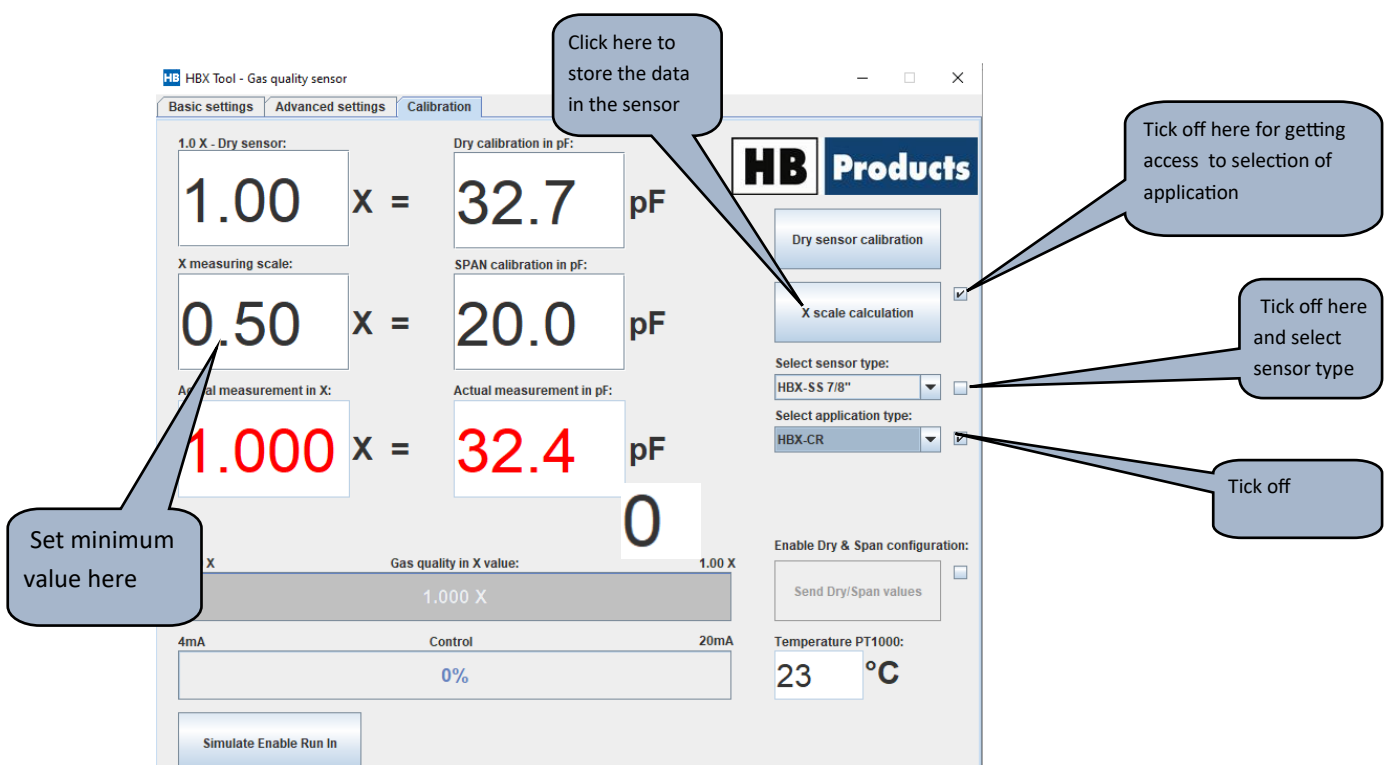

Using the sensor for flooded operation together with a PLC

The output of the sensor can be used for controlling a liquid valve directly or the analog output in pin 4 can be used as input to the PLC. The signal is scaled linearly from 4 to 20 mA where 4 mA is sent for the “dry sensor” and the 20 mA for the minimum “X measuring scale”.

An Example:

If you set the minimum to 0.50 and maximum to 1.00 you will get 16 mA for “degree of dryness “X” of 0.625

AO signal: $20 - 16 * (0.625 - 0.5) / (1.0 - 0.5) = 16 \text{ mA}$ on pin 4

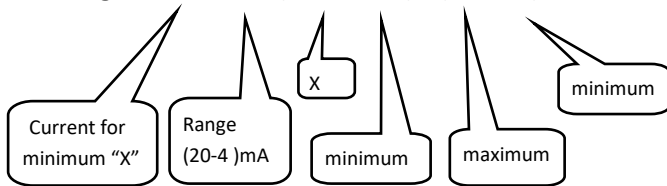

Operating a batch freezing process

Batch freezing is difficult to control due to a large capacity variation throughout the cycle. A way to control the process is to start the freezing cycle as flooded and end it as DX. It requires a PLC to control the expansion/liquid valve and make a gradual change of the circulation ratio from 3 to 1, which is equal to changing the X value from 0,3 to 1 as this formula can be used: $X = 1/CR$

The advantage of this way of controlling is increase the cooling capacity in the last part of the cycle and avoid slug flow in risers due to overfeeding. The DX operation at the end reduce the pressure drop and lowers the energy consumption.

The graph show how the X and CR value can be adjusted during the cycle.

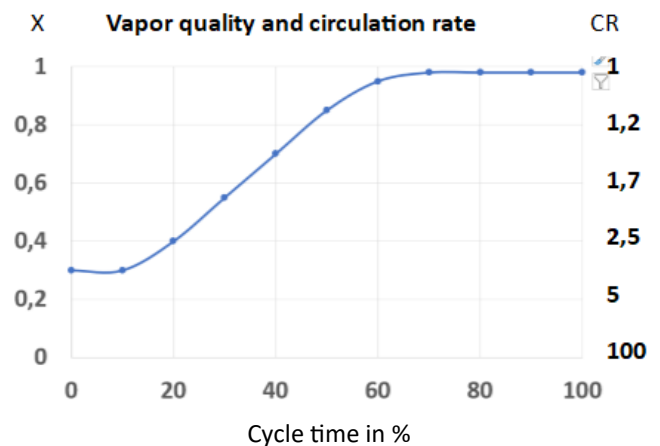

Using the alarm function for leakage control and compressor protection

Some sensors can provide a digital output signal on pin 3 when the alarm level is reached. This can be used for leakage control in a CO₂/NH₃ system where ammonia carbamate will be created or for compressor protection.

For leakage control the “Alarm setting in X” have to be set 20% below the normal operating point so for DX operation it could be 0.8.

For compressor protection the “Alarm setting in X” have to be set at around 0.95 to 0.98 depending on the system.

The “alarm delay in sec.” have to reflect the system and have to be as low as possible.

The “alarm relay function” can be adjusted to either deliver a digital output or remove the signal when the limit is passed

Basic settings

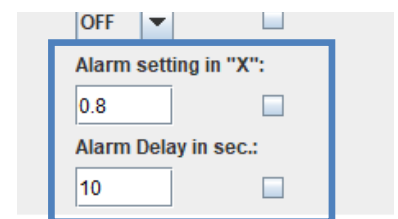

Advanced settings

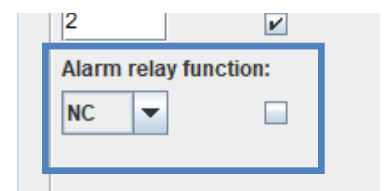

Calibration of sensor for DX operation

The sensor is delivered with a basic calibration for the refrigerant you specified when ordering. The sensor can be used directly without further calibration. You can check the calibration as described below. If the calibration is not optimal the accuracy can be improved by making a simple dry calibration at normal operating temperature, when the system has been operating for some hours. The calibration procedure is described in the section below. The calibration will depend on

- Refrigerant
- Sensor and pipe dimensions
- Operating temperature (the temperature sensor will eliminate the influence of the temperature)

How to check your calibration and make a new calibration of sensor controlling an expansion valve

1. Start your refrigeration system and let it reach normal operating temperature.
2. Make sure the sensor is completely dry which can be done in different ways depending on your system
 - If possible close the expansion valve manually and wait 1 minute for the system to evaporate all the refrigerant
 - Set the “degree of dryness “X” to 1.00 and the “Minimum valve opening in %” to 0 this is done with the HB tool as described before. Wait for 2 minutes
- a. Disconnect the M12 plug and connect a PC with the HB tool with an USB/M12 cable.
- b. Check that the control bar at the bottom of the page indicates 0%
- c. Select the “calibration” tab and you get the picture shown.
- d. Your calibration is perfect if you don’t get a lower “Actual measurement in pF” than the value stated in the field “Dry calibration in pF”. If the “Actual measurement in pF” is lower you need to make a new calibration. This is done by clicking on the “Dry sensor calibration” bottom. If the “Dry calibration in pF” still is higher than the “Actual measurement in pF” click the button once again.
- e. When the calibration is perfect, set the “degree of dryness “X” back to normal, and the “Minimum valve opening in %” to normal and then unplug the PC, reconnect the normal M12 plug .

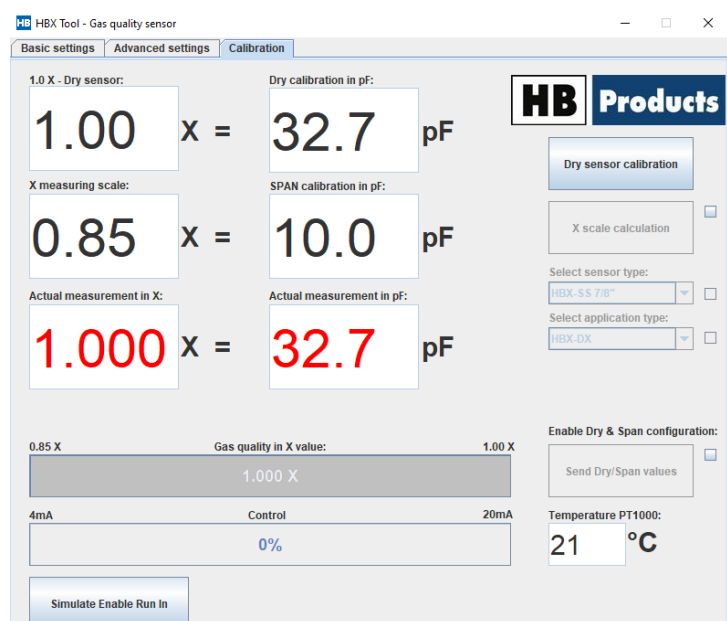

How to check your calibration and make a new calibration while sensor is connected to PLC

1. Start your refrigeration system and let it reach normal operating temperature.
2. Make sure the sensor is completely dry by closing the expansion valve manually and wait for the system to evaporate all the refrigerant
3. Read the minimum "Actual measurement in pF" either from the PLC or by connecting a PC directly to the sensor
4. Your calibration is perfect if you don't get a lower "Actual measurement in pF" than the value stated in the field "Dry calibration in pF" if the "Actual measurement in pF" is lower you need to make a calibration. This is done by clicking on the "Dry sensor calibration" button. If the "Dry calibration in pF" still is not lower than the "Actual measurement in pF" click the button once again.

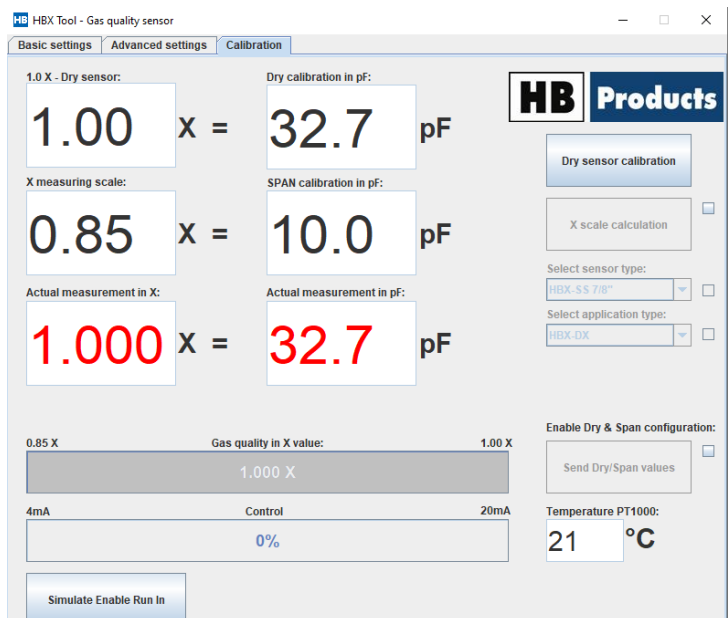

Calibration using a splitter box

When using a splitter box it is possible to run the refrigeration system and connect a PC to the sensor at the same time. The splitter box is not suited for normal operation, but only for installation and modification. The splitter box is connected to the M12 plug on the HBX sensor and then both the pc and the normal M12 plug can be connected.

Calibration of sensor operating in flooded systems

Dry calibration of the sensor is not critical when used in a flooded system and it is not needed to calibrate the sensor. If you like to do a calibration is similar to DX operation. Note before making a dry calibration the maximum "Dry sensor" X value have to be set to 1.00. If the maximum is set to a value lower than that please contact HB product support department as calibration is not straight forward and requires a special fluid or the correct gas/liquid mixture.

How does the expansion valve control loop work for DX operation

From stop to start

To start the process you need to activate the run in signal by applying 5-24 V on pin 5 when you remove the voltage the system will stop. If this signal is not set the automatic dry-out is not enabled. The run in signal should be applied when the compressor starts to benefit from the start up process with a dry out period.

Dry out period and kickstart period

The controller will open the expansion valve to dry out the sensor and start the process. This function is only active if the sensor basic setting "run in signal" is set to "ON". The idea behind the dry out and kickstart function is to ensure a rapid start up to avoid compressor cut out due to low pressure and avoid very low evaporator temperatures. The process can be started by a fast opening of the expansion valve to generate a high gas flow from the evaporator through the sensor and removing potential liquid refrigerant and oil. The opening of the expansion valve also prevents the system from shutting down due to low suction pressure.

When a plate heat exchanger is used we recommend to kickstart process to avoid freezing. Without kickstarting the very low suction pressure might result in local freezing on the secondary side and damage the heat exchanger.

The dry out run for a period specified in the parameter: "Dry out function in sec" and is ramped up with the speed set in the parameter: "Ramp dry out % in sec". When the dry out is done, ramp up to normal operation will begin. If the system usually is dry after a stop or defrost, the period can also be used as a kickstart period. This is typically needed in small system and especially in heat pumps where the compressor has a tendency to drop out due to low suction pressure. Here you can try to increase the opening until it works. Note you might hit the low level alarm limit.

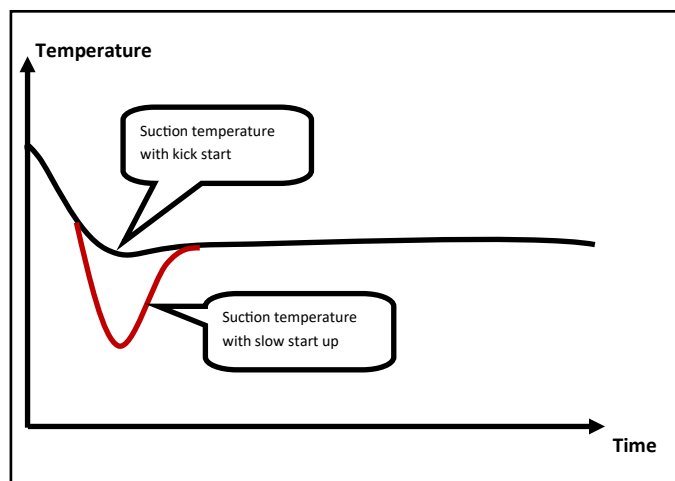

Ramping up capacity

The system will start slowly due to a PI controller which will ramp up the capacity depending on the settings. The "P-band in %" specify the target for the expansion valve opening and the "I-factor in sec" specify how long time it takes to reach the target.

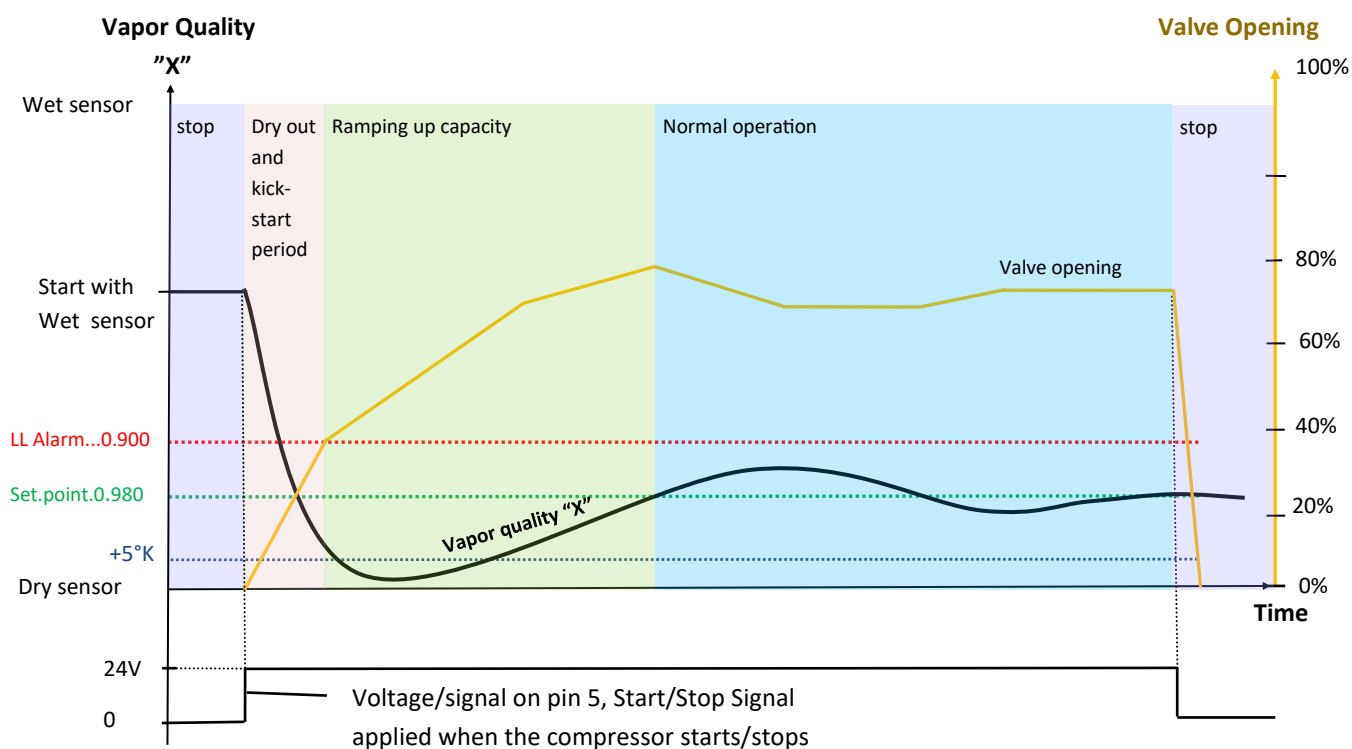

What then happens is that the controller starts opening the expansion valve at “valve speed 2 open % in sec” which means more and more liquid is sent to the evaporator. After a period the maximum capacity is reached and the HBX sensor begins to detect liquid and the opening of the expansion valve is reduced to “valve speed 1 open % in sec”. At this point the X value passes 1, where X value is a measure for the vapor quality where X=0 is all liquid and X=1 is dry gas.

With the reduced valve opening speed the capacity will still increase until the setpoint “Degree of dryness “X” ” is reached. After this point the controller will open and close the valve to maintain a stable “X” value.

Normal operation and stopping

The normal operation will continue until the system is stopped by removing the voltage on pin 5 for defrost or a regular stop. After stop, the process will restart with a new dry out period, which is important for a smooth operation.

What happens when the process is disturbed

If something happens with the complete system which results in liquid in the evaporator outlet there is a build in safety system that protects the compressor. If the sensor measures a “X” value lower than the “low limit safety alarm in “X”” the valve will be closed rapidly until setpoint “Degree of dryness “X” ” is reached again. The speed can be adjusted in the parameter: “Low Limit Valve close %/sec” and is as default set very high for safety reasons—it might lead to unstable operation. If the system has an accumulator before the compressor the “Low Limit Valve close%/sec” can be set to a lower value e.g. 0.8 instead of the default 0.9 to avoid instability. The figure below shows what happens when the low limit safety alarm is hit.

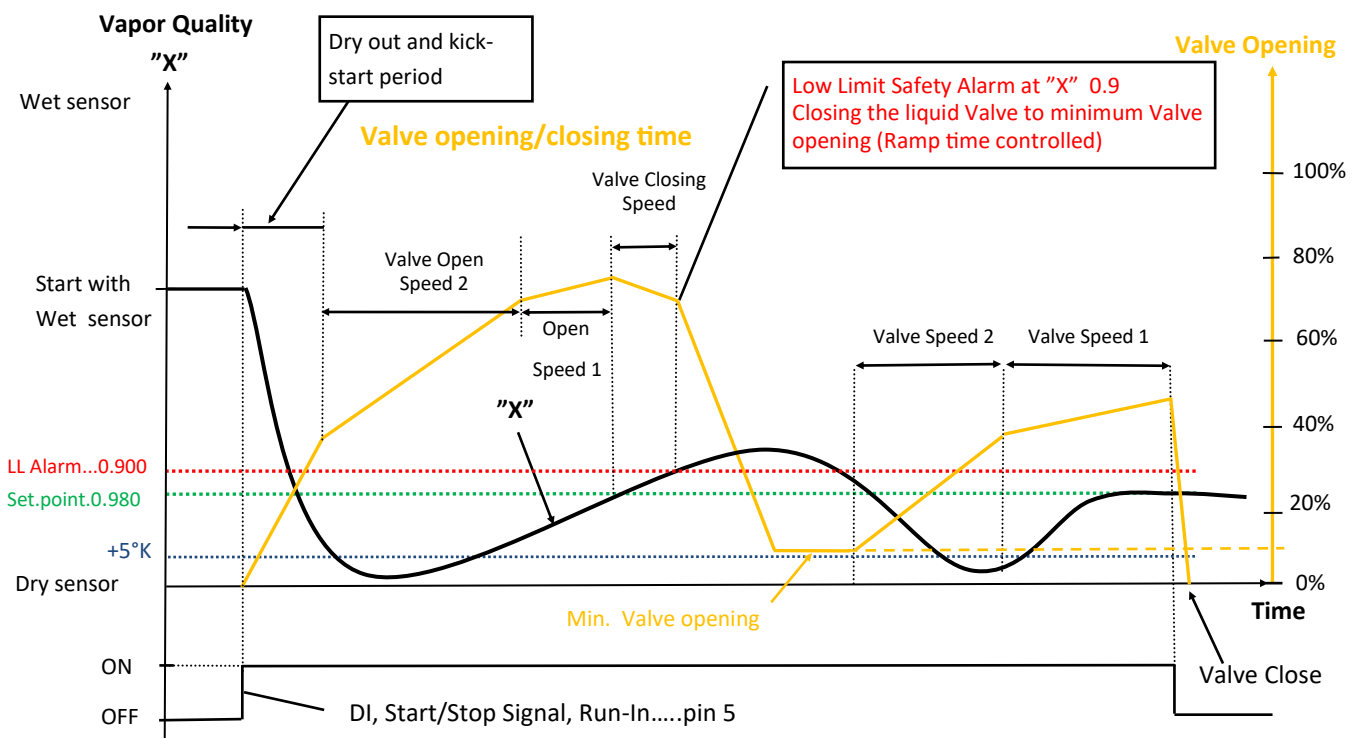

To make sure the compressor is not shut down due to too low suction pressure there is a parameter: “Minimum valve opening in %” in the system. There is also a parameter: “Maximum valve opening in %” which is there to limit the liquid injection if the valve is too large.

How does the control loop work for flooded operation

The sensor can control a liquid valve or a circulation pump directly in a similar matter as for an expansion valve in DX operation. The control loop can work with any vapor quality all the way to X=0 (all liquids) if needed.

HB-products support can help you with setting up the system.

How to setup the sensor as direct controller of an expansion valve.

Typical values for **DX operation**

1. Set the desired degree of dryness, "X" value. For DX operation a good starting point would be 0.98 the closer to 1 you go the dryer the gas will be. The X value is the Vol% of liquid
2. Set the P-band to 10% as a starting point. If the value is set higher the valve will react slower
3. Set the I-factor to 40 sec as a starting point. This means the system will ramp up over a period of 40 seconds. If the I value is set higher the system will be very slow
4. Set filter time to 5 seconds. The filter time is the period of time over which the X measurement is averaged over. Increased filter time smoothens the measurement, but the risk is that the system becomes too slow.
5. Run in signal (digital input pin 5) is used as external start and stop signal when set to "ON". This is important. If set to "OFF" the dry-out will not work and there is a risk that the control system will not really start up because the sensor is wet to begin with.
6. Zero cal. function: Choose "ON" if you want to use the push button "R" for zero calibration. Default is "OFF"
7. The "Alarm setting in "X" " is 0.8 as default, and the "Alarm delay in seconds" is as default 10 sec. The alarm is normally only used when the sensor act as leakage control or as compressor protection—see special section
8. If the sensor has a temperature sensor it has to be mounted according to the installation guide and the "Temp. comp. function" should be set to "Temp. offset" This activates the temperature compensation and gets a more accurate "X" measurement
9. "Select refrigerant type" is for information only and should **not** be used for changing refrigerant as it does not change the important settings, and the sensor will not provide the correct measurements. If your refrigerant is not correct you need a complete settings file - please contact HB-products for this.
10. After changing settings push the button "Save to sensor" (the message "OK" on the screen indicates that the settings are saved)
11. Go to next page: Advanced settings

Basic settings | **Advanced settings** | Calibration

Communication settings:

Disable comm | **Read configuration is successfully** | Show sensor settings

Sensor SW version: 3.6.19

HBX basic settings:

Control/Sensor mode: Control	Filter time const. in sec.: 5	Temp. comp. function: Temp. offset
Degree of dryness "X": 0.98	Run in signal: ON	Select refrigerant type: CO2
P-band in %: 10	Zero cal. function: OFF	
I-Factor in sec: 40	Alarm setting in "X": 0.8	
	Alarm Delay in sec.: 10	

h log p diagram

Pressure

Liquid/Saturated Vapor

$X = \frac{\text{mass vapor}}{\text{mass total}}$

Measuring range OVC

Measuring range DX

Measure in the superheated area up to +5K

Enthalpy

HB Products

Configuration Instruction:

1) Configure sensor:
If 'Read configuration is successfully' Select 'Show current configuration' to check current set values. Change relevant parameters and 'Save to sensor' or 'Reset sensor'

Check out HBX Promotional video:

Promotional Video

Set the configuration:
Save to sensor

Reset data to default:
Reset sensor

Select all data

Setting file loaded:

Advanced settings for sensor as direct controller of an expansion valve.

Basic settings
Advanced settings
Calibration

HBX advanced settings:

Valve speed 1 open % in sec.: Minimum valve opening in %:

Valve speed 2 open % in sec.: Maximum valve opening in %:

Valve speed close % in sec.: Low limit safety alarm in "X":

Dry out function in sec.: Low Limit Valve close % / sec:

Ramp dry out % in sec.:

Alarm relay function:

Stepper motor step:

Stepper motor speed in mS:

Home recal. time in hours:

Stepper motor phase current:

Stepper motor holding current:

Stepper motor settings only appear in sensors with built-in stepper motor print.

Can be used for all valve types, stepper motor settings must match manufacturer's instructions.

Displayed settings are for a Carel EV2 valve. There is an instruction manual describing how to setup and connect different valves on hbproducts.dk

If you need further help, please contact sup-port@hbproducts.dk

Set the configuration:
 Selected basic settings are also configured!! Read configuration is successfully

Save to sensor
Show sensor settings

Save settings:

Save settings file

1. Valve speed 1 opening time in sec., Default is 0.2 sec. and a good starting point
2. Valve speed 2 opening time in sec. Used for fast opening during start-up , Default is 0.5sec.
3. Valve speed closing time in sec., default is 0.3 sec. and a good starting point
4. Dry out time function in sec., This function opens the expansion valve to dry-out the sensor after a stop or defrost, and is essential for a good starting process. Default is 20 sec. and a good starting point
5. Ramp dry-out %, degree of valve opening in % per second (safe function to minimize hydraulic shock) 2 % is a good starting point. The function can also be used a kickstart function if the compressor tends to stop due to low pressure. This function is typically needed for smaller heat pumps.
6. Alarm output, NO (normally open) or NC (normally closed) , default is "NC" (Fail safe function) This setting is linked to the alarm on the previous page and is normally only used when the sensor act as leakage control or as compressor protection—se special section
7. Minimum valve opening in % (ensures against stops due to low suction pressure) 10 % is a good starting point
8. Maximum valve opening in %, normally set to 100% but a lower number is used for oversized valves
9. Low limit safety alarm in "X" value, default value is 0.9 This is a safety function which closes the expansion valve rapidly to minimum opening in order to protect the compressor. 0.9 or 0.85 are a good starting points for DX. Choose 0.85 if you have a system with large capacity variations. For flooded operation the setpoint have to be 10% lower than the "degree of dryness, "X"
10. Low limit valve close time in sec., default value is 5% per second used for fast closing when the sensor getting wet, 5% is a good starting point
11. After Changing settings push the button "Save to sensor" (a message "OK" on the screen indicates that the settings are saved)
12. Check all settings by push the button "Show sensor settings"
13. Save settings file is used to save all the settings as a txt file
14. Load settings file is used to set up all parameters from an existing .hbp file (copy data to a new sensor)The content can be read in a text program like MS word+

Controlling a flooded or semi flooded evaporator

The sensor can be used direct control of a liquid valve in an overfeed system. The settings are similar to the DX system but a few settings have to be different .

The degree of dryness "X" have to be lower and the rule of thumb is that the CR (circulation ratio) is $CR=1/"X"$ so if you aim for CR = 2 put in $1/2 = 0.5$ as The degree of dryness "X"

The remaining parameters in basic settings can be the same as for DX

For the advanced settings, the "Low limit safety alarm in "X" har to be set approx. 10 % lower than the "degree of dryness "X" . An example: for a value "degree of dryness "X" = 0.6 you choose around 0.54. If you have a system with large variations in load you need a large gap between the two values than if you have a very stabile system. If the "Low limit safety alarm in "X" is too close to the "degree of dryness "X" there is a risk that the system becomes unstable because you hit the limit and the liquid valve will close rapidly.

Under the calibration tab, the sensor has to be set to flooded operation called "HBX-CR" which is normally done at delivery. If this is not done or the sensor has to be used for another purpose it can be changed here. You start by ticking off the three small boxes to the right. Then the large input boxes come to live and you can change the application to "HBX-CR" for flooded operations and set the sensor type if wrong. At the same time you can change the operation range from minimum in the box called "X measuring scale" to maximum called "Dry sensor". When you are done changing the parameters, you store them in the sensor by clicking on "X scale calculation".

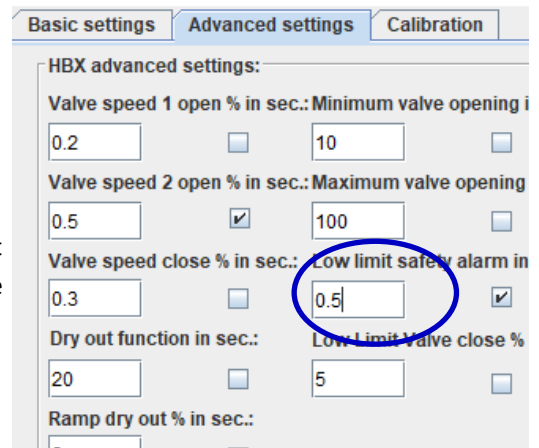
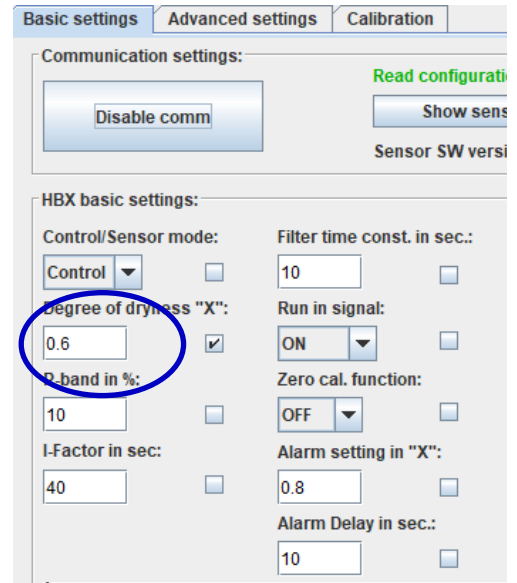

Connection diagram for HBX/S (stepper motor) with temperature compensation — here shown with Carel E2V

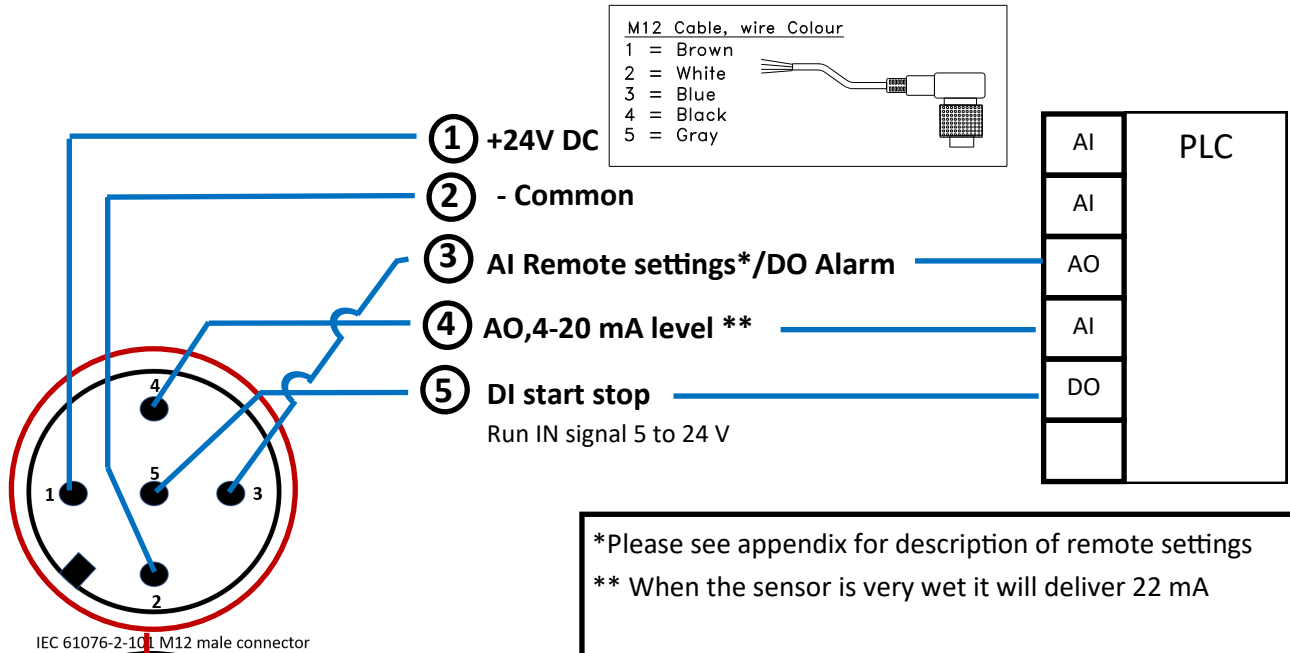

*Please see appendix for description of remote settings
 ** When the sensor is very wet it will deliver 22 mA

- Under "advanced settings" the stepper motor settings for the valve should be specified
- Analog output see page 19

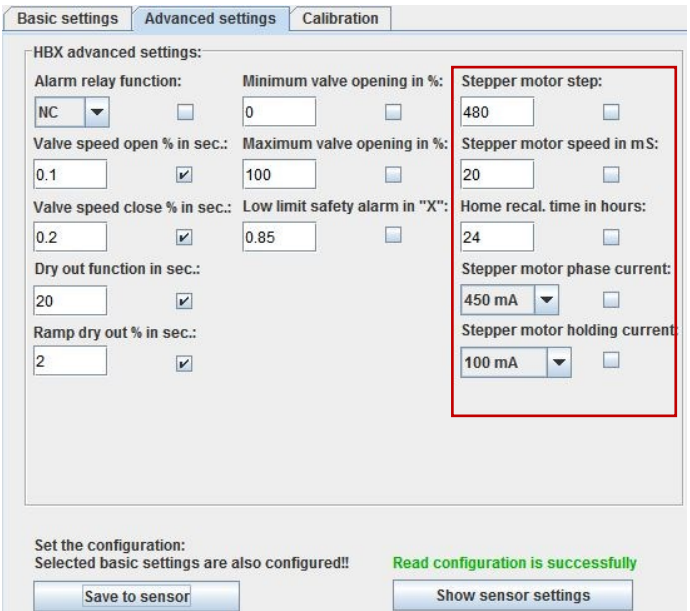
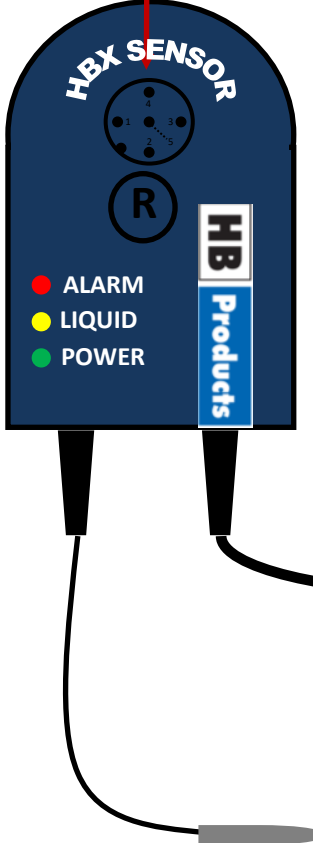

Temperature sensor PT1000
 Should be mounted on the outside of the tube in position 3 or 9 o'clock with cable ties

- Color coding**
 A+ = yellow(2)
 A- = white (4)
 B- = green (1)
 B+ = brown (3)

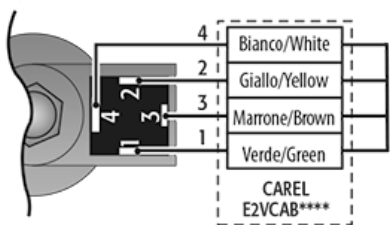

Connection diagram for HBX/C motor valve— here shown with Siemens MVS661

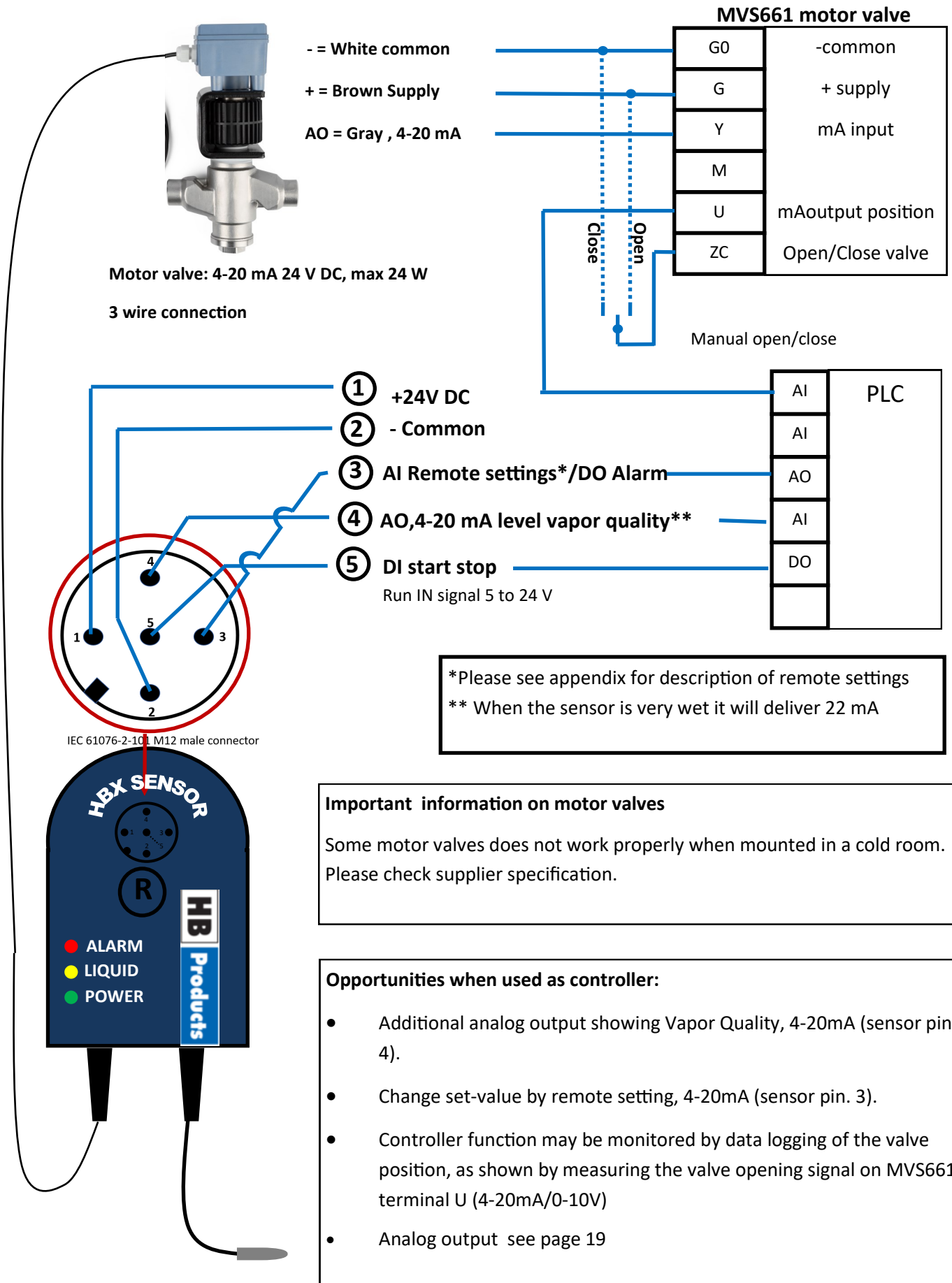

Connection diagram for HBX/PWM— pulse modulating expansion valves
Danfoss AKV/AKVA and Hansen PXV/PXVW

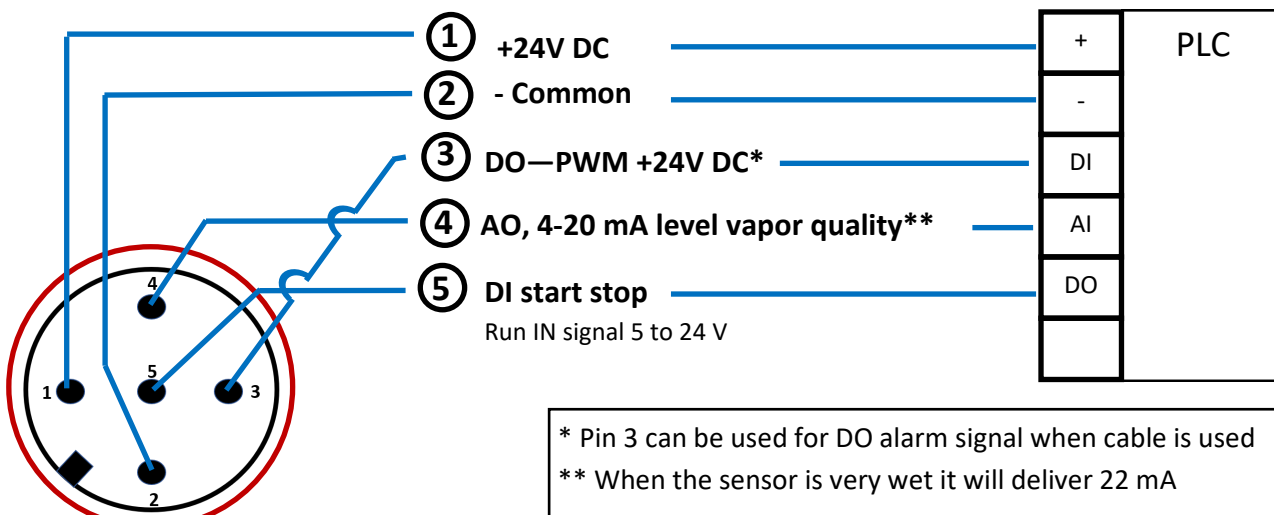
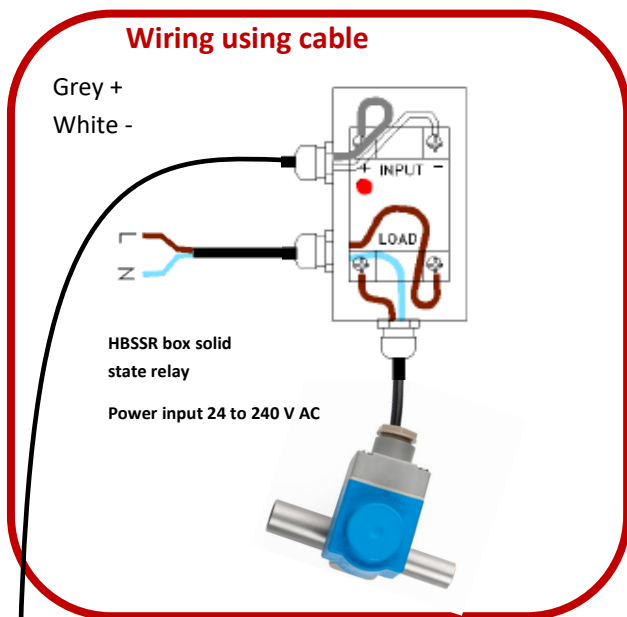

IEC 61076-2-101 M12 male connector

M12 Cable, wire Colour

1	=	Brown
2	=	White
3	=	Blue
4	=	Black
5	=	Gray

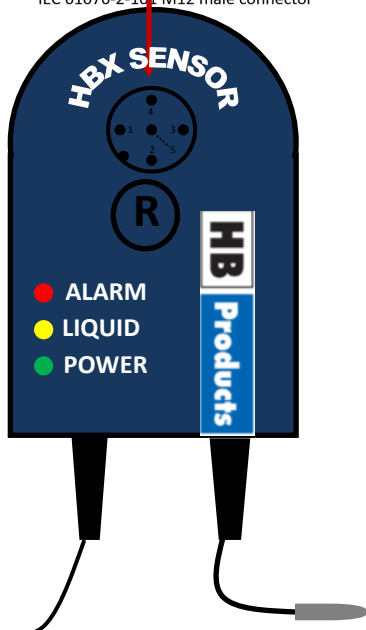

- Note:**
- HBX-DX/C-R-3-X/PWM, with valve cable for easy electrical connection.
 - HBX-DX-R-3-X/PWM, without valve cable, then the PWM output is connected to PIN3 (blue colour).
 - The HBSSR-BOX is included.

Connection diagram for sensor without control cable, connected to PLC

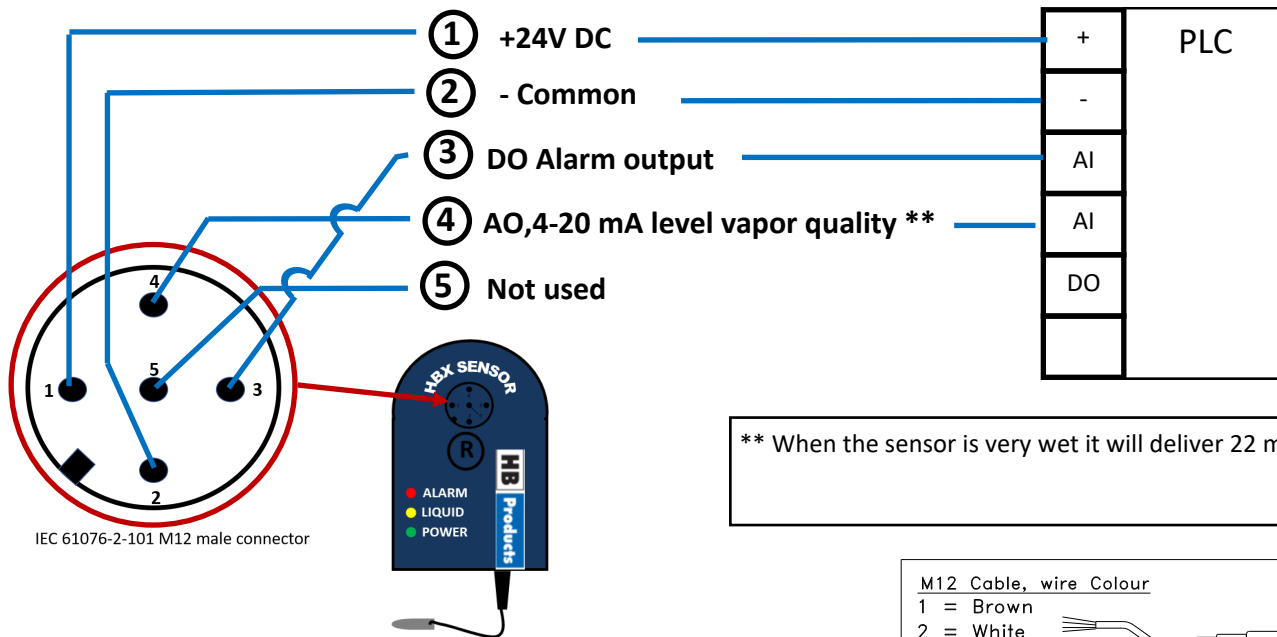

IEC 61076-2-101 M12 male connector

M12 Cable, wire Colour

1	=	Brown
2	=	White
3	=	Blue
4	=	Black
5	=	Gray

Analog output

The analog 4-20 mA output on pin 4 is linear with the "Degree of dryness "X" as shown in the table. This is similar for all types of sensors in DX operation. For flooded operation see separate section.

Degree of dryness "X"	1.00	0.99	0.98	0.97	0.96	0.95
mA value	4.00	7.20	10.40	13.60	16.80	20.00

Connection diagram for two wire Ex/ATEX/IECEx version

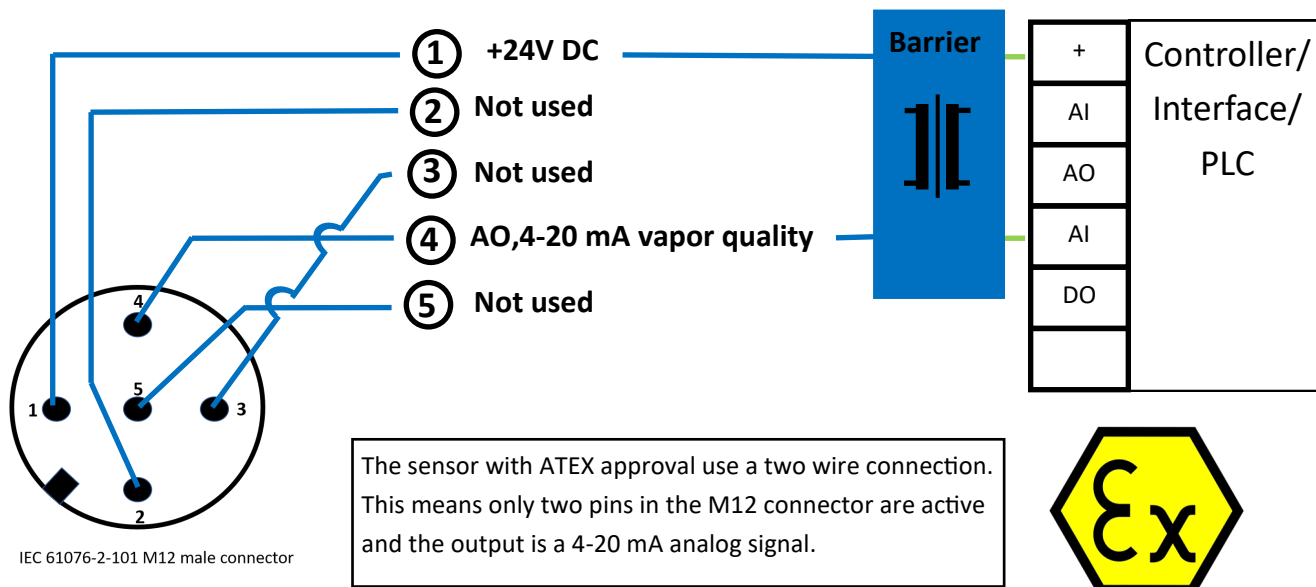

IEC 61076-2-101 M12 male connector

Remote setting (Only special versions of the sensor)

For special versions of the sensor controlling an expansion valve or a liquid valve there is a possibility to change the “degree of dryness X” dynamically from a PLC. This is done by using a function called remote setting and it is activated by selecting “Remote setpoint” in the field called “mA input function” This field is only visible for sensors with this function.

The remote setting works with a signal 4 to 20 mA applied on pin 3 in the M12 connector. When less than 4 mA is applied the prespecified “degree of dryness “X” is used

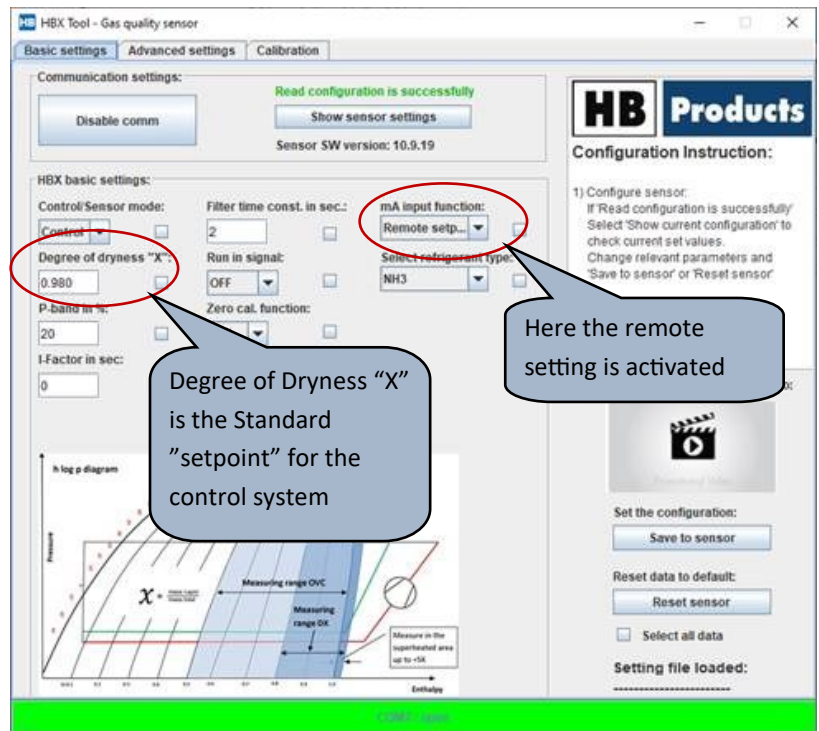

Remote setting is used when there is a need to change the desired set-point during operation.

During part load, it may be advantageous to reduce the refrigerant charge in order to get the system in better balance with higher energy efficiency and safe operation.

DX operation

In DX operation there is a fixed linear scaling between the current applied on pin 3 and “degree of dryness “X”” according to this table.

Degree of dryness “X”	1.00	0.99	0.98	0.97	0.96	0.95
mA value	4.00	7.20	10.40	13.60	16.80	20.00

Flooded and CR operation

Here it is possible to move the setpoint “degree of dryness “X”” all the way down to 0 equal to liquid only.

Start by selecting application to CR.

You key in the minimum in the field called “X measuring scale” and the maximum in “Dry sensor”. Minimum is equal to 20 mA and 4 mA is equal to maximum.

An Example:

If you set the minimum to 0.55 and like to reach a set point “degree of dryness “X”” of 0.8 you need to apply

$$\text{Remote signal: } 20 - 16 * (0.8 - 0.55) / (1 - 0.55) = 7,5 \text{ mA}$$

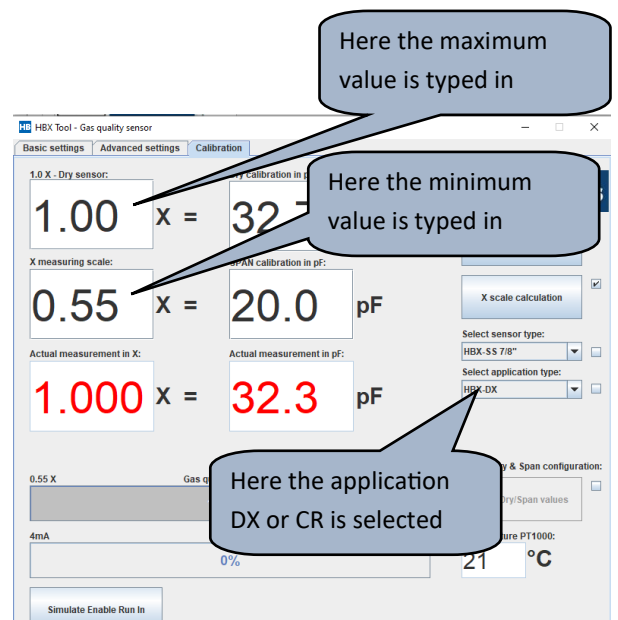
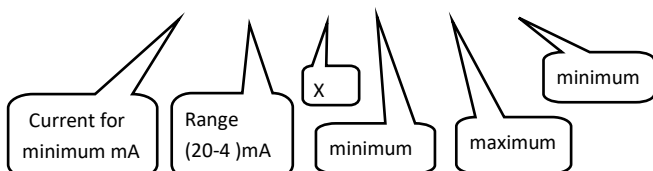

The LED indications on sensor head

The electronic element has build in LED's red, yellow and green and they will light up depending of the conditions and can be used for diagnostics. The table shows the different indications:

LED light	Appearance	Functionality
Green	ON	The HBX sensor is on. It gives analog feedback to the PLC, but it is not controlling the expansions valve (the valve is turned off)
	Flashing	The sensor is on. It gives analog feedback to the PLC, and controls the expansion valve (The sensor receives a Run-in signal (Digital input))
	OFF	The sensor is not receiving power
Green and Red	Flashing Individually	There is no connection between mechanical- and electrical part
Yellow	Flashing	The flashing sequence indicates if the valve is opening or closing: Long time between flashes= The valve is barely open Short time between flashes = The valve is "much" open
Red	ON	The ammonia is too wet
	Flashing (one pr. sec)	The sensor detects a lot of liquid. The sensor will give 22-24mA
	Flashing (two pr. sec.)	The sensor is connected with USB-cable
Red and Yellow	Flashing at the same time (two pr. sec.)	The splitter box is connected
Red, yellow and green	Red Flashing (two pr. sec.) Yellow flashing (one pr. sec) Green constant on	The sensor is connected with USB-cable

Use of the sensor with other refrigerants

The sensor must be ordered for a specific refrigerant. It is possible to change the sensor to work with another refrigerant, but a full package of new settings have to be uploaded. HB products has the setting files for most refrigerants and you can get them on request. The refrigerant the sensor is specified for can be found under the basic settings tab. Please note that the list of refrigerants is not complete and the sensor might be specified for instance for CO2 and can be used for R290 as an example.

Contact HBproducts support if you need more information

Email: support@hbproduct.dk

Telephone : +45 8747 6200